



Catalogue

Version 2018

Solide Carbide Milling



ZCC Cutting Tools Europe GmbH

your Partner | your Value



WELCOME TO ZCC CUTTING TOOLS EUROPE

ZCC-CT, one of the World's leading carbide tooling manufacturers, welcomes you to its products. We are able to offer you a wide product range of high performance cutting tools at economic prices and a good supply service to support the production and productivity at your manufacturing facilities. You will find the main tool types in the various sections of the catalogue, Turning is in section A, Milling in section B and Drilling in section C of the catalogue.

We are looking forward to working with you and developing good cooperation together. Our team at ZCC Cutting Tools Europe is ready to support you in all of your requirements.





Member of Minmetals Group



HAUPTSITZ IN EUROPA:

ZCC Cutting Tools Europe GmbH, Wanheimer Str.57, 40472 Düsseldorf, Germany

Tel.: +49 (0) 211/989240-0, Fax: +49 (0) 211/ 989240-111

E-Mail: info@zccct-europe.com, www.zccct-europe.com, www.zccct.com



Copyright Katalog
©2016 ZCC Cutting Tools Europe GmbH

All rights reserved. All descriptions and pictures are protected by copyright. Usage, modification and reproduction, completely or partially, without written permission are prohibited. Subject to technical changes and changes of the delivery program. Mistakes and printing errors are reserved.



Turning**A**

General turning

A1-A336

Parting & grooving

A337-A402

Threading

A403-A455

Milling**B**

Indexable milling

B1-B248

Solid carbide milling

B249-B462

Drilling**C**

Indexable drills

C1-C24

Solid carbide drills

C25-C126

Solid carbide reamers

C127-C140

Solid carbide threading tools

C141-C182

Technical information**D**

D1-D24

Index**E**

E1-E8



A

Turning

B

Milling

C

Drilling

DTechnical
Information**E**





















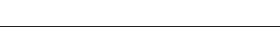

Index

B



















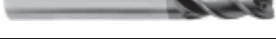
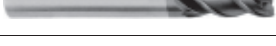

Solid carbide milling

Product overview	B250-B256
Grade overview	B257
System code – DIN-ISO series	B258
System code – JIS series	B259-B260
GM series	B261-B318
PM series	B319-B342
HM series	B343-B366
NM series	B367-B374
AL series	B375-B392
HPC series	B393-B400
UM series	B401-B410
VSM series	B411-B416
Deburring cutters – FM series	B417-B421
Recommended cutting data	B422-B446
Technical information	B457-B460
Form nonstandard order	B461-B462

- A
- Turning
- B
- Milling
- C
- Drilling
- D
- Technical Information
- E
- Index

	Products	Solid carbide cutters	Teeth	Ø	Application						Type	Page
					P	M	K	N	S	H		
High performance milling	PM-2E		2	1.0-20.0	✓	✓	✓			✓	End mills	B320
	PM-2EL		2	3.0-20.0	✓	✓	✓			✓	End mills	B321
	PM-4E-G		4	1.0-20.0	✓	✓	✓			✓	End mills	B322
	PM-4EL-G		4	3.0-20.0	✓	✓	✓			✓	End mills	B323
	PM-4EX-G		4	3.0-20.0	✓	✓	✓			✓	End mills	B324
	PM-4E		4	1.0-20.0	✓	✓	✓			✓	End mills	B325
	PM-4EL		4	3.0-20.0	✓	✓	✓			✓	End mills	B326
	PM-6E		6	6.0-20.0	✓	✓	✓			✓	End mills	B327
	PM-6EL		6	6.0-20.0	✓	✓	✓			✓	End mills	B328
	PM-2B		2	1.0-20.0	✓	✓	✓			✓	Ball nose cutters	B329
	PM-2BL		2	2.0-20.0	✓	✓	✓			✓	Ball nose cutters	B330
	PM-2BFP		2	1.0-20.0	✓	✓	✓			✓	Ball nose cutters	B331
	PM-2BC		2	0.5-4.0	✓	✓	✓			✓	Ball nose cutter with conical neck	B332
	PM-4B		4	3.0-20.0	✓	✓	✓			✓	Ball nose cutters	B335
	PM-4BL		4	3.0-20.0	✓	✓	✓			✓	Ball nose cutters	B336
	PM-2R		2	1.0-12.0	✓	✓	✓			✓	Torus mills	B337
	PM-4R		4	3.0-12.0	✓	✓	✓			✓	Torus mills	B340
	PM-4RL		4	6.0-16.0	✓	✓	✓			✓	Torus mills	B341
	PM-4H		4	3.0-12.0	✓	✓	✓			✓	High-feed mills	B338
	PM-4HL		4	4.0-12.0	✓	✓	✓			✓	High-feed mills	B339
General machining	5501R302GM		2	3.0-20.0	✓	✓	✓				End mills	B262
	5601R302GM		2	3.0-20.0	✓	✓	✓				End mills	B263
	5502R302GM		2	1.0-20.0	✓	✓	✓				End mills	B264

✓ Very suitable ✓ Suitable

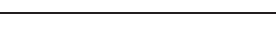
	Products	Solid carbide cutters	Teeth	Ø	Application						Type	Page
					P	M	K	N	S	H		
General machining	5602R302GM		2	2.0-20.0	✓	✓	✓				End mills	B266
	GM-2E		2	1.0-20.0	✓	✓	✓				End mills	B267
	GM-2EL		2	3.0-20.0	✓	✓	✓				End mills	B268
	GM-2EX		2	3.0-20.0	✓	✓	✓				End mills	B269
	GM-2EFP		2	6.0-16.0	✓	✓	✓				End mills	B270
	GM-2F		2	1.0-20.0	✓	✓	✓				End mills	B271
	GM-2FL		2	3.0-20.0	✓	✓	✓				End mills	B272
	GM-2EP		2	5.0	✓	✓	✓				Mini end mills	B273
	GM-2ES		2	3.0	✓	✓	✓				Mini end mills	B275
	GM-3E		3	1.0-20.0	✓	✓	✓				End mills	B276
	GM-3EL		3	3.0-20.0	✓	✓	✓				End mills	B277
	5501R303GM		3	3.0-20.0	✓	✓	✓				End mills	B278
	5601R303GM		3	3.0-20.0	✓	✓	✓				End mills	B279
	5502R303GM		3	3.0-20.0	✓	✓	✓				End mills	B280
	5602R303GM		3	3.0-20.0	✓	✓	✓				End mills	B281
	5502R453GM		3	3.0-20.0	✓	✓	✓				End mills	B282
	5602R453GM		3	3.0-20.0	✓	✓	✓				End mills	B283
	GM-4E-G		4	1.0-20.0	✓	✓	✓				End mills	B289
	GM-4F-G		4	1.0-20.0	✓	✓	✓				End mills	B284
	GM-4EL-G		4	3.0-20.0	✓	✓	✓				End mills	B285
GM-4FL-G		4	3.0-16.0	✓	✓	✓				End mills	B286	
GM-4EX-G		4	3.0-20.0	✓	✓	✓				End mills	B287	
GM-4E		4	1.0-20.0	✓	✓	✓				End mills	B288	

✓ Very suitable ✓ Suitable



A
 Turning
B
 Milling
C
 Drilling
D
 Technical Information
E
 Index

A

Turning

B

Milling

C













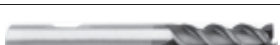

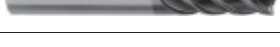





Drilling

D















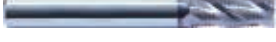

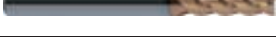

Technical Information

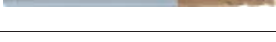
E

Index

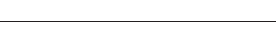
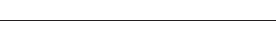
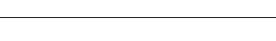
	Products	Solid carbide cutters	Teeth	Ø	Application						Type	Page
					P	M	K	N	S	H		
General machining	GM-4EL		4	3.0-20.0	✓	✓	✓				End mills	B290
	GM-4EFP		4	6.0-20.0	✓	✓	✓				End mills	B291
	5501R304GF		4	3.0-20.0	✓	✓	✓				End mills	B292
	5601R304GF		4	3.0-20.0	✓	✓	✓				End mills	B293
	5502R304GF		4	3.0-20.0	✓	✓	✓				End mills	B294
	5602R304GF		4	3.0-20.0	✓	✓	✓				End mills	B295
	5508R454GM		4	3.0-20.0	✓	✓	✓				End mills	B296
	5602R454GM		4	3.0-20.0	✓	✓	✓				End mills	B297
	5589R45MGFR02		6-10	6.0-20.0	✓	✓	✓				End mills	B298
	GM-6E		6	6.0-20.0	✓	✓	✓				End mills	B299
	GM-6EL		6	6.0-20.0	✓	✓	✓				End mills	B300
	5565R302GF		2	3.0-20.0	✓	✓	✓				Ball nose cutters	B301
	5665R202GM		2	3.0-20.0	✓	✓	✓				Ball nose cutters	B302
	5566R302GF		2	3.0-12.0	✓	✓	✓				Ball nose cutters	B303
	GM-2B		2	1.0-20.0	✓	✓	✓				Ball nose cutters	B304
	GM-2BL		2	2.0-20.0	✓	✓	✓				Ball nose cutters	B305
	GM-2BFP		2	1.0-20.0	✓	✓	✓				Ball nose cutters	B306
	GM-2BS		2	3.0	✓	✓	✓				Mini ball nose cutters	B307
	GM-2BP		2	5.0	✓	✓	✓				Mini ball nose cutters	B308
	GM-4B		4	3.0-20.0	✓	✓	✓				Ball nose cutters	B310
GM-4BL		4	3.0-20.0	✓	✓	✓				Ball nose cutters	B311	
GM-2R		2	1.0-12.0	✓	✓	✓				Torus mills	B312	

✓ Very suitable ✓ Suitable

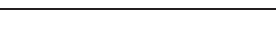
	Products	Solid carbide cutters	Teeth	Ø	Application						Type	Page
					P	M	K	N	S	H		
General machining	GM-4R		4	3.0-12.0	✓	✓	✓				Torus mills	B313
	GM-4RL		4	6.0-16.0	✓	✓	✓				Torus mills	B314
	5602R303GR		3	6.0-8.0	✓	✓	✓				Rippers	B315
	5602R304GR		4	10.0-20.0	✓	✓	✓				Rippers	B316
	5602R305GR		5	25.0	✓	✓	✓				Rippers	B317
	GM-4W		4	6.0-20.0	✓	✓	✓				Rippers	B318
Machining high hardness steel	HM-2E		2	1.0-20.0						✓	End mills	B344
	HM-2EFP		2	6.0-20.0						✓	End mills	B345
	HM-2EP		2	5.0						✓	Mini end mills	B346
	HM-2ES		2	3.0						✓	Mini end mills	B348
	HM-4E		4	1.0-20.0						✓	End mills	B349
	HM-4EL		4	3.0-20.0						✓	End mills	B350
	HM-4EFP		4	6.0-20.0						✓	End mills	B351
	5502R55MHH		4-8	3.0-20.0						✓	End mills	B352
	HM-6E		6	6.0-20.0						✓	End mills	B353
	HM-6EL		6	6.0-20.0						✓	End mills	B354
	HM-2B		2	1.0-20.0						✓	Ball nose cutters	B355
	HM-2BL		2	2.0-20.0						✓	Ball nose cutters	B356
	HM-2BFP		2	1.0-20.0						✓	Ball nose cutters	B357
	HM-2BS		2	3.0						✓	Mini ball nose cutters	B358
	HM-2BP		2	5.0						✓	Mini ball nose cutters	B359
	HM-4B		4	3.0-20.0						✓	Ball nose cutters	B361
HM-4BL		4	3.0-20.0						✓	Ball nose cutters	B362	

✓ Very suitable ✓ Suitable

A

Turning

B

Milling

C

Drilling

D

Technical Information

E

Index

A

Turning

B

Milling

C























Drilling

D























Technical Information

E

Index

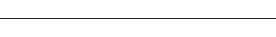
	Products	Solid carbide cutters	Teeth	Ø	Application						Type	Page
					P	M	K	N	S	H		
Machining high hardness steel	HM-4R		4	3.0-12.0						✓	Torus mills	B363
	HM-4RF		4	6.0-12.0						✓	Torus mills	B364
	HM-4RP		4	6.0-16.0						✓	Torus mills	B365
Copper and copper alloys	5502R402NM		2	3.0-20.0				✓			End mills	B368
	NM-2E		2	1.0-12.0				✓			End mills	B369
	NM-2EP		2	5.0				✓			Mini end mills	B370
	NM-4E		4	3.0-12.0				✓			End mills	B371
	NM-2B		2	1.0-12.0				✓			Ball nose cutters	B372
	NM-2BP		2	5.0				✓			Mini ball nose cutters	B373
Aluminium and aluminium alloys	AL-2E		2	1.0-20.0				✓			End mills	B376
	AL-2EL		2	3.0-20.0				✓			End mills	B377
	ALG-2E		2	1.0-20.0				✓			End mills	B378
	ALG-2R		2	6.0-25.0				✓			Torus mills	B390
	AL-3E		3	1.0-20.0				✓			End mills	B379
	AL-3EL		3	3.0-20.0				✓			End mills	B380
	ALG-3E		3	1.0-20.0				✓			End mills	B381
	ALP-3E		3	1.0-20.0				✓			End mills	B382
	ALP-4E		4	3.0-20.0				✓			End mills	B383
	AL-3W		3	6.0-20.0				✓			Rippers	B384
	5565R302NH		2	3.0-16.0				✓			Ball nose cutters	B385
	5566R302NH		2	3.0-16.0				✓			Ball nose cutters	B386
	AL-2B		2	2.0-12.0				✓			Ball nose cutters	B387

✓ Very suitable ✓ Suitable

	Products	Solid carbide cutters	Teeth	Ø	Application						Type	Page
					P	M	K	N	S	H		
Aluminium and aluminium alloys	AL-2R-AIR		2	6.0-20.0				✓			High performance torus mills	B388
	AL-2RL-AIR		2	6.0-20.0				✓			High performance torus mills	B389
	AL-3R-AIR		3	12.0-20.0				✓			High performance torus mills	B391
	AL-3RL-AIR		3	12.0-20.0				✓			High performance torus mills	B392
HPC with unequal helix angle	5501R38414GM		4	4.0-20.0	✓	✓	✓			✓	End mills	B394
	5502R38414GM		4	4.0-20.0	✓	✓	✓			✓	End mills	B395
	5601R38414GM		4	4.0-20.0	✓	✓	✓			✓	End mills	B396
	5602R38414GM		4	4.0-20.0	✓	✓	✓			✓	End mills	B397
	5502R38414GM-R		4	4.0-20.0	✓	✓	✓			✓	Torus mills	B398
	5602R38414GM-R		4	4.0-20.0	✓	✓	✓			✓	Torus mills	B399
	UM-4E		4	4.0-20.0	✓	✓	✓			✓	End mills	B402
	UM-4E-W		4	4.0-20.0	✓	✓	✓			✓	End mills	B403
	UM-4EL		4	4.0-20.0	✓	✓	✓			✓	End mills	B404
	UM-4EL-W		4	4.0-20.0	✓	✓	✓			✓	End mills	B405
	UM-4ELP-W		4	4.0-20.0	✓	✓	✓			✓	End mills	B406
	UM-4EFP		4	6.0-20.0	✓	✓	✓			✓	End mills	B407
	UM-4R		4	4.0-20.0	✓	✓	✓			✓	Torus mills	B408
	UM-4RL		4	6.0-16.0	✓	✓	✓			✓	Torus mills	B409
	UM-4RFP		4	6.0-16.0	✓	✓	✓			✓	Torus mills	B410
	VSM-4E		4	4.0-20.0	✓	✓			✓		End mills	B412
VSM-4E-C		4	8.0-20.0	✓	✓			✓		End mills	B413	
VSM-4R		4	4.0-20.0	✓	✓			✓		Torus mills	B414	

✓ Very suitable ✓ Suitable

A

Turning

B

Milling

C

Drilling

D



Technical Information

E

Index

A

Turning

	Products	Solid carbide cutters	Teeth	Ø	Application						Type	Page
					P	M	K	N	S	H		
Deburring cutter	5501/5601		3-4	3.0-16.0	✓	✓	✓	✓			Deburring cutters	B418
	5501/5601		3-4	3.0-16.0	✓	✓	✓	✓			Deburring cutters	B419
	5601		4	5.2-10.0	✓	✓	✓	✓			Deburring cutters	B420

✓ Very suitable ✓ Suitable

B

Milling

C

Drilling

D

Technical Information

E

Index

Coated cemented carbide PVD

Grade	Grade description
KMG303	PVD coated carbide substrate for universal milling application of steel (up to HRC≤48), stainless steel and cast iron.
KMG405	PVD coated carbide substrate for high performance milling application of steel (up to HRC <55), stainless steel, super alloy material and cast iron. High wear resistance and toughness for a wide application field.
KMG555	PVD coated carbide substrate for hard milling application of steel (HRC 55–68), highest wear resistance and toughness for best cutting result.
KMG309	PVD coated carbide substrate for non ferrous materials. High wear resistance even in abrasive materials.

Uncoated cemented carbide

Grade	Grade description
YK30F	Uncoated K30 carbide substrate for steel, stainless steel, cast iron and non ferrous materials.
YK40F	Uncoated K20–K30/N20–N30 carbide substrate for cast iron and non ferrous materials.

A

Turning

B

Milling

C

Drilling

D

Technical
Information

E

Index

5 5 0 1 R 30 2 GM R05 0800

1 2 3 4 5 6 7 8 9 10

Type	
Code	Description
5	Milling cutter

Shank type	
Code	Description
1	Shank
5	DIN 6535 HA
6	Weldon shank DIN 6535 HB
7	Whistle Notch DIN 6535 HE
9	Morse taper shank

Cutting edge type	
Code	Description
0	Square shoulder mill
6	Ball nose cutter
8	Torus mill

1

2

3

Tool length	
Code	Description
1	DIN 6527 K
2	DIN 6527 L
5	Factory standard ZCC-A
6	Factory standard ZCC-B
8	DIN 6528
9	Factory standard ZCC-D

Rotation direction	
Code	Description
R	Right
L	Left

Helix angle	
Code	Description
20	20°
30	30°
3841	38°/41°
45	45°
55	55°
60	60°

No. of teeth	
Code	Description
2	2
...	
M	Indicated when different diameters have a different number of teeth

4

5

6

7

Application	
Code	Description
GM	Semi-finishing
GF	Finishing
HM	Hard machining
MHH	High-speed hard machining
NH	High-performance machining of heat-resistant alloys

Radius [mm]	
Code	Description
R03	0.3
R15	1.5
R30	3.0
...	



Diameter [mm]	
Code	Description
0100	1.0
0800	8.0
2000	20.0
...	

8

9

10

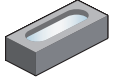
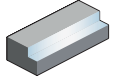
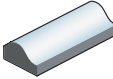
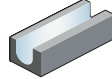
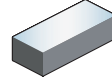
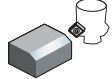
Machining operations

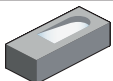
					
Groove milling	Square shoulder milling	Profile milling	Slot milling	Face milling	Chamfer milling
					
Plunge milling	Circular milling/ Ramping				

GM – 2 E L P – D12 R0.5 – M08

1 2 3 4 5 6 7 8

Application	
Code	Description
GR	General roughing
GM	Semi-finishing
GF	Finishing
PM	High-performance machining
HM	Hard machining
HH	High-speed hard machining
NM	General machining of non-ferrous metals
AL	General machining of Al and Al alloys
ALP	High-performance machining of Al and Al alloys
ALG	General machining of Al and Al alloys
UM	HSC/HPC machining
VSM	General machining of heat-resistant alloys

No. of teeth

Cutting edge type	
Code	Description
E	Square shoulder mill with protective chamfer
F	Square shoulder mill with sharp cutting edges
B	Ball nose cutter
R	Torus mill
W	Ripper
H	High-feed mill

1 2 3

Cutting edge length	
Code	Description
L	Long
X	Extra long
F	Short

Type	
Code	Description
S	Mini diameter
P	Grounded neck
C	Conical neck



Diameter [mm]	
Code	Description
D3.0	3.0
D8.0	8.0
D20.0	20.0
...	

Radius [mm]	
Code	Description
R0.5	0.5
R1.0	1.5
R3.0	3.0
...	

4 5 6 7

Features	
Code	Description
G	Spiral angle 30°
M	Neck length [mm]
S	Thin shank
AIR	For aerospace industry

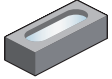
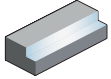
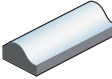
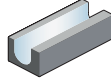
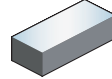
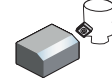
8

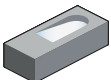
Machining operations					
					
Groove milling	Square shoulder milling	Profile milling	Slot milling	Face milling	Chamfer milling
					
Plunge milling	Circular milling/ Ramping				

Notes

A

Turning

B

Milling

C

Drilling

D

Technical
Information

E

Index

GM series

For general applications

- For machining of steel to max. 50 HRC and cast iron to heat-resistant alloys.
- Sharp cutting edge with high edge stability. Roughing to finishing with long tool life.
- End mills, ball nose cutters, torus mills, rippers and mini cutters
- Diameter range 0.3–20.0 mm

Application fields for machining of steel

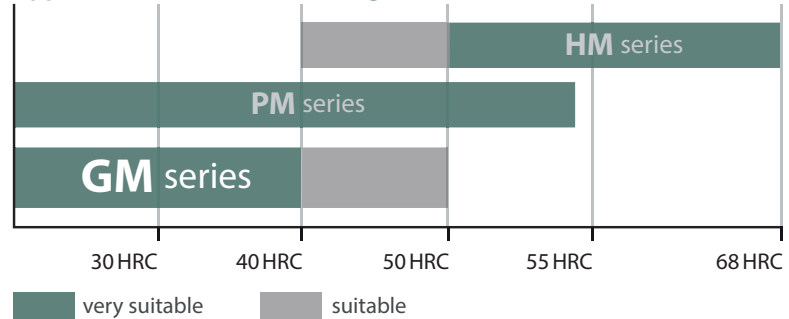

A

End mill

Semi-finishing

Turning

5501R302GM

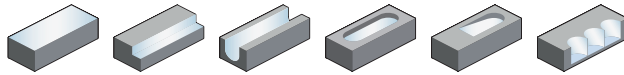

- Type of shank DIN 6535HA
- Centre cutting
- Helix angle 30°

B

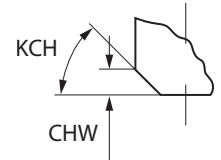
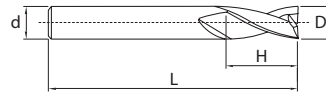

Milling

Article	*	Dimensions [mm]						Teeth	Grade	
		D	d (h6)	H	L	KCH	CHW		KMG303	YK30F
5501R302GM-0300		3	6	4	50	0	0	2	●	○
5501R302GM-0400		4	6	5	54	0	0	2	●	○
5501R302GM-0500		5	6	6	54	0	0	2	●	○
5501R302GM-0600		6	6	7	54	45	0,10	2	●	○
5501R302GM-0800		8	8	9	58	45	0,10	2	●	○
5501R302GM-1000		10	10	11	66	45	0,10	2	●	○
5501R302GM-1200		12	12	12	73	45	0,10	2	●	○
5501R302GM-1400		14	14	14	75	45	0,15	2	●	○
5501R302GM-1600		16	16	16	82	45	0,15	2	●	○
5501R302GM-1800		18	18	18	84	45	0,15	2	●	○
5501R302GM-2000		20	20	20	92	45	0,15	2	●	○

- Ex stock ○ On demand
- * With internal cooling

C

Drilling

Application field

P	M	K	N	S	H
✓	✓	✓			

- ✓ Very suitable
- ✓ Suitable

D

Technical Information

E

Index

System code > B258

Cutting data > B422

Nonstandard order > B461

End mill **Semi-finishing**

5601R302GM

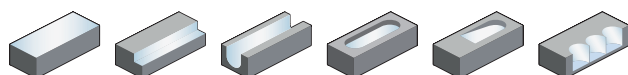

- Type of shank: DIN 6535HB
- Centre cutting
- Helix angle 30°

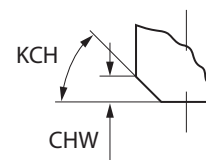
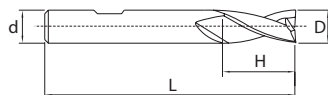

Article	*	Dimensions [mm]						Teeth	Grade	
		D	d (h6)	H	L	KCH	CHW		KMG303	YK30F
5601R302GM-0300		3	6	4	50	0	0	2	●	○
5601R302GM-0400		4	6	5	54	0	0	2	●	○
5601R302GM-0500		5	6	6	54	0	0	2	●	○
5601R302GM-0600		6	6	7	54	45	0,10	2	●	○
5601R302GM-0800		8	8	9	58	45	0,10	2	●	○
5601R302GM-1000		10	10	11	66	45	0,10	2	●	○
5601R302GM-1200		12	12	12	73	45	0,10	2	●	○
5601R302GM-1400		14	14	14	75	45	0,15	2	●	○
5601R302GM-1600		16	16	16	82	45	0,15	2	●	○
5601R302GM-1800		18	18	18	84	45	0,15	2	●	○
5601R302GM-2000		20	20	20	92	45	0,15	2	●	○

● Ex stock ○ On demand

* With internal cooling

Application field					
P	M	K	N	S	H
✓	✓	✓			

✓ Very suitable

✓ Suitable

System code > B258

Cutting data > B422

Nonstandard order > B461



End mill long cutting edge Semi-finishing

5502R302GM

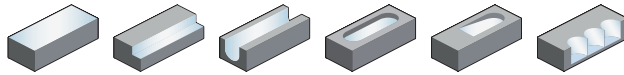

- Type of shank DIN 6535HA
- Centre cutting
- Helix angle 30°

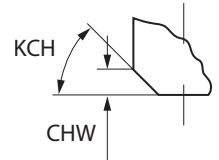
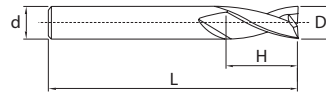

Article	*	Dimensions [mm]						Teeth	Grade	
		D	d (h6)	H	L	KCH	CHW		KMG303	YK30F
5502R302GM-0100		1	3	2	38	0	0	2	●	○
5502R302GM-0150		1.5	3	3	38	0	0	2	●	○
5502R302GM-0200		2	6	6	57	0	0	2	●	○
5502R302GM-0250		2.5	6	7	57	0	0	2	●	○
5502R302GM-0280		2.8	6	7	57	0	0	2	●	○
5502R302GM-0300		3	6	7	57	0	0	2	●	○
5502R302GM-0350		3.5	6	7	57	0	0	2	●	○
5502R302GM-0380		3.8	6	8	57	0	0	2	●	○
5502R302GM-0400		4	6	8	57	0	0	2	●	○
5502R302GM-0450		4.5	6	8	57	0	0	2	●	○
5502R302GM-0480		4.8	6	8	57	0	0	2	●	○
5502R302GM-0500		5	6	10	57	0	0	2	●	○
5502R302GM-0550		5.5	6	10	57	0	0	2	●	○
5502R302GM-0575		5.75	6	10	57	0	0	2	●	○
5502R302GM-0600		6	6	10	57	45	0,10	2	●	○
5502R302GM-0675		6.75	8	13	63	45	0,10	2	○	○
5502R302GM-0700		7	8	13	63	45	0,10	2	●	○
5502R302GM-0750		7.5	8	16	63	45	0,10	2	●	○
5502R302GM-0775		7.75	8	16	63	45	0,10	2	●	○
5502R302GM-0800		8	8	16	63	45	0,10	2	●	○
5502R302GM-0870		8.7	10	16	72	45	0,10	2	●	○
5502R302GM-0900		9	10	16	72	45	0,10	2	●	○
5502R302GM-0950		9.5	10	16	72	45	0,10	2	○	○
5502R302GM-1000		10	10	19	72	45	0,10	2	●	○
5502R302GM-1100		11	12	22	83	45	0,10	2	●	○
5502R302GM-1170		11.7	12	22	83	45	0,10	2	●	○
5502R302GM-1200		12	12	22	83	45	0,10	2	●	○
5502R302GM-1370		13.7	14	22	83	45	0,10	2	●	○
5502R302GM-1400		14	14	22	83	45	0,15	2	●	○
5502R302GM-1500		15	16	26	92	45	0,15	2	●	○
5502R302GM-1570		15.7	16	26	92	45	0,15	2	●	○
5502R302GM-1600		16	16	26	92	45	0,15	2	●	○
5502R302GM-1700		17	18	26	92	45	0,15	2	○	○
5502R302GM-1800		18	18	26	92	45	0,15	2	●	○

● Ex stock ○ On demand

* With internal cooling

Application field

P	M	K	N	S	H
✓	✓	✓			

✓ Very suitable

✓ Suitable

System code > B258

Cutting data > B422

Nonstandard order > B461

End mill long cutting edge **Semi-finishing**

5502R302GM

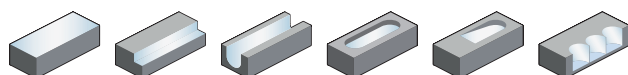

- Type of shank DIN 6535HA
- Centre cutting
- Helix angle 30°

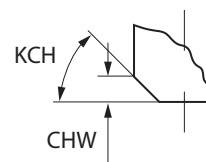
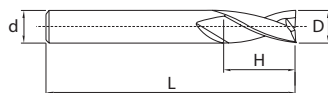

Article	*	Dimensions [mm]					Teeth	Grade		
		D	d (h6)	H	L	KCH		CHW	KMG303	YK30F
5502R302GM-2000		20	20	32	104	45	0,15	2	●	○

- Ex stock ○ On demand
- * With internal cooling

Application field					
P	M	K	N	S	H
✓	✓	✓			

- ✓ Very suitable
- ✓ Suitable

A

Turning

B

Milling

C

Drilling

D

Technical Information

E

Index

System code > B258

Cutting data > B422

Nonstandard order > B461



End mill long cutting edge Semi-finishing

5602R302GM

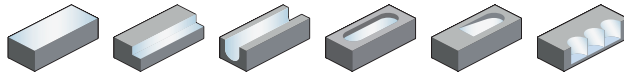

- Type of shank: DIN 6535HB
- Centre cutting
- Helix angle 30°

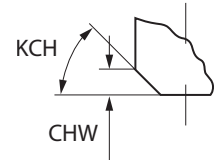
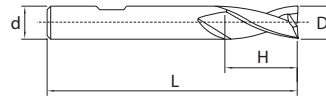

Article	*	Dimensions [mm]						Teeth	Grade	
		D	d (h6)	H	L	KCH	CHW		KMG303	YK30F
5602R302GM-0200		2	6	6	57	0	0	2	●	○
5602R302GM-0250		2.5	6	7	57	0	0	2	●	○
5602R302GM-0280		2.8	6	7	57	0	0	2	●	
5602R302GM-0300		3	6	7	57	0	0	2	●	
5602R302GM-0350		3.5	6	7	57	0	0	2	●	○
5602R302GM-0380		3.8	6	8	57	0	0	2	●	
5602R302GM-0400		4	6	8	57	0	0	2	●	
5602R302GM-0450		4.5	6	8	57	0	0	2	●	○
5602R302GM-0480		4.8	6	8	57	0	0	2	●	
5602R302GM-0500		5	6	10	57	0	0	2	●	
5602R302GM-0550		5.5	6	10	57	0	0	2	●	
5602R302GM-0575		5.75	6	10	57	0	0	2	●	
5602R302GM-0600		6	6	10	57	45	0,10	2	●	
5602R302GM-0700		7	8	13	63	45	0,10	2	●	
5602R302GM-0750		7.5	8	16	63	45	0,10	2	●	○
5602R302GM-0775		7.75	8	16	63	45	0,10	2	●	
5602R302GM-0800		8	8	16	63	45	0,10	2	●	○
5602R302GM-0870		8.7	10	16	72	45	0,10	2	●	
5602R302GM-0900		9	10	16	72	45	0,10	2	●	
5602R302GM-1000		10	10	19	72	45	0,10	2	●	
5602R302GM-1170		11.7	12	22	83	45	0,10	2	●	
5602R302GM-1200		12	12	22	83	45	0,10	2	●	
5602R302GM-1370		13.7	14	22	83	45	0,10	2	●	
5602R302GM-1400		14	14	22	83	45	0,15	2	●	
5602R302GM-1570		15.7	16	26	92	45	0,15	2	●	
5602R302GM-1600		16	16	26	92	45	0,15	2	●	
5602R302GM-1800		18	18	26	92	45	0,15	2	●	
5602R302GM-2000		20	20	32	104	45	0,15	2	●	

● Ex stock ○ On demand

* With internal cooling

Application field

P	M	K	N	S	H
✓	✓	✓			

✓ Very suitable

✓ Suitable

System code > B258

Cutting data > B422

Nonstandard order > B461

End mill **Semi-finishing**

GM-2E

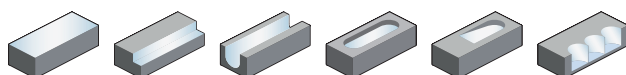

- Factory standard
- Centre cutting
- Helix angle 35°

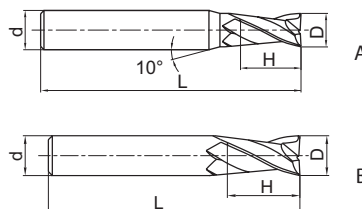

Article	*	Dimensions [mm]				Teeth	Geometry	Grade
		D	d (h6)	H	L			KMG303
GM-2E-D1.0S		1	4	3	50	2	A	●
GM-2E-D1.5S		1.5	4	4	50	2	A	●
GM-2E-D2.0S		2	4	6	50	2	A	●
GM-2E-D2.5S		2.5	4	8	50	2	A	●
GM-2E-D3.0S		3	4	8	50	2	A	●
GM-2E-D4.0S		4	4	11	50	2	B	●
GM-2E-D1.0		1	6	3	50	2	A	●
GM-2E-D1.5		1.5	6	4	50	2	A	●
GM-2E-D2.0		2	6	6	50	2	A	●
GM-2E-D2.5		2.5	6	8	50	2	A	●
GM-2E-D3.0		3	6	8	50	2	A	●
GM-2E-D3.5		3.5	6	10	50	2	A	●
GM-2E-D4.0		4	6	11	50	2	A	●
GM-2E-D4.5		4.5	6	11	50	2	A	●
GM-2E-D5.0		5	6	13	50	2	A	●
GM-2E-D5.5		5.5	6	16	50	2	A	●
GM-2E-D6.0		6	6	16	50	2	B	●
GM-2E-D7.0		7	8	20	60	2	A	●
GM-2E-D8.0		8	8	20	60	2	B	●
GM-2E-D9.0		9	10	22	75	2	A	●
GM-2E-D10.0		10	10	25	75	2	B	●
GM-2E-D11.0		11	12	26	75	2	A	●
GM-2E-D12.0		12	12	30	75	2	B	●
GM-2E-D14.0		14	14	32	75	2	B	●
GM-2E-D16.0		16	16	45	100	2	B	●
GM-2E-D18.0		18	18	45	100	2	B	●
GM-2E-D20.0		20	20	45	100	2	B	●

- Ex stock ○ On demand
- * With internal cooling

Application field					
P	M	K	N	S	H
✓	✓	✓			

- ✓ Very suitable
- ✓ Suitable

System code > B258 Cutting data > B422 Nonstandard order > B461



A

End mill long cutting edge Semi-finishing

GM-2EL

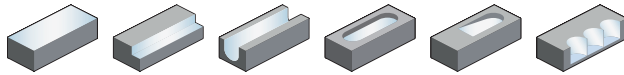

- Factory standard
- Centre cutting
- Helix angle 35°

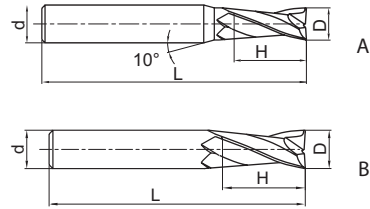

Turning

B

Milling

Article	*	Dimensions [mm]				Teeth	Geometry	Grade
		D	d (h6)	H	L			KMG303
GM-2EL-D3.0		3	6	12	75	2	A	●
GM-2EL-D4.0		4	6	15	75	2	A	●
GM-2EL-D5.0		5	6	20	75	2	A	●
GM-2EL-D6.0		6	6	20	75	2	B	●
GM-2EL-D8.0		8	8	25	100	2	B	●
GM-2EL-D10.0		10	10	30	100	2	B	●
GM-2EL-D12.0		12	12	35	100	2	B	●
GM-2EL-D14.0		14	14	40	100	2	B	●
GM-2EL-D16.0		16	16	50	150	2	B	●
GM-2EL-D20.0		20	20	55	150	2	B	●

- Ex stock ○ On demand
- * With internal cooling

C

Drilling

Application field

P	M	K	N	S	H
✓	✓	✓			

- ✓ Very suitable
- ✓ Suitable

D

Technical Information

E

Index

System code > B258

Cutting data > B422

Nonstandard order > B461

End mill extra long cutting edge **Semi-finishing**

GM-2EX

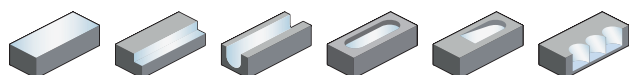

- Factory standard
- Centre cutting
- Helix angle 35°

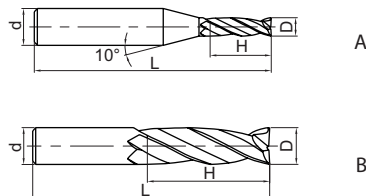

Article	*	Dimensions [mm]				Teeth	Geometry	Grade
		D	d (h6)	H	L			KMG303
GM-2EX-D3.0		3	6	20	75	2	A	●
GM-2EX-D4.0		4	6	25	75	2	A	●
GM-2EX-D5.0		5	6	30	75	2	A	●
GM-2EX-D6.0		6	6	30	75	2	B	●
GM-2EX-D8.0		8	8	40	100	2	B	●
GM-2EX-D10.0		10	10	50	110	2	B	○
GM-2EX-D12.0		12	12	50	110	2	B	○
GM-2EX-D16.0		16	16	70	150	2	B	○
GM-2EX-D20.0		20	20	75	150	2	B	○

● Ex stock ○ On demand

* With internal cooling

Application field					
P	M	K	N	S	H
✓	✓	✓			

✓ Very suitable

✓ Suitable

System code > B258

Cutting data > B422

Nonstandard order > B461



A

End mill short cutting edge Semi-finishing

GM-2EFP

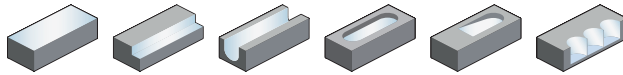

- Factory standard
- Centre cutting
- Helix angle 35°

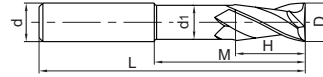

Turning

B

Article	*	Dimensions [mm]						Teeth	Grade
		D	d (h6)	d ₁	H	M	L		KMG303
GM-2EFP-D6.0		6	6	5.8	9	30	30	2	●
GM-2EFP-D8.0		8	8	7.8	12	40	40	2	●
GM-2EFP-D10.0		10	10	9.6	15	50	50	2	●
GM-2EFP-D12.0		12	12	11.5	18	50	50	2	●
GM-2EFP-D16.0		16	16	15.5	24	50	50	2	●

● Ex stock ○ On demand

* With internal cooling

Milling

C

Application field

P	M	K	N	S	H
✓	✓	✓			

✓ Very suitable

✓ Suitable

Drilling

D

Technical Information

E

Index

System code > B258

Cutting data > B422

Nonstandard order > B461

End mill **Semi-finishing**

GM-2F

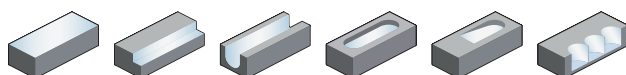

- Factory standard
- Centre cutting
- Helix angle 35°

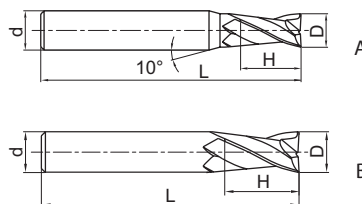

Article	*	Dimensions [mm]				Teeth	Geometry	Grade
		D	d (h6)	H	L			KMG303
GM-2F-D1.0S		1	4	3	50	2	A	○
GM-2F-D1.5S		1.5	4	4	50	2	A	○
GM-2F-D2.0S		2	4	6	50	2	A	○
GM-2F-D2.5S		2.5	4	8	50	2	A	○
GM-2F-D3.0S		3	4	8	50	2	A	○
GM-2F-D4.0S		4	4	11	50	2	B	○
GM-2F-D1.0		1	6	3	50	2	A	○
GM-2F-D1.5		1.5	6	4	50	2	A	○
GM-2F-D2.0		2	6	6	50	2	A	○
GM-2F-D2.5		2.5	6	8	50	2	A	○
GM-2F-D3.0		3	6	8	50	2	A	●
GM-2F-D3.5		3.5	6	10	50	2	A	○
GM-2F-D4.0		4	6	11	50	2	A	●
GM-2F-D4.5		4.5	6	11	50	2	A	○
GM-2F-D5.0		5	6	13	50	2	A	●
GM-2F-D5.5		5.5	6	16	50	2	A	○
GM-2F-D6.0		6	6	16	50	2	B	●
GM-2F-D7.0		7	8	20	60	2	A	○
GM-2F-D8.0		8	8	20	60	2	B	●
GM-2F-D9.0		9	10	22	75	2	A	○
GM-2F-D10.0		10	10	25	75	2	B	○
GM-2F-D11.0		11	12	26	75	2	A	○
GM-2F-D12.0		12	12	30	75	2	B	●
GM-2F-D14.0		14	14	32	75	2	B	○
GM-2F-D16.0		16	16	45	100	2	B	○
GM-2F-D18.0		18	18	45	100	2	B	○
GM-2F-D20.0		20	20	45	100	2	B	○

- Ex stock ○ On demand
- * With internal cooling

Application field					
P	M	K	N	S	H
✓	✓	✓			

- ✓ Very suitable
- ✓ Suitable

System code > B258 Cutting data > B422 Nonstandard order > B461



A
Turning
B
Milling
C
Drilling
D
Technical Information
E
Index

A

End mill long cutting edge Semi-finishing

GM-2FL

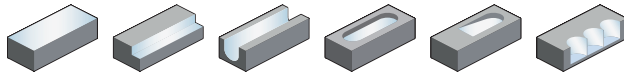

- Factory standard
- Centre cutting
- Helix angle 35°

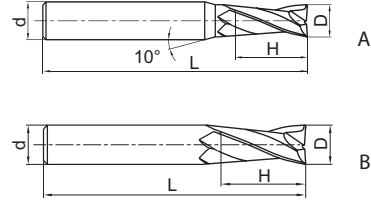

Turning

B

Article	*	Dimensions [mm]				Teeth	Geometry	Grade
		D	d (h6)	H	L			KMG303
GM-2FL-D3.0		3	6	12	75	2	A	○
GM-2FL-D4.0		4	6	15	75	2	A	○
GM-2FL-D5.0		5	6	20	75	2	A	○
GM-2FL-D6.0		6	6	20	75	2	B	○
GM-2FL-D8.0		8	8	25	100	2	B	○
GM-2FL-D10.0		10	10	30	100	2	B	○
GM-2FL-D12.0		12	12	35	100	2	B	○
GM-2FL-D14.0		14	14	40	100	2	B	○
GM-2FL-D16.0		16	16	50	150	2	B	○
GM-2FL-D20.0		20	20	55	150	2	B	○

- Ex stock ○ On demand
- * With internal cooling

Milling

C

Application field

P	M	K	N	S	H
✓	✓	✓			

- ✓ Very suitable
- ✓ Suitable

Drilling

D

Technical Information

E

Index

System code > B258

Cutting data > B422

Nonstandard order > B461

End mill **Semi-finishing**

GM-2EP

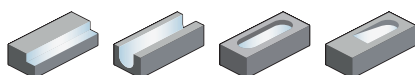

- Factory standard
- Centre cutting
- Helix angle 35°

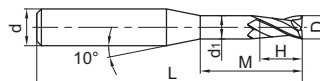

Article	*	Dimensions [mm]						Teeth	Grade
		D	d (h6)	d ₁	H	M	L		KMG303
GM-2EP-D0.5-M04		0.5	4	0.45	0.7	4	50	2	●
GM-2EP-D0.5-M06		0.5	4	0.45	0.7	6	50	2	●
GM-2EP-D0.5-M08		0.5	4	0.45	0.7	8	50	2	●
GM-2EP-D0.8-M04		0.8	4	0.75	1.2	4	50	2	●
GM-2EP-D0.8-M06		0.8	4	0.75	1.2	6	50	2	●
GM-2EP-D0.8-M08		0.8	4	0.75	1.2	8	50	2	●
GM-2EP-D0.8-M10		0.8	4	0.75	1.2	10	50	2	●
GM-2EP-D1.0-M04		1	4	0.95	1.5	4	50	2	●
GM-2EP-D1.0-M06		1	4	0.95	1.5	6	50	2	●
GM-2EP-D1.0-M08		1	4	0.95	1.5	8	50	2	●
GM-2EP-D1.0-M10		1	4	0.95	1.5	10	50	2	●
GM-2EP-D1.0-M12		1	4	0.95	1.5	12	50	2	●
GM-2EP-D1.0-M14		1	4	0.95	1.5	14	50	2	●
GM-2EP-D1.2-M06		1.2	4	1.15	1.8	6	50	2	●
GM-2EP-D1.2-M08		1.2	4	1.15	1.8	8	50	2	●
GM-2EP-D1.2-M10		1.2	4	1.15	1.8	10	50	2	●
GM-2EP-D1.2-M12		1.2	4	1.15	1.8	12	50	2	○
GM-2EP-D1.5-M06		1.5	4	1.45	2.3	6	50	2	●
GM-2EP-D1.5-M08		1.5	4	1.45	2.3	8	50	2	●
GM-2EP-D1.5-M10		1.5	4	1.45	2.3	10	50	2	●
GM-2EP-D1.5-M12		1.5	4	1.45	2.3	12	50	2	●
GM-2EP-D1.5-M14		1.5	4	1.45	2.3	14	50	2	●
GM-2EP-D2.0-M06		2	4	1.95	3	6	50	2	●
GM-2EP-D2.0-M08		2	4	1.95	3	8	50	2	●
GM-2EP-D2.0-M10		2	4	1.95	3	10	50	2	●
GM-2EP-D2.0-M12		2	4	1.95	3	12	50	2	●
GM-2EP-D2.0-M14		2	4	1.95	3	14	50	2	●
GM-2EP-D2.0-M16		2	4	1.95	3	16	50	2	●
GM-2EP-D2.5-M08		2.5	4	2.4	3.7	8	50	2	●
GM-2EP-D2.5-M10		2.5	4	2.4	3.7	10	50	2	●
GM-2EP-D2.5-M12		2.5	4	2.4	3.7	12	50	2	●
GM-2EP-D2.5-M14		2.5	4	2.4	3.7	14	50	2	●
GM-2EP-D2.5-M16		2.5	4	2.4	3.7	16	60	2	●
GM-2EP-D2.5-M18		2.5	4	2.4	3.7	18	60	2	●
GM-2EP-D2.5-M20		2.5	4	2.4	3.7	20	60	2	●
GM-2EP-D3.0-M06		3	6	2.85	4.5	6	50	2	●
GM-2EP-D3.0-M08		3	6	2.85	4.5	8	50	2	●

● Ex stock ○ On demand

* With internal cooling

Application field					
P	M	K	N	S	H
✓	✓	✓			

✓ Very suitable

✓ Suitable

System code > B258

Cutting data > B422

Nonstandard order > B461



A

End mill

Semi-finishing

GM-2EP

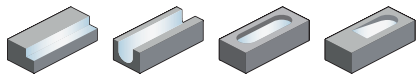

- Factory standard
- Centre cutting
- Helix angle 35°

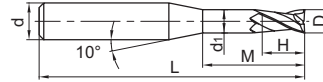

Turning

B

Article	*	Dimensions [mm]						Teeth	Grade
		D	d (h6)	d ₁	H	M	L		KMG303
GM-2EP-D3.0-M10		3	6	2.85	4.5	10	50	2	●
GM-2EP-D3.0-M12		3	6	2.85	4.5	12	50	2	●
GM-2EP-D3.0-M14		3	6	2.85	4.5	14	60	2	●
GM-2EP-D3.0-M16		3	6	2.85	4.5	16	60	2	●
GM-2EP-D3.0-M18		3	6	2.85	4.5	18	60	2	●
GM-2EP-D3.0-M20		3	6	2.85	4.5	20	60	2	●
GM-2EP-D4.0-M12		4	6	3.85	6	12	50	2	●
GM-2EP-D4.0-M14		4	6	3.85	6	14	60	2	●
GM-2EP-D4.0-M16		4	6	3.85	6	16	60	2	●
GM-2EP-D4.0-M20		4	6	3.85	6	20	60	2	●
GM-2EP-D4.0-M25		4	6	3.85	6	25	60	2	●
GM-2EP-D5.0-M16		5	6	4.85	7.5	16	60	2	●
GM-2EP-D5.0-M25		5	6	4.85	7.5	25	70	2	●

● Ex stock ○ On demand

* With internal cooling

Milling

C

Application field

P	M	K	N	S	H
✓	✓	✓			

✓ Very suitable

✓ Suitable

Drilling

D

Technical Information

E

Index

System code > B258

Cutting data > B422

Nonstandard order > B461

End mill

Semi-finishing

GM-2ES

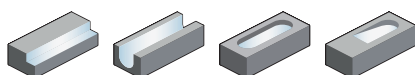

- Factory standard
- Centre cutting
- Helix angle 35°

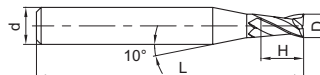

Article	*	Dimensions [mm]				Teeth	Grade
		D	d (h6)	H	L		KMG303
GM-2ES-D0.3		0.3	4	0.6	50	2	●
GM-2ES-D0.4		0.4	4	0.8	50	2	●
GM-2ES-D0.5		0.5	4	1	50	2	●
GM-2ES-D0.6		0.6	4	1.2	50	2	●
GM-2ES-D0.7		0.7	4	1.4	50	2	●
GM-2ES-D0.8		0.8	4	1.6	50	2	●
GM-2ES-D0.9		0.9	4	1.8	50	2	●
GM-2ES-D1.0		1	4	2	50	2	●
GM-2ES-D1.1		1.1	4	2	50	2	●
GM-2ES-D1.2		1.2	4	2.5	50	2	●
GM-2ES-D1.3		1.3	4	2.5	50	2	●
GM-2ES-D1.4		1.4	4	3	50	2	●
GM-2ES-D1.5		1.5	4	3	50	2	●
GM-2ES-D1.6		1.6	4	3.5	50	2	●
GM-2ES-D1.7		1.7	4	3.5	50	2	●
GM-2ES-D1.8		1.8	4	4	50	2	●
GM-2ES-D1.9		1.9	4	4	50	2	●
GM-2ES-D2.0		2	4	4	50	2	●
GM-2ES-D2.1		2.1	4	4	50	2	●
GM-2ES-D2.2		2.2	4	4.5	50	2	●
GM-2ES-D2.3		2.3	4	4.5	50	2	●
GM-2ES-D2.4		2.4	4	5	50	2	●
GM-2ES-D2.5		2.5	4	5	50	2	●
GM-2ES-D2.6		2.6	4	5	50	2	●
GM-2ES-D2.7		2.7	4	5.5	50	2	●
GM-2ES-D2.8		2.8	4	5.5	50	2	●
GM-2ES-D2.9		2.9	4	6	50	2	●
GM-2ES-D3.0		3	4	6	50	2	●

● Ex stock ○ On demand

* With internal cooling

Application field					
P	M	K	N	S	H
✓	✓	✓			

✓ Very suitable

✓ Suitable

System code > B258

Cutting data > B422

Nonstandard order > B461



End mill

Semi-finishing

GM-3E

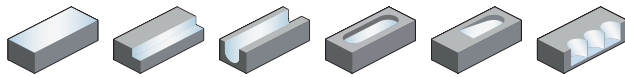

- Factory standard
- Centre cutting
- Helix angle 45°

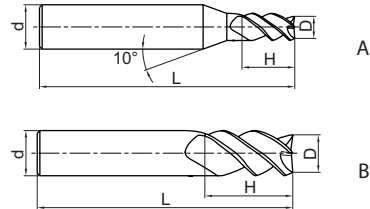

Article	*	Dimensions [mm]				Teeth	Geometry	Grade
		D	d (h6)	H	L			KMG303
GM-3E-D1.0S		1	4	3	50	3	A	○
GM-3E-D1.5S		1.5	4	4	50	3	A	●
GM-3E-D2.0S		2	4	6	50	3	A	●
GM-3E-D2.5S		2.5	4	8	50	3	A	●
GM-3E-D3.0S		3	4	8	50	3	A	●
GM-3E-D4.0S		4	4	11	50	3	B	●
GM-3E-D1.0		1	6	3	50	3	A	○
GM-3E-D1.5		1.5	6	4	50	3	A	●
GM-3E-D2.0		2	6	6	50	3	A	●
GM-3E-D2.5		2.5	6	8	50	3	A	●
GM-3E-D3.0		3	6	8	50	3	A	●
GM-3E-D3.5		3.5	6	10	50	3	A	●
GM-3E-D4.0		4	6	11	50	3	A	●
GM-3E-D4.5		4.5	6	11	50	3	A	●
GM-3E-D5.0		5	6	13	50	3	A	●
GM-3E-D5.5		5.5	6	16	50	3	A	●
GM-3E-D6.0		6	6	16	50	3	B	●
GM-3E-D7.0		7	8	20	60	3	A	●
GM-3E-D8.0		8	8	20	60	3	B	●
GM-3E-D9.0		9	10	22	75	3	A	○
GM-3E-D10.0		10	10	25	75	3	B	●
GM-3E-D11.0		11	12	26	75	3	A	○
GM-3E-D12.0		12	12	30	75	3	B	○
GM-3E-D14.0		14	14	32	75	3	B	○
GM-3E-D16.0		16	16	45	100	3	B	●
GM-3E-D18.0		18	18	45	100	3	B	●
GM-3E-D20.0		20	20	45	100	3	B	●

● Ex stock ○ On demand

* With internal cooling

Application field

P	M	K	N	S	H
✓	✓	✓			

✓ Very suitable

✓ Suitable

System code > B258

Cutting data > B422

Nonstandard order > B461

End mill long cutting edge **Semi-finishing**

GM-3EL

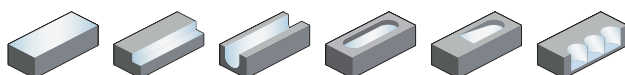

- Factory standard
- Centre cutting
- Helix angle 45°

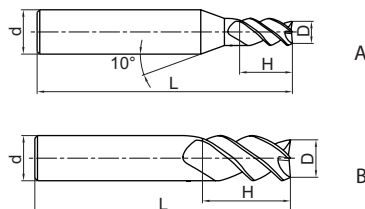

Article	*	Dimensions [mm]				Teeth	Geometry	Grade
		D	d (h6)	H	L			KMG303
GM-3EL-D3.0		3	6	12	75	3	A	●
GM-3EL-D4.0		4	6	15	75	3	A	●
GM-3EL-D5.0		5	6	20	75	3	A	●
GM-3EL-D6.0		6	6	20	75	3	B	●
GM-3EL-D8.0		8	8	25	100	3	B	●
GM-3EL-D10.0		10	10	30	100	3	B	●
GM-3EL-D12.0		12	12	35	100	3	B	●
GM-3EL-D14.0		14	14	40	100	3	B	●
GM-3EL-D16.0		16	16	50	150	3	B	●
GM-3EL-D20.0		20	20	55	150	3	B	●

● Ex stock ○ On demand

* With internal cooling

Application field					
P	M	K	N	S	H
✓	✓	✓			

✓ Very suitable

✓ Suitable

System code > B258

Cutting data > B422

Nonstandard order > B461



A

End mill

Semi-finishing

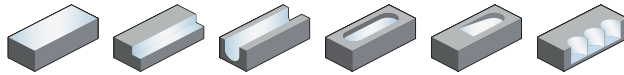

5501R303GM

- Type of shank DIN 6535HA
- Centre cutting
- Helix angle 30°

Turning

B

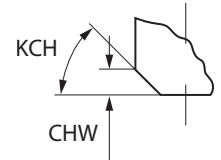
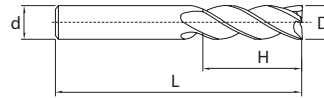

Milling

Article	*	Dimensions [mm]						Teeth	Grade	
		D	d (h6)	H	L	KCH	CHW		KMG303	YK30F
5501R303GM-0300		3	6	4	50	0	0	3	●	○
5501R303GM-0400		4	6	5	54	0	0	3	●	○
5501R303GM-0500		5	6	6	54	0	0	3	●	○
5501R303GM-0600		6	6	7	54	45	0,10	3	●	○
5501R303GM-0800		8	8	9	58	45	0,10	3	●	○
5501R303GM-1000		10	10	11	66	45	0,10	3	●	○
5501R303GM-1200		12	12	12	73	45	0,10	3	●	○
5501R303GM-1400		14	14	14	75	45	0,15	3	●	○
5501R303GM-1600		16	16	16	82	45	0,15	3	●	○
5501R303GM-1800		18	18	18	84	45	0,15	3	●	○
5501R303GM-2000		20	20	20	92	45	0,15	3	●	○

- Ex stock ○ On demand
- * With internal cooling

C

Drilling

Application field

P	M	K	N	S	H
✓	✓	✓			

- ✓ Very suitable
- ✓ Suitable

D

Technical Information

E

Index

System code > B258

Cutting data > B422

Nonstandard order > B461

End mill **Semi-finishing**

5601R303GM

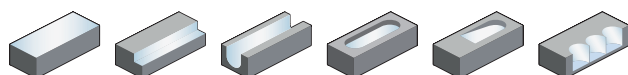

- Type of shank: DIN 6535HB
- Centre cutting
- Helix angle 30°

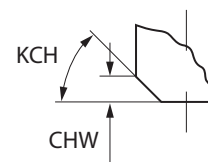
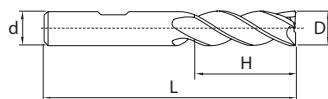

Article	*	Dimensions [mm]						Teeth	Grade	
		D	d (h6)	H	L	KCH	CHW		KMG303	YK30F
5601R303GM-0300		3	6	4	50	0	0	3	●	○
5601R303GM-0400		4	6	5	54	0	0	3	●	○
5601R303GM-0500		5	6	6	54	0	0	3	●	○
5601R303GM-0600		6	6	7	54	45	0,10	3	●	○
5601R303GM-0800		8	8	9	58	45	0,10	3	●	○
5601R303GM-1000		10	10	11	66	45	0,10	3	●	○
5601R303GM-1200		12	12	12	73	45	0,10	3	●	○
5601R303GM-1400		14	14	14	75	45	0,15	3	●	○
5601R303GM-1600		16	16	16	82	45	0,15	3	●	○
5601R303GM-1800		18	18	18	84	45	0,15	3	●	○
5601R303GM-2000		20	20	20	92	45	0,15	3	●	○

● Ex stock ○ On demand

* With internal cooling

Application field					
P	M	K	N	S	H
✓	✓	✓			

✓ Very suitable

✓ Suitable

System code > B258

Cutting data > B422

Nonstandard order > B461



A

End mill long cutting edge Semi-finishing

5502R303GM

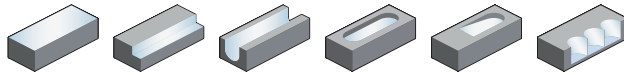

- Type of shank DIN 6535HA
- Centre cutting
- Helix angle 30°

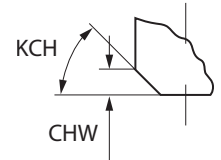
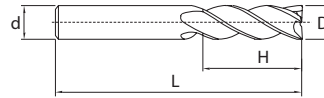

Turning

B

Article	*	Dimensions [mm]						Teeth	Grade	
		D	d (h6)	H	L	KCH	CHW		KMG303	YK30F
5502R303GM-0300		3	6	7	57	0	0	3	●	○
5502R303GM-0400		4	6	8	57	0	0	3	●	○
5502R303GM-0500		5	6	10	57	0	0	3	●	○
5502R303GM-0600		6	6	10	57	45	0,10	3	●	○
5502R303GM-0800		8	8	16	63	45	0,10	3	●	○
5502R303GM-1000		10	10	19	72	45	0,10	3	●	○
5502R303GM-1200		12	12	22	83	45	0,10	3	●	○
5502R303GM-1400		14	14	22	83	45	0,15	3	●	○
5502R303GM-1600		16	16	26	92	45	0,15	3	●	○
5502R303GM-1800		18	18	26	92	45	0,15	3	●	○
5502R303GM-2000		20	20	32	104	45	0,15	3	●	○

- Ex stock ○ On demand
- * With internal cooling

Milling

C

Application field

P	M	K	N	S	H
✓	✓	✓			

- ✓ Very suitable
- ✓ Suitable

Drilling

D

Technical Information

E

Index

System code > B258

Cutting data > B422

Nonstandard order > B461

End mill long cutting edge **Semi-finishing**

5602R303GM

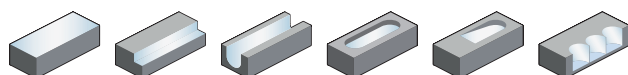

- Type of shank: DIN 6535HB
- Centre cutting
- Helix angle 30°

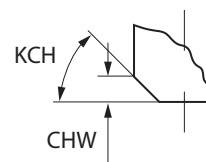
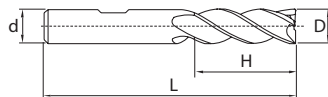

Article	*	Dimensions [mm]					Teeth	Grade	
		D	d (h6)	H	L	KCH		CHW	KMG303
5602R303GM-0300		3	6	7	57	0	0	●	○
5602R303GM-0400		4	6	8	57	0	0	●	○
5602R303GM-0500		5	6	10	57	0	0	●	○
5602R303GM-0600		6	6	10	57	45	0,10	●	○
5602R303GM-0800		8	8	16	63	45	0,10	●	○
5602R303GM-1000		10	10	19	72	45	0,10	●	○
5602R303GM-1200		12	12	22	83	45	0,10	●	○
5602R303GM-1400		14	14	22	83	45	0,15	●	○
5602R303GM-1600		16	16	26	92	45	0,15	●	○
5602R303GM-1800		18	18	26	92	45	0,15	●	○
5602R303GM-2000		20	20	32	104	45	0,15	●	○

● Ex stock ○ On demand

* With internal cooling

Application field					
P	M	K	N	S	H
✓	✓	✓			

✓ Very suitable

✓ Suitable

System code > B258

Cutting data > B422

Nonstandard order > B461



A

End mill long cutting edge Semi-finishing

5502R453GM

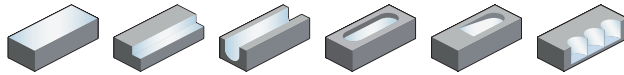

- Type of shank DIN 6535HA
- Centre cutting
- Helix angle 45°

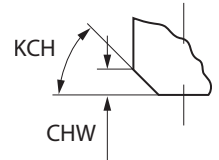
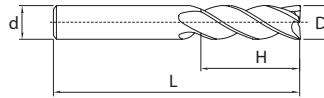

Turning

B

Article	*	Dimensions [mm]						Teeth	Grade
		D	d (h6)	H	L	KCH	CHW		KMG405
5502R453GM-0300		3	6	7	57	0	0	3	●
5502R453GM-0400		4	6	8	57	0	0	3	●
5502R453GM-0500		5	6	10	57	0	0	3	●
5502R453GM-0600		6	6	10	57	45	0,10	3	●
5502R453GM-0800		8	8	16	63	45	0,10	3	●
5502R453GM-1000		10	10	19	72	45	0,10	3	●
5502R453GM-1200		12	12	22	83	45	0,10	3	●
5502R453GM-1400		14	14	22	83	45	0,15	3	●
5502R453GM-1600		16	16	26	92	45	0,15	3	●
5502R453GM-1800		18	18	26	92	45	0,15	3	●
5502R453GM-2000		20	20	32	104	45	0,15	3	●

- Ex stock ○ On demand
- * With internal cooling

Milling

C

Application field

P	M	K	N	S	H
✓	✓	✓			

- ✓ Very suitable
- ✓ Suitable

Drilling

D

Technical Information

E

Index

System code > B258

Cutting data > B422

Nonstandard order > B461

End mill long cutting edge **Semi-finishing**

5602R453GM

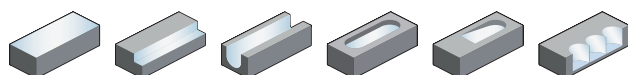

- Type of shank: DIN 6535HB
- Centre cutting
- Helix angle 45°

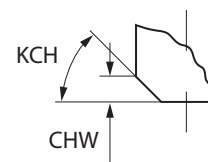
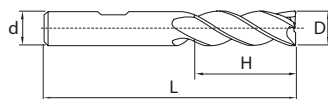

Article	*	Dimensions [mm]						Teeth	Grade	
		D	d (h6)	H	L	KCH	CHW		KMG303	KMG405
5602R453GM-0300		3	6	7	57	0	0	3	●	●
5602R453GM-0400		4	6	8	57	0	0	3	●	●
5602R453GM-0500		5	6	10	57	0	0	3	●	●
5602R453GM-0600		6	6	10	57	45	0,10	3	●	●
5602R453GM-0800		8	8	16	63	45	0,10	3	●	●
5602R453GM-1000		10	10	19	72	45	0,10	3	●	●
5602R453GM-1200		12	12	22	83	45	0,10	3	●	●
5602R453GM-1400		14	14	22	83	45	0,15	3	●	●
5602R453GM-1600		16	16	26	92	45	0,15	3	●	●
5602R453GM-1800		18	18	26	92	45	0,15	3	●	●
5602R453GM-2000		20	20	32	104	45	0,15	3	●	●

● Ex stock ○ On demand

* With internal cooling

Application field					
P	M	K	N	S	H
✓	✓	✓			

✓ Very suitable

✓ Suitable

System code > B258

Cutting data > B422

Nonstandard order > B461



A

End mill

Semi-finishing

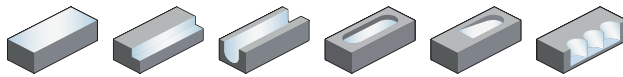

GM-4F-G

- Factory standard
- Centre cutting
- Helix angle 30°

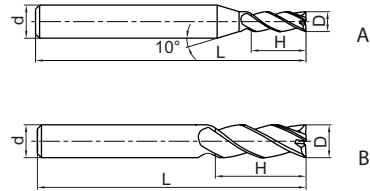

Turning

B

Milling

C

Drilling

D

Technical Information

Article	*	Dimensions [mm]				Teeth	Geometry	Grade
		D	d (h6)	H	L			KMG303
GM-4F-D1.0S-G		1	4	3	50	4	A	○
GM-4F-D1.5S-G		1.5	4	4	50	4	A	○
GM-4F-D2.0S-G		2	4	6	50	4	A	○
GM-4F-D2.5S-G		2.5	4	8	50	4	A	○
GM-4F-D3.0S-G		3	4	8	50	4	A	○
GM-4F-D4.0S-G		4	4	11	50	4	B	○
GM-4F-D1.0-G		1	6	3	50	4	A	○
GM-4F-D1.5-G		1.5	6	4	50	4	A	○
GM-4F-D2.0-G		2	6	6	50	4	A	○
GM-4F-D2.5-G		2.5	6	8	50	4	A	○
GM-4F-D3.0-G		3	6	8	50	4	A	○
GM-4F-D3.5-G		3.5	6	10	50	4	A	○
GM-4F-D4.0-G		4	6	11	50	4	A	○
GM-4F-D4.5-G		4.5	6	11	50	4	A	○
GM-4F-D5.0-G		5	6	13	50	4	A	○
GM-4F-D5.5-G		5.5	6	16	50	4	A	○
GM-4F-D6.0-G		6	6	16	50	4	B	○
GM-4F-D7.0-G		7	8	20	60	4	A	○
GM-4F-D8.0-G		8	8	20	60	4	B	○
GM-4F-D9.0-G		9	10	22	75	4	A	○
GM-4F-D10.0-G		10	10	25	75	4	B	○
GM-4F-D11.0-G		11	12	26	75	4	A	○
GM-4F-D12.0-G		12	12	30	75	4	B	○
GM-4F-D14.0-G		14	14	32	75	4	B	○
GM-4F-D16.0-G		16	16	45	100	4	B	○
GM-4F-D18.0-G		18	18	45	100	4	B	○
GM-4F-D20.0-G		20	20	45	100	4	B	○

● Ex stock ○ On demand

* With internal cooling

E

Application field

P	M	K	N	S	H
✓	✓	✓			

✓ Very suitable

✓ Suitable

Index

System code > B258

Cutting data > B422

Nonstandard order > B461

End mill long cutting edge

Semi-finishing

GM-4EL-G

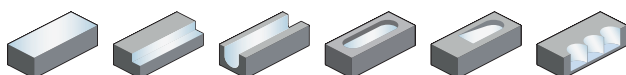

- Factory standard
- Centre cutting
- Helix angle 30°

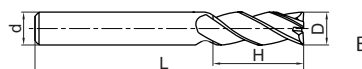
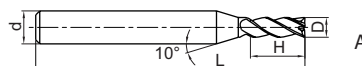

Article	*	Dimensions [mm]				Teeth	Geometry	Grade
		D	d (h6)	H	L			KMG303
GM-4EL-D3.0-G		3	6	12	75	4	A	○
GM-4EL-D4.0-G		4	6	15	75	4	A	○
GM-4EL-D5.0-G		5	6	20	75	4	A	○
GM-4EL-D6.0-G		6	6	20	75	4	B	○
GM-4EL-D8.0-G		8	8	25	100	4	B	○
GM-4EL-D10.0-G		10	10	30	100	4	B	○
GM-4EL-D12.0-G		12	12	35	100	4	B	○
GM-4EL-D14.0-G		14	14	40	100	4	B	○
GM-4EL-D16.0-G		16	16	50	150	4	B	○
GM-4EL-D20.0-G		20	20	55	150	4	B	○

● Ex stock ○ On demand

* With internal cooling

Application field					
P	M	K	N	S	H
✓	✓	✓			

✓ Very suitable

✓ Suitable

System code > B258

Cutting data > B422

Nonstandard order > B461



A

End mill long cutting edge Semi-finishing

GM-4FL-G

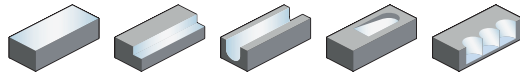

- Factory standard
- Centre cutting
- Helix angle 30°

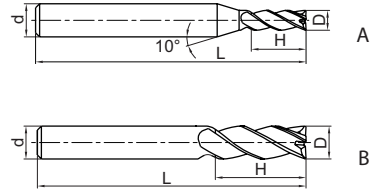

Turning

B

Milling

Article	*	Dimensions [mm]				Teeth	Geometry	Grade
		D	d (h6)	H	L			KMG303
GM-4FL-D3.0-G		3	6	12	75	4	A	○
GM-4FL-D4.0-G		4	6	15	75	4	A	○
GM-4FL-D5.0-G		5	6	20	75	4	A	●
GM-4FL-D6.0-G		6	6	20	75	4	B	●
GM-4FL-D8.0-G		8	8	25	100	4	B	●
GM-4FL-D10.0-G		10	10	30	100	4	B	●
GM-4FL-D12.0-G		12	12	35	100	4	B	●
GM-4FL-D14.0-G		14	14	40	100	4	B	○
GM-4FL-D16.0-G		16	16	50	150	4	B	○

● Ex stock ○ On demand

* With internal cooling

C

Drilling

Application field

P	M	K	N	S	H
✓	✓	✓			

✓ Very suitable

✓ Suitable

D

Technical Information

E

Index

System code > B258

Cutting data > B422

Nonstandard order > B461

End mill extra long cutting edge **Semi-finishing**

GM-4EX-G

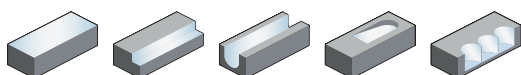

- Factory standard
- Centre cutting
- Helix angle 30°

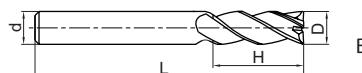
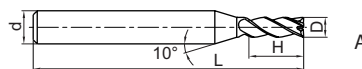

Article	*	Dimensions [mm]				Teeth	Geometry	Grade
		D	d (h6)	H	L			KMG303
GM-4EX-D3.0-G		3	6	20	75	4	A	●
GM-4EX-D4.0-G		4	6	25	75	4	A	●
GM-4EX-D5.0-G		5	6	30	75	4	A	●
GM-4EX-D6.0-G		6	6	30	75	4	B	●
GM-4EX-D8.0-G		8	8	40	100	4	B	●
GM-4EX-D10.0-G		10	10	50	110	4	B	●
GM-4EX-D12.0-G		12	12	50	110	4	B	●
GM-4EX-D16.0-G		16	16	70	150	4	B	●
GM-4EX-D20.0-G		20	20	75	150	4	B	●
GM-4FL-D20.0-G		20	20	55	150	4	B	○

● Ex stock ○ On demand

* With internal cooling

Application field					
P	M	K	N	S	H
✓	✓	✓			

✓ Very suitable

✓ Suitable

System code > B258

Cutting data > B422

Nonstandard order > B461



A

End mill

Semi-finishing

GM-4E

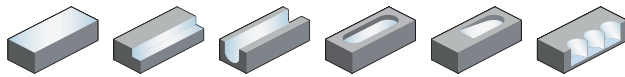

- Factory standard
- Centre cutting
- Helix angle 45°

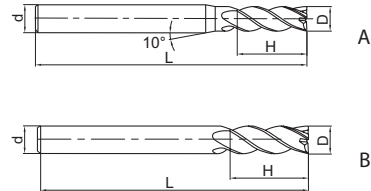

Turning

B

Milling

C

Drilling

D

Technical Information

Article	*	Dimensions [mm]				Teeth	Geometry	Grade
		D	d (h6)	H	L			KMG303
GM-4E-D1.0S		1	4	3	50	4	A	●
GM-4E-D1.5S		1.5	4	4	50	4	A	●
GM-4E-D2.0S		2	4	6	50	4	A	●
GM-4E-D2.5S		2.5	4	8	50	4	A	●
GM-4E-D3.0S		3	4	8	50	4	A	●
GM-4E-D4.0S		4	4	11	50	4	B	●
GM-4E-D1.0		1	6	3	50	4	A	●
GM-4E-D1.5		1.5	6	4	50	4	A	●
GM-4E-D2.0		2	6	6	50	4	A	●
GM-4E-D2.5		2.5	6	8	50	4	A	●
GM-4E-D3.0		3	6	8	50	4	A	●
GM-4E-D3.5		3.5	6	10	50	4	A	●
GM-4E-D4.0		4	6	11	50	4	A	●
GM-4E-D4.5		4.5	6	11	50	4	A	●
GM-4E-D5.0		5	6	13	50	4	A	●
GM-4E-D5.5		5.5	6	16	50	4	A	●
GM-4E-D6.0		6	6	16	50	4	B	●
GM-4E-D7.0		7	8	20	60	4	A	●
GM-4E-D8.0		8	8	20	60	4	B	●
GM-4E-D9.0		9	10	22	75	4	A	●
GM-4E-D10.0		10	10	25	75	4	B	●
GM-4E-D11.0		11	12	26	75	4	A	●
GM-4E-D12.0		12	12	30	75	4	B	●
GM-4E-D14.0		14	14	32	75	4	B	●
GM-4E-D16.0		16	16	45	100	4	B	●
GM-4E-D18.0		18	18	45	100	4	B	●
GM-4E-D20.0		20	20	45	100	4	B	●

● Ex stock ○ On demand

* With internal cooling

E

Index

Application field

P	M	K	N	S	H
✓	✓	✓			

✓ Very suitable

✓ Suitable

System code > B258

Cutting data > B422

Nonstandard order > B461

End mill **Semi-finishing**

GM-4E-G

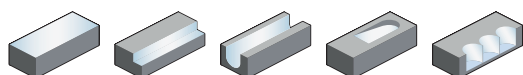

- Factory standard
- Centre cutting
- Helix angle 30°

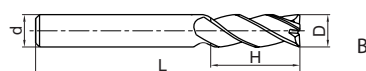
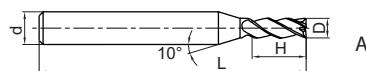

Article	*	Dimensions [mm]				Teeth	Geometry	Grade
		D	d (h6)	H	L			KMG303
GM-4E-D1.0S-G		1	4	3	50	4	A	●
GM-4E-D1.5S-G		1.5	4	4	50	4	A	●
GM-4E-D2.0S-G		2	4	6	50	4	A	●
GM-4E-D2.5S-G		2.5	4	8	50	4	A	●
GM-4E-D3.0S-G		3	4	8	50	4	A	●
GM-4E-D4.0S-G		4	4	11	50	4	B	●
GM-4E-D1.0-G		1	6	3	50	4	A	●
GM-4E-D1.5-G		1.5	6	4	50	4	A	●
GM-4E-D2.0-G		2	6	6	50	4	A	●
GM-4E-D2.5-G		2.5	6	8	50	4	A	●
GM-4E-D3.0-G		3	6	8	50	4	A	●
GM-4E-D3.5-G		3.5	6	10	50	4	A	●
GM-4E-D4.0-G		4	6	11	50	4	A	●
GM-4E-D4.5-G		4.5	6	11	50	4	A	○
GM-4E-D5.0-G		5	6	13	50	4	A	●
GM-4E-D5.5-G		5.5	6	16	50	4	A	●
GM-4E-D6.0-G		6	6	16	50	4	B	●
GM-4E-D7.0-G		7	8	20	60	4	A	●
GM-4E-D8.0-G		8	8	20	60	4	B	●
GM-4E-D9.0-G		9	10	22	75	4	A	●
GM-4E-D10.0-G		10	10	25	75	4	B	●
GM-4E-D11.0-G		11	12	26	75	4	A	●
GM-4E-D12.0-G		12	12	30	75	4	B	●
GM-4E-D14.0-G		14	14	32	75	4	B	●
GM-4E-D16.0-G		16	16	45	100	4	B	●
GM-4E-D18.0-G		18	18	45	100	4	B	●
GM-4E-D20.0-G		20	20	45	100	4	B	●

● Ex stock ○ On demand

* With internal cooling

Application field					
P	M	K	N	S	H
✓	✓	✓			

✓ Very suitable

✓ Suitable

System code > B258

Cutting data > B422

Nonstandard order > B461



A

End mill long cutting edge Semi-finishing

GM-4EL

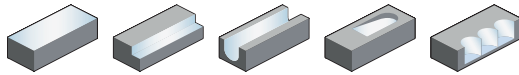

- Factory standard
- Centre cutting
- Helix angle 45°

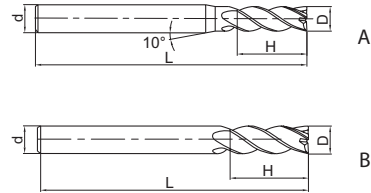

Turning

B

Article	*	Dimensions [mm]				Teeth	Geometry	Grade
		D	d (h6)	H	L			KMG303
GM-4EL-D3.0		3	6	12	75	4	A	●
GM-4EL-D4.0		4	6	15	75	4	A	●
GM-4EL-D5.0		5	6	20	75	4	A	●
GM-4EL-D6.0		6	6	20	75	4	B	●
GM-4EL-D8.0		8	8	25	100	4	B	●
GM-4EL-D10.0		10	10	30	100	4	B	●
GM-4EL-D12.0		12	12	35	100	4	B	●
GM-4EL-D14.0		14	14	40	100	4	B	●
GM-4EL-D16.0		16	16	50	150	4	B	●
GM-4EL-D20.0		20	20	55	150	4	B	●

- Ex stock ○ On demand
- * With internal cooling

Milling

C

Application field

P	M	K	N	S	H
✓	✓	✓			

- ✓ Very suitable
- ✓ Suitable

Drilling

D

System code > B258

Cutting data > B422

Nonstandard order > B461

Technical Information

E

Index

End mill short cutting edge **Semi-finishing**

GM-4EFP

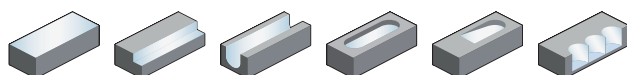

- Factory standard
- Centre cutting
- Helix angle 45°

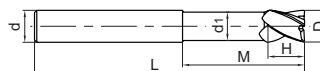

Article	*	Dimensions [mm]						Teeth	Grade
		D	d (h6)	d ₁	H	M	L		KMG303
GM-4EFP-D6.0		6	6	5.8	9	30	75	4	o
GM-4EFP-D8.0		8	8	7.8	12	40	100	4	o
GM-4EFP-D10.0		10	10	9.6	15	50	100	4	o
GM-4EFP-D12.0		12	12	11.5	18	50	100	4	o
GM-4EFP-D16.0		16	16	15.5	24	50	150	4	o
GM-4EFP-D20.0		20	20	19.5	30	60	150	4	o

● Ex stock ○ On demand

* With internal cooling

Application field

P	M	K	N	S	H
✓	✓	✓			

✓ Very suitable

✓ Suitable

System code > B258

Cutting data > B422

Nonstandard order > B461



A

End mill Finishing

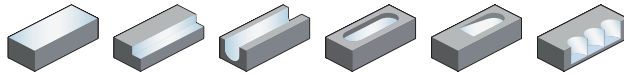

5501R304GF

- Type of shank DIN 6535HA
- Centre cutting
- Helix angle 30°

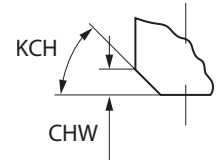
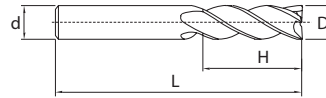

Turning

B

Article	*	Dimensions [mm]						Teeth	Grade	
		D	d (h6)	H	L	KCH	CHW		KMG303	YK30F
5501R304GF-0300		3	6	5	50	0	0	4	●	○
5501R304GF-0400		4	6	8	54	0	0	4	●	○
5501R304GF-0500		5	6	9	54	0	0	4	●	○
5501R304GF-0600		6	6	10	54	45	0,10	4	●	○
5501R304GF-0800		8	8	12	58	45	0,10	4	●	○
5501R304GF-1000		10	10	14	66	45	0,10	4	●	○
5501R304GF-1200		12	12	16	73	45	0,10	4	●	○
5501R304GF-1400		14	14	18	75	45	0,15	4	●	○
5501R304GF-1600		16	16	22	82	45	0,15	4	●	○
5501R304GF-1800		18	18	24	84	45	0,15	4	●	○
5501R304GF-2000		20	20	26	92	45	0,15	4	●	○

- Ex stock ○ On demand
- * With internal cooling

Milling

C

Application field

P	M	K	N	S	H
✓	✓	✓			

- ✓ Very suitable
- ✓ Suitable

Drilling

D

Technical Information

E

Index

System code > B258

Cutting data > B422

Nonstandard order > B461

End mill **Finishing**

5601R304GF

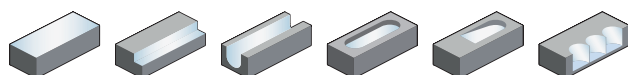

- Type of shank: DIN 6535HB
- Centre cutting
- Helix angle 30°

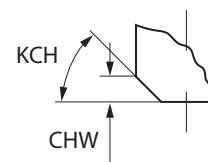
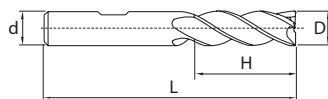

Article	*	Dimensions [mm]						Teeth	Grade	
		D	d (h6)	H	L	KCH	CHW		KMG303	YK30F
5601R304GF-0300		3	6	5	50	0	0	4	●	○
5601R304GF-0400		4	6	8	54	0	0	4	●	○
5601R304GF-0500		5	6	9	54	0	0	4	●	○
5601R304GF-0600		6	6	10	54	45	0,10	4	●	○
5601R304GF-0800		8	8	12	58	45	0,10	4	●	○
5601R304GF-1000		10	10	14	66	45	0,10	4	●	○
5601R304GF-1200		12	12	16	73	45	0,10	4	●	●
5601R304GF-1400		14	14	18	75	45	0,15	4	●	
5601R304GF-1600		16	16	22	82	45	0,15	4	●	○
5601R304GF-1800		18	18	24	84	45	0,15	4	●	○
5601R304GF-2000		20	20	26	92	45	0,15	4	●	○

● Ex stock ○ On demand

* With internal cooling

Application field					
P	M	K	N	S	H
✓	✓	✓			

✓ Very suitable

✓ Suitable

System code > B258

Cutting data > B422

Nonstandard order > B461



A

End mill long cutting edge Finishing

5502R304GF

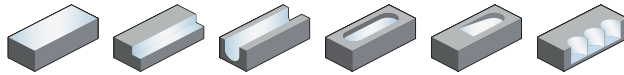

- Type of shank DIN 6535HA
- Centre cutting
- Helix angle 30°

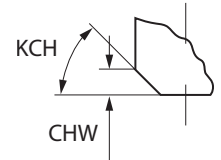
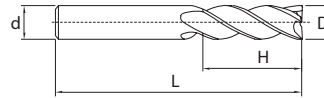

Turning

B

Article	*	Dimensions [mm]						Teeth	Grade	
		D	d (h6)	H	L	KCH	CHW		KMG303	YK30F
5502R304GF-0300		3	6	8	57	0	0	4	●	○
5502R304GF-0400		4	6	11	57	0	0	4	●	○
5502R304GF-0500		5	6	13	57	0	0	4	●	○
5502R304GF-0600		6	6	13	57	45	0,10	4	●	○
5502R304GF-0800		8	8	19	63	45	0,10	4	●	○
5502R304GF-1000		10	10	22	72	45	0,10	4	●	○
5502R304GF-1200		12	12	26	83	45	0,10	4	●	○
5502R304GF-1400		14	14	26	83	45	0,15	4	●	○
5502R304GF-1600		16	16	32	92	45	0,15	4	●	○
5502R304GF-1800		18	18	32	92	45	0,15	4	●	○
5502R304GF-2000		20	20	38	104	45	0,15	4	●	○

- Ex stock ○ On demand
- * With internal cooling

Milling

C

Application field

P	M	K	N	S	H
✓	✓	✓			

- ✓ Very suitable
- ✓ Suitable

Drilling

D

Technical Information

E

Index

System code > B258

Cutting data > B422

Nonstandard order > B461

End mill long cutting edge **Finishing**

5602R304GF

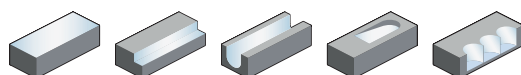

- Type of shank: DIN 6535HB
- Centre cutting
- Helix angle 30°

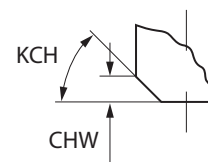
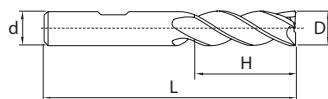

Article	*	Dimensions [mm]						Teeth	Grade	
		D	d (h6)	H	L	KCH	CHW		KMG303	YK30F
5602R304GF-0300		3	6	8	57	0	0	4	●	○
5602R304GF-0400		4	6	11	57	0	0	4	●	○
5602R304GF-0500		5	6	13	57	0	0	4	●	○
5602R304GF-0600		6	6	13	57	45	0,10	4	●	○
5602R304GF-0800		8	8	19	63	45	0,10	4	●	○
5602R304GF-1000		10	10	22	72	45	0,10	4	●	○
5602R304GF-1200		12	12	26	83	45	0,10	4	●	○
5602R304GF-1400		14	14	26	83	45	0,15	4	●	○
5602R304GF-1600		16	16	32	92	45	0,15	4	●	○
5602R304GF-1800		18	18	32	92	45	0,15	4	●	○
5602R304GF-2000		20	20	38	104	45	0,15	4	●	○

● Ex stock ○ On demand

* With internal cooling

Application field					
P	M	K	N	S	H
✓	✓	✓			

✓ Very suitable

✓ Suitable

System code > B258

Cutting data > B422

Nonstandard order > B461



A

End mill long cutting edge Semi-finishing

5508R454GM

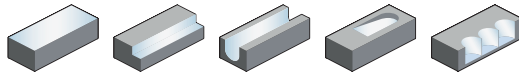

- Type of shank DIN 6535HA
- Centre cutting
- Helix angle 45°

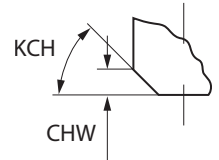
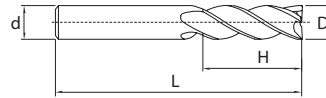

Turning

B

Article	*	Dimensions [mm]						Teeth	Grade	
		D	d (h6)	H	L	KCH	CHW		KMG303	YK30F
5508R454GM-0300		3	3	8	45	0	0	4	●	○
5508R454GM-0400		4	4	11	50	0	0	4	●	○
5508R454GM-0500		5	5	13	50	0	0	4	●	○
5508R454GM-0600		6	6	13	57	45	0,10	4	●	○
5508R454GM-0800		8	8	19	63	45	0,10	4	●	○
5508R454GM-1000		10	10	22	72	45	0,10	4	●	○
5508R454GM-1200		12	12	26	83	45	0,10	4	●	○
5508R454GM-1400		14	14	26	83	45	0,15	4	●	○
5508R454GM-1600		16	16	32	92	45	0,15	4	●	○
5508R454GM-1800		18	18	32	92	45	0,15	4	●	○
5508R454GM-2000		20	20	38	104	45	0,15	4	●	○

- Ex stock ○ On demand
- * With internal cooling

Milling

C

Application field

P	M	K	N	S	H
✓	✓	✓			

- ✓ Very suitable
- ✓ Suitable

Drilling

D

Technical Information

E

Index

System code > B258

Cutting data > B422

Nonstandard order > B461

End mill long cutting edge

Semi-finishing

5602R454GM

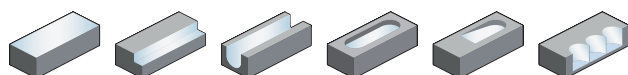

- Type of shank: DIN 6535HB
- Centre cutting
- Helix angle 45°

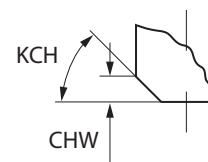
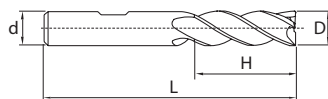

Article	*	Dimensions [mm]						Teeth	Grade
		D	d (h6)	H	L	KCH	CHW		KMG303
5602R454GM-0300		3	6	8	57	0	0	4	●
5602R454GM-0400		4	6	11	57	0	0	4	●
5602R454GM-0500		5	6	13	57	0	0	4	●
5602R454GM-0600		6	6	13	57	45	0,10	4	●
5602R454GM-0800		8	8	19	63	45	0,10	4	●
5602R454GM-1000		10	10	22	72	45	0,10	4	●
5602R454GM-1200		12	12	26	83	45	0,10	4	●
5602R454GM-1400		14	14	26	83	45	0,15	4	●
5602R454GM-1600		16	16	32	92	45	0,15	4	●
5602R454GM-1800		18	18	32	92	45	0,15	4	●
5602R454GM-2000		20	20	38	104	45	0,15	4	●

● Ex stock ○ On demand

* With internal cooling

Application field					
P	M	K	N	S	H
✓	✓	✓			

✓ Very suitable

✓ Suitable

System code > B258

Cutting data > B422

Nonstandard order > B461



A

Torus mill long cutting edge Finishing

Turning

5589R45MGFR02

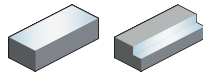

- Type of shank DIN 6535HA
- Helix angle 45°

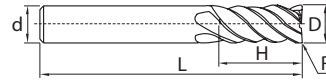

B

Milling

Article	*	Dimensions [mm]					Teeth	Grade
		D	R	d (h6)	H	L		KMG405
5589R45MGFR02-0600		6	0.2	6	19	63	6	●
5589R45MGFR02-0800		8	0.2	8	28	72	6	●
5589R45MGFR02-1000		10	0.2	10	34	84	6	●
5589R45MGFR02-1200		12	0.2	12	40	97	6	●
5589R45MGFR02-1600		16	0.3	16	48	108	8	●
5589R45MGFR02-2000		20	0.3	20	56	122	10	●

● Ex stock ○ On demand

* With internal cooling

C

Drilling

Application field						
P	M	K	N	S	H	
✓	✓	✓				✓ Very suitable
						✓ Suitable

D

Technical Information

E

Index

System code > B258

Cutting data > B422

Nonstandard order > B461

End mill **Semi-finishing**

GM-6E

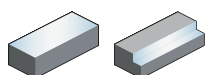

- Factory standard
- Non-centre cutting
- Helix angle 45°

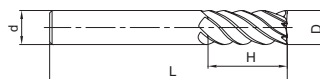

Article	*	Dimensions [mm]				Teeth	Grade
		D	d (h6)	H	L		KMG303
GM-6E-D6.0		6	6	18	60	6	●
GM-6E-D8.0		8	8	20	60	6	●
GM-6E-D10.0		10	10	30	75	6	●
GM-6E-D12.0		12	12	32	75	6	●
GM-6E-D16.0		16	16	40	100	6	●
GM-6E-D20.0		20	20	45	100	6	●

● Ex stock ○ On demand

* With internal cooling

Application field

P	M	K	N	S	H
✓	✓	✓			

✓ Very suitable

✓ Suitable

A

Turning

B

Milling

C

Drilling

D

Technical Information

E

Index

System code > B258

Cutting data > B422

Nonstandard order > B461



A

End mill long cutting edge Semi-finishing

GM-6EL

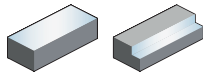

- Factory standard
- Non-centre cutting
- Helix angle 45°

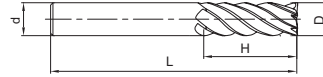

Turning

B

Article	*	Dimensions [mm]				Teeth	Grade
		D	d (h6)	H	L		KMG303
GM-6EL-D6.0		6	6	24	75	6	●
GM-6EL-D8.0		8	8	32	75	6	●
GM-6EL-D10.0		10	10	40	100	6	●
GM-6EL-D12.0		12	12	45	100	6	●
GM-6EL-D16.0		16	16	64	150	6	●
GM-6EL-D20.0		20	20	75	150	6	●

- Ex stock ○ On demand
- * With internal cooling

Milling

C

Application field						
P	M	K	N	S	H	
✓	✓	✓				✓ Very suitable
						✓ Suitable

Drilling

D

Technical Information

E

Index

System code > B258

Cutting data > B422

Nonstandard order > B461

Ball nose cutter **Finishing**

5565R302GF

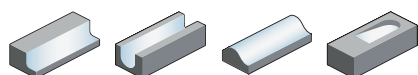

- Type of shank DIN 6535HA
- Centre cutting
- Helix angle 30°

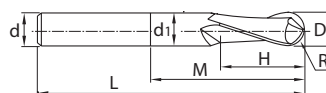

Article	*	Dimensions [mm]							Teeth	Grade
		D	R	d (h6)	d ₁	H	M	L		KMG303
5565R302GF-0300		3	1.5	6	2.8	4	9	57	2	●
5565R302GF-0400		4	2	6	3.7	5	12	57	2	●
5565R302GF-0500		5	2.5	6	4.6	6	15	57	2	●
5565R302GF-0600		6	3	6	5.5	7	20	57	2	●
5565R302GF-0800		8	4	8	7.4	9	26	63	2	●
5565R302GF-1000		10	5	10	9.2	11	31	72	2	●
5565R302GF-1200		12	6	12	11	12	37	83	2	●
5565R302GF-1600		16	8	16	15	16	43	92	2	●
5565R302GF-2000		20	10	20	19	20	50	104	2	●

● Ex stock ○ On demand

* With internal cooling

Application field

P	M	K	N	S	H
✓	✓	✓			

✓ Very suitable

✓ Suitable

System code > B258

Cutting data > B422

Nonstandard order > B461



A

Ball nose cutter Semi-finishing

5665R202GM

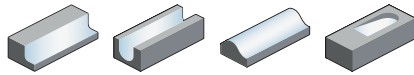

- Type of shank: DIN 6535HB
- Centre cutting
- Helix angle 20°

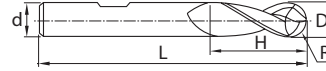

Turning

B

Article	*	Dimensions [mm]						Teeth	Grade
		D	R	d (h6)	d ₁	H	L		KMG303
5665R202GM-0300		3	1.5	6	2.8	4	57	2	●
5665R202GM-0400		4	2	6	3.7	5	57	2	●
5665R202GM-0500		5	2.5	6	4.6	6	57	2	●
5665R202GM-0600		6	3	6	5.5	7	57	2	●
5665R202GM-0800		8	4	8	7.4	9	63	2	●
5665R202GM-1000		10	5	10	9.2	11	72	2	●
5665R202GM-1200		12	6	12	11	12	83	2	●
5665R202GM-1600		16	8	16	15	16	92	2	●
5665R202GM-2000		20	10	20	19	20	104	2	●

Milling

- Ex stock ○ On demand
- * With internal cooling

C

Application field

P	M	K	N	S	H
✓	✓	✓			

- ✓ Very suitable
- ✓ Suitable

Drilling

D

Technical Information

E

Index

System code > B258

Cutting data > B422

Nonstandard order > B461

Ball nose cutter long shank Finishing

5566R302GF

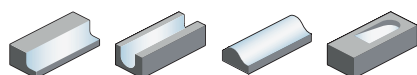

- Type of shank DIN 6535HA
- Centre cutting
- Helix angle 30°

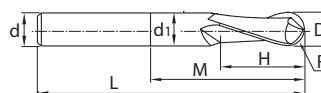

Article	*	Dimensions [mm]							Teeth	Grade
		D	R	d (h6)	d ₁	H	M	L		KMG303
5566R302GF-0300		3	1.5	6	2.8	4	15	75	2	●
5566R302GF-0400		4	2	6	3.7	5	20	75	2	●
5566R302GF-0500		5	2.5	6	4.6	6	25	80	2	●
5566R302GF-0600		6	3	6	5.5	7	60	80	2	●
5566R302GF-0800		8	4	8	7.4	9	65	90	2	●
5566R302GF-1000		10	5	10	9.2	11	40	100	2	●
5566R302GF-1200		12	6	12	11	12	50	120	2	●

● Ex stock ○ On demand

* With internal cooling

Application field

P	M	K	N	S	H
✓	✓	✓			

✓ Very suitable

✓ Suitable

System code > B258

Cutting data > B422

Nonstandard order > B461



A

Ball nose cutter Semi-finishing

GM-2B

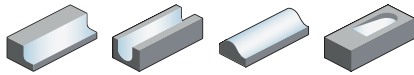

- Factory standard
- Centre cutting
- Helix angle 35°

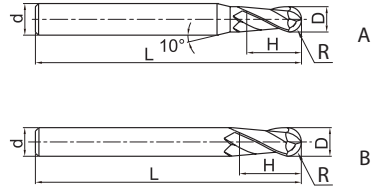

Turning

B

Milling

C

Drilling

D

Technical Information

E

Index

Article	*	Dimensions [mm]					Teeth	Geometry	Grade
		D	R	d (h6)	H	L			
GM-2B-R0.5S		1	0.5	4	2	50	2	A	●
GM-2B-R0.75S		1.5	0.75	4	3	50	2	A	●
GM-2B-R1.0S		2	1	4	4	50	2	A	●
GM-2B-R1.25S		2.5	1.25	4	5	50	2	A	●
GM-2B-R1.5S		3	1.5	4	6	50	2	A	●
GM-2B-R2.0S		4	2	4	8	50	2	B	●
GM-2B-R0.5		1	0.5	6	2	50	2	A	●
GM-2B-R0.75		1.5	0.75	6	3	50	2	A	●
GM-2B-R1.0		2	1	6	4	50	2	A	●
GM-2B-R1.25		2.5	1.25	6	5	50	2	A	○
GM-2B-R1.5		3	1.5	6	6	50	2	A	●
GM-2B-R1.75		3.5	1.75	6	8	50	2	A	○
GM-2B-R2.0		4	2	6	8	50	2	A	●
GM-2B-R2.5		5	2.5	6	10	50	2	A	●
GM-2B-R2.75		5.5	2.75	6	12	50	2	A	○
GM-2B-R3.0		6	3	6	12	50	2	B	●
GM-2B-R3.5		7	3.5	8	14	60	2	A	○
GM-2B-R4.0		8	4	8	16	60	2	B	●
GM-2B-R4.5		9	4.5	10	18	75	2	A	●
GM-2B-R5.0		10	5	10	20	75	2	B	●
GM-2B-R6.0		12	6	12	24	75	2	B	●
GM-2B-R7.0		14	7	14	28	75	2	B	●
GM-2B-R8.0		16	8	16	32	100	2	B	●
GM-2B-R10.0		20	10	20	40	100	2	B	●

● Ex stock ○ On demand

* With internal cooling

Application field

P	M	K	N	S	H
✓	✓	✓			

✓ Very suitable

✓ Suitable

System code > B258

Cutting data > B422

Nonstandard order > B461

Ball nose cutter long shank **Semi-finishing**

GM-2BL

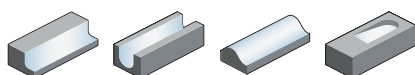

- Factory standard
- Centre cutting
- Helix angle 35°

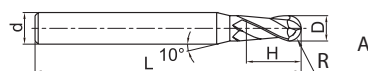

Article	*	Dimensions [mm]					Teeth	Geometry	Grade
		D	R	d (h6)	H	L			KMG303
GM-2BL-R1.0		2	1	6	4	75	2	A	●
GM-2BL-R1.25		2.5	1.25	6	5	75	2	A	●
GM-2BL-R1.5		3	1.5	6	6	75	2	A	●
GM-2BL-R1.75		3.5	1.75	6	8	75	2	A	●
GM-2BL-R2.0		4	2	6	8	75	2	A	●
GM-2BL-R2.5		5	2.5	6	10	75	2	A	●
GM-2BL-R2.75		5.5	2.75	6	12	75	2	A	●
GM-2BL-R3.0		6	3	6	12	75	2	B	●
GM-2BL-R3.5		7	3.5	8	14	75	2	A	●
GM-2BL-R4.0		8	4	8	16	100	2	B	●
GM-2BL-R4.5		9	4.5	10	18	100	2	A	●
GM-2BL-R5.0		10	5	10	20	100	2	B	●
GM-2BL-R6.0		12	6	12	24	100	2	B	●
GM-2BL-R7.0		14	7	14	28	100	2	B	●
GM-2BL-R8.0		16	8	16	32	150	2	B	●
GM-2BL-R10.0		20	10	20	40	150	2	B	●

● Ex stock ○ On demand

* With internal cooling

Application field					
P	M	K	N	S	H
✓	✓	✓			

✓ Very suitable

✓ Suitable

System code > B258

Cutting data > B422

Nonstandard order > B461



A

Ball nose cutter short cutting edge Semi-finishing

GM-2BFP

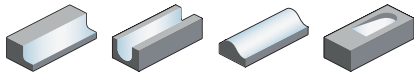

- Factory standard
- Centre cutting
- Helix angle 35°

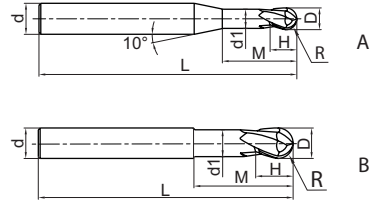

B

Milling

Article	*	Dimensions [mm]							Teeth	Geometry	Grade
		D	R	d (h6)	d ₁	H	M	L			
GM-2BFP-R0.5		1	0.5	6	0.95	1	2.5	75	2	A	●
GM-2BFP-R0.75		1.5	0.75	6	1.45	1	3	75	2	A	○
GM-2BFP-R1.0		2	1	6	1.95	2	4	75	2	A	●
GM-2BFP-R1.5		3	1.5	6	2.85	3	6	75	2	A	○
GM-2BFP-R2.0		4	2	6	3.85	4	8	75	2	A	○
GM-2BFP-R2.5		5	2.5	6	4.85	5	10	75	2	A	○
GM-2BFP-R3.0		6	3	6	5.8	6	12	75	2	B	○
GM-2BFP-R4.0		8	4	8	7.8	8	16	100	2	B	○
GM-2BFP-R5.0		10	5	10	9.6	10	20	100	2	B	○
GM-2BFP-R6.0		12	6	12	11.5	12	24	100	2	B	○
GM-2BFP-R8.0		16	8	16	15.5	16	32	150	2	B	○
GM-2BFP-R10.0		20	10	20	19.5	20	40	150	2	B	○

● Ex stock ○ On demand

* With internal cooling

C

Drilling

D

Technical Information

E

Index

Application field

P	M	K	N	S	H
✓	✓	✓			

✓ Very suitable

✓ Suitable

System code > B258

Cutting data > B422

Nonstandard order > B461

Ball nose cutter **Semi-finishing**

GM-2BS

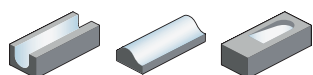

- Factory standard
- Centre cutting
- Helix angle 35°

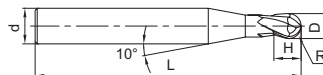

Article	*	Dimensions [mm]					Teeth	Grade
		D	R	d (h6)	H	L		KMG303
GM-2BS-R0.15		0.3	0.15	4	0.5	50	2	●
GM-2BS-R0.20		0.4	0.2	4	0.6	50	2	●
GM-2BS-R0.25		0.5	0.25	4	0.8	50	2	●
GM-2BS-R0.30		0.6	0.3	4	0.9	50	2	●
GM-2BS-R0.35		0.7	0.35	4	1	50	2	●
GM-2BS-R0.40		0.8	0.4	4	1.2	50	2	●
GM-2BS-R0.45		0.9	0.45	4	1.3	50	2	●
GM-2BS-R0.50		1	0.5	4	1.5	50	2	●
GM-2BS-R0.60		1.2	0.6	4	1.8	50	2	●
GM-2BS-R0.70		1.4	0.7	4	2	50	2	●
GM-2BS-R0.75		1.5	0.75	4	2.3	50	2	●
GM-2BS-R0.80		1.6	0.8	4	2.5	50	2	●
GM-2BS-R0.90		1.8	0.9	4	2.7	50	2	●
GM-2BS-R1.00		2	1	4	3	50	2	●
GM-2BS-R1.25		2.5	1.25	4	3.7	50	2	●
GM-2BS-R1.50		3	1.5	4	4.5	50	2	●

- Ex stock ○ On demand
- * With internal cooling

Application field					
P	M	K	N	S	H
✓	✓	✓			

- ✓ Very suitable
- ✓ Suitable

System code > B258

Cutting data > B422

Nonstandard order > B461



A

Ball nose cutter Semi-finishing

GM-2BP

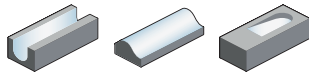

- Factory standard
- Centre cutting
- Helix angle 35°

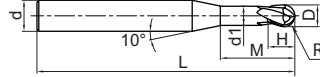

Turning

B

Article	*	Dimensions [mm]							Teeth	Grade KMG303
		D	R	d (h6)	d ₁	H	M	L		
GM-2BP-R0.25-M04		0.5	0.25	4	0.45	0.7	4	50	2	●
GM-2BP-R0.25-M06		0.5	0.25	4	0.45	0.7	6	50	2	●
GM-2BP-R0.3-M04		0.6	0.3	4	0.55	0.9	4	50	2	●
GM-2BP-R0.3-M06		0.6	0.3	4	0.55	0.9	6	50	2	●
GM-2BP-R0.3-M08		0.6	0.3	4	0.55	0.9	8	50	2	●
GM-2BP-R0.4-M04		0.8	0.4	4	0.75	1.2	4	50	2	●
GM-2BP-R0.4-M06		0.8	0.4	4	0.75	1.2	6	50	2	●
GM-2BP-R0.4-M08		0.8	0.4	4	0.75	1.2	8	50	2	●
GM-2BP-R0.4-M10		0.8	0.4	4	0.75	1.2	10	50	2	●
GM-2BP-R0.5-M04		1	0.5	4	0.95	1.5	4	50	2	●
GM-2BP-R0.5-M06		1	0.5	4	0.95	1.5	6	50	2	●
GM-2BP-R0.5-M08		1	0.5	4	0.95	1.5	8	50	2	●
GM-2BP-R0.5-M10		1	0.5	4	0.95	1.5	10	50	2	●
GM-2BP-R0.5-M12		1	0.5	4	0.95	1.5	12	50	2	●
GM-2BP-R0.6-M06		1.2	0.6	4	1.15	1.8	6	50	2	●
GM-2BP-R0.6-M08		1.2	0.6	4	1.15	1.8	8	50	2	●
GM-2BP-R0.6-M12		1.2	0.6	4	1.15	1.8	12	50	2	●
GM-2BP-R0.6-M16		1.2	0.6	4	1.15	1.8	16	50	2	●
GM-2BP-R0.75-M08		1.5	0.75	4	1.45	2.3	8	50	2	●
GM-2BP-R0.75-M12		1.5	0.75	4	1.45	2.3	12	50	2	●
GM-2BP-R0.75-M16		1.5	0.75	4	1.45	2.3	16	50	2	●
GM-2BP-R1.0-M06		2	1	4	1.95	3	6	50	2	●
GM-2BP-R1.0-M08		2	1	4	1.95	3	8	50	2	●
GM-2BP-R1.0-M10		2	1	4	1.95	3	10	50	2	●
GM-2BP-R1.0-M12		2	1	4	1.95	3	12	50	2	●
GM-2BP-R1.0-M16		2	1	4	1.95	3	16	50	2	●
GM-2BP-R1.0-M20		2	1	4	1.95	3	20	50	2	●
GM-2BP-R1.25-M08		2.5	1.25	4	2.4	3.7	8	50	2	●
GM-2BP-R1.25-M12		2.5	1.25	4	2.4	3.7	12	50	2	●
GM-2BP-R1.25-M16		2.5	1.25	4	2.4	3.7	16	60	2	●
GM-2BP-R1.25-M20		2.5	1.25	4	2.4	3.7	20	60	2	●
GM-2BP-R1.5-M08		3	1.5	6	2.85	4.5	8	50	2	●
GM-2BP-R1.5-M10		3	1.5	6	2.85	4.5	10	50	2	●
GM-2BP-R1.5-M12		3	1.5	6	2.85	4.5	12	50	2	●
GM-2BP-R1.5-M16		3	1.5	6	2.85	4.5	16	60	2	●
GM-2BP-R1.5-M20		3	1.5	6	2.85	4.5	20	60	2	●
GM-2BP-R2.0-M10		4	2	6	3.85	6	10	60	2	●

● Ex stock ○ On demand

* With internal cooling

Milling

C

Drilling

D

Technical Information

E

Index

Application field

P	M	K	N	S	H
✓	✓	✓			

✓ Very suitable

✓ Suitable

System code > B258

Cutting data > B422

Nonstandard order > B461

Ball nose cutter **Semi-finishing**

GM-2BP

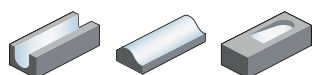

- Factory standard
- Centre cutting
- Helix angle 35°

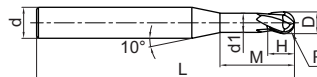

Article	*	Dimensions [mm]							Teeth	Grade
		D	R	d (h6)	d ₁	H	M	L		
GM-2BP-R2.0-M16		4	2	6	3.85	6	16	60	2	●
GM-2BP-R2.0-M20		4	2	6	3.85	6	20	60	2	●
GM-2BP-R2.0-M25		4	2	6	3.85	6	25	60	2	●
GM-2BP-R2.5-M16		5	2.5	6	4.85	7.5	16	60	2	●
GM-2BP-R2.5-M25		5	2.5	6	4.85	7.5	25	70	2	●

● Ex stock ○ On demand

* With internal cooling

Application field					
P	M	K	N	S	H
✓	✓	✓			

✓ Very suitable

✓ Suitable

A

Turning

B

Milling

C

Drilling

D

Technical Information

E

Index

System code > B258

Cutting data > B422

Nonstandard order > B461



A

Ball nose cutter Semi-finishing

GM-4B

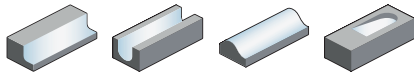

- Factory standard
- Centre cutting
- Helix angle 35°

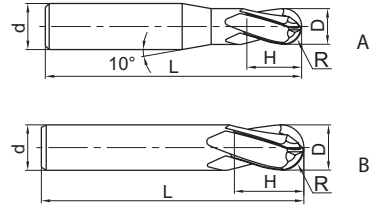

Turning

B

Milling

Article	*	Dimensions [mm]					Teeth	Geometry	Grade
		D	R	d (h6)	H	L			KMG303
GM-4B-R1.5		3	1.5	6	6	50	4	A	●
GM-4B-R2.0		4	2	6	8	50	4	A	●
GM-4B-R2.5		5	2.5	6	10	50	4	A	●
GM-4B-R3.0		6	3	6	12	50	4	B	●
GM-4B-R4.0		8	4	8	16	60	4	B	●
GM-4B-R5.0		10	5	10	20	75	4	B	●
GM-4B-R6.0		12	6	12	24	75	4	B	●
GM-4B-R7.0		14	7	14	28	75	4	B	●
GM-4B-R8.0		16	8	16	32	100	4	B	●
GM-4B-R9.0		18	9	18	36	100	4	B	●
GM-4B-R10.0		20	10	20	40	100	4	B	●

- Ex stock ○ On demand
- * With internal cooling

C

Drilling

Application field

P	M	K	N	S	H
✓	✓	✓			

- ✓ Very suitable
- ✓ Suitable

D

Technical Information

E

Index

System code > B258

Cutting data > B422

Nonstandard order > B461

Ball nose cutter long shank

Semi-finishing

GM-4BL

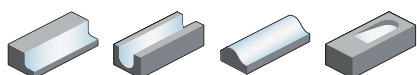

- Factory standard
- Centre cutting
- Helix angle 35°

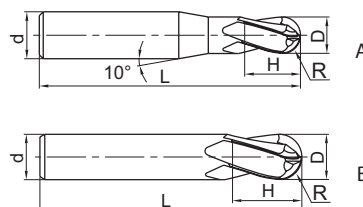

Article	*	Dimensions [mm]					Teeth	Geometry	Grade
		D	R	d (h6)	H	L			KMG303
GM-4BL-R1.5		3	1.5	6	6	75	4	A	●
GM-4BL-R2.0		4	2	6	8	75	4	A	●
GM-4BL-R2.5		5	2.5	6	10	75	4	A	●
GM-4BL-R3.0		6	3	6	12	75	4	B	●
GM-4BL-R4.0		8	4	8	16	100	4	B	●
GM-4BL-R5.0		10	5	10	20	100	4	B	●
GM-4BL-R6.0		12	6	12	24	100	4	B	●
GM-4BL-R7.0		14	7	14	28	100	4	B	●
GM-4BL-R8.0		16	8	16	32	150	4	B	●
GM-4BL-R9.0		18	9	18	36	150	4	B	●
GM-4BL-R10.0		20	10	20	40	150	4	B	●

● Ex stock ○ On demand

* With internal cooling

Application field

P	M	K	N	S	H
✓	✓	✓			

✓ Very suitable

✓ Suitable

System code > B258

Cutting data > B422

Nonstandard order > B461



Torus mill

Semi-finishing

GM-2R

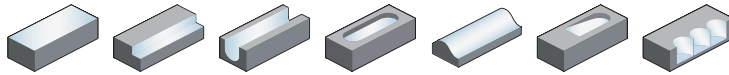

- Factory standard
- Centre cutting
- Helix angle 35°

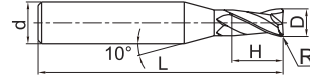

Article	*	Dimensions [mm]					Teeth	Grade
		D	R	d (h6)	H	L		KMG303
GM-2R-D1.0R0.2		1	0.2	4	3	50	2	●
GM-2R-D1.5R0.2		1.5	0.2	4	4	50	2	●
GM-2R-D2.0R0.2		2	0.2	4	6	50	2	●
GM-2R-D2.0R0.5		2	0.5	4	6	50	2	●
GM-2R-D2.5R0.2		2.5	0.2	4	8	50	2	●
GM-2R-D2.5R0.5		2.5	0.5	4	8	50	2	○
GM-2R-D3.0R0.2		3	0.2	4	8	50	2	●
GM-2R-D3.0R0.3		3	0.3	4	8	50	2	●
GM-2R-D3.0R0.5		3	0.5	4	8	50	2	●
GM-2R-D4.0R0.2		4	0.2	4	11	50	2	●
GM-2R-D4.0R0.3		4	0.3	4	11	50	2	●
GM-2R-D4.0R0.5		4	0.5	4	11	50	2	●
GM-2R-D4.0R1.0		4	1	4	11	50	2	○
GM-2R-D5.0R0.3		5	0.3	6	13	50	2	○
GM-2R-D5.0R0.5		5	0.5	6	13	50	2	●
GM-2R-D5.0R1.0		5	1	6	13	50	2	○
GM-2R-D6.0R0.3		6	0.3	6	16	50	2	●
GM-2R-D6.0R0.5		6	0.5	6	16	50	2	●
GM-2R-D6.0R1.0		6	1	6	16	50	2	●
GM-2R-D8.0R0.3		8	0.3	8	20	60	2	●
GM-2R-D8.0R0.5		8	0.5	8	20	60	2	●
GM-2R-D8.0R1.0		8	1	8	20	60	2	○
GM-2R-D10.0R0.5		10	0.5	10	25	75	2	○
GM-2R-D10.0R1.0		10	1	10	25	75	2	○
GM-2R-D10.0R1.5		10	1.5	10	25	75	2	●
GM-2R-D10.0R2.0		10	2	10	25	75	2	○
GM-2R-D12.0R0.5		12	0.5	12	30	75	2	○
GM-2R-D12.0R1.0		12	1	12	30	75	2	○
GM-2R-D12.0R1.5		12	1.5	12	30	75	2	○
GM-2R-D12.0R2.0		12	2	12	30	75	2	●

● Ex stock ○ On demand

* With internal cooling

Application field

P	M	K	N	S	H
✓	✓	✓			

✓ Very suitable

✓ Suitable

System code > B258

Cutting data > B422

Nonstandard order > B461

Torus mill

Semi-finishing

GM-4R

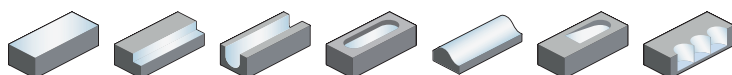

- Factory standard
- Centre cutting
- Helix angle 35°

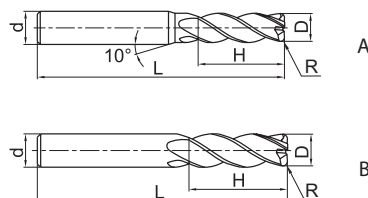

Article	*	Dimensions [mm]					Teeth	Geometry	Grade
		D	R	d (h6)	H	L			KMG303
GM-4R-D3.0R0.2		3	0.2	4	8	50	4	A	●
GM-4R-D4.0R0.3		4	0.3	4	10	50	4	B	○
GM-4R-D4.0R0.5		4	0.5	4	10	50	4	B	●
GM-4R-D5.0R0.5		5	0.5	6	13	50	4	A	●
GM-4R-D5.0R1.0		5	1	6	13	50	4	A	●
GM-4R-D6.0R0.5		6	0.5	6	16	50	4	B	●
GM-4R-D6.0R1.0		6	1	6	16	50	4	B	●
GM-4R-D8.0R0.5		8	0.5	8	20	60	4	B	●
GM-4R-D8.0R1.0		8	1	8	20	60	4	B	●
GM-4R-D10.0R0.5		10	0.5	10	25	75	4	B	●
GM-4R-D10.0R1.0		10	1	10	25	75	4	B	●
GM-4R-D10.0R2.0		10	2	10	25	75	4	B	●
GM-4R-D10.0R3.0		10	3	10	25	75	4	B	●
GM-4R-D12.0R0.5		12	0.5	12	30	75	4	B	●
GM-4R-D12.0R1.0		12	1	12	30	75	4	B	●
GM-4R-D12.0R2.0		12	2	12	30	75	4	B	●
GM-4R-D12.0R3.0		12	3	12	30	75	4	B	●

- Ex stock ○ On demand
- * With internal cooling

Application field					
P	M	K	N	S	H
✓	✓	✓			

- ✓ Very suitable
- ✓ Suitable

System code > B258

Cutting data > B422

Nonstandard order > B461



A

Torus mill long shank

Semi-finishing

GM-4RL

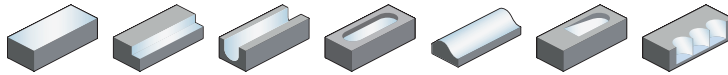

- Factory standard
- Centre cutting
- Helix angle 35°

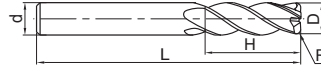

Turning

B

Article	*	Dimensions [mm]					Teeth	Grade
		D	R	d (h6)	H	L		KMG303
GM-4RL-D6.0R0.5		6	0.5	6	16	75	4	●
GM-4RL-D6.0R1.0		6	1	6	16	75	4	●
GM-4RL-D8.0R0.5		8	0.5	8	20	100	4	●
GM-4RL-D8.0R1.0		8	1	8	20	100	4	●
GM-4RL-D10.0R0.5		10	0.5	10	25	100	4	●
GM-4RL-D10.0R1.0		10	1	10	25	100	4	●
GM-4RL-D10.0R2.0		10	2	10	25	100	4	●
GM-4RL-D12.0R0.5		12	0.5	12	30	100	4	●
GM-4RL-D12.0R1.0		12	1	12	30	100	4	●
GM-4RL-D12.0R2.0		12	2	12	30	100	4	●
GM-4RL-D16.0R1.0		16	1	16	45	150	4	●
GM-4RL-D16.0R2.0		16	2	16	45	150	4	●

Milling

C

- Ex stock ○ On demand
- * With internal cooling

Drilling

Application field						
P	M	K	N	S	H	
✓	✓	✓				✓ Very suitable ✓ Suitable

D

Technical Information

E

Index

System code > B258

Cutting data > B422

Nonstandard order > B461

End mill long cutting edge

General roughing

5602R303GR

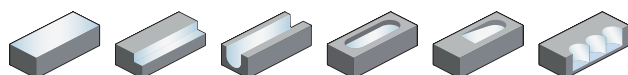

- Type of shank: DIN 6535HB
- Centre cutting
- Helix angle 30°

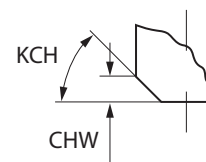
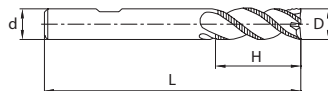

Article	*	Dimensions [mm]					Teeth	Grade	
		D	d (h6)	H	L	KCH		CHW	KMG303
5602R303GR-0600		6	6	13	57	45	0,25	3	●
5602R303GR-0800		8	8	19	63	45	0,25	3	●

- Ex stock ○ On demand
- * With internal cooling

Application field

P	M	K	N	S	H
✓	✓	✓			

- ✓ Very suitable
- ✓ Suitable

A

Turning

B

Milling

C

Drilling

D

Technical Information

E

Index

System code > B258

Cutting data > B422

Nonstandard order > B461



A

End mill long cutting edge General roughing

5602R304GR

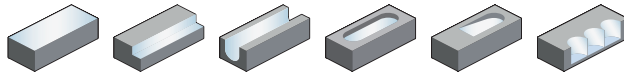

- Type of shank: DIN 6535HB
- Centre cutting
- Helix angle 30°

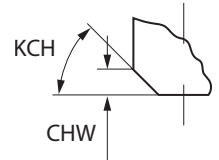
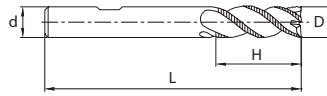

Turning

B

Article	*	Dimensions [mm]						Teeth	Grade
		D	d (h6)	H	L	KCH	CHW		KMG303
5602R304GR-1000		10	10	22	72	45	0,50	4	●
5602R304GR-1200		12	12	26	83	45	0,50	4	●
5602R304GR-1400		14	14	30	90	45	0,50	4	○
5602R304GR-1600		16	16	32	92	45	0,50	4	●
5602R304GR-2000		20	20	38	104	45	0,50	4	●

● Ex stock ○ On demand

* With internal cooling

Milling

C

Application field

P	M	K	N	S	H
✓	✓	✓			

✓ Very suitable

✓ Suitable

Drilling

D

Technical Information

E

Index

System code > B258

Cutting data > B422

Nonstandard order > B461

End mill long cutting edge

General roughing

5602R305GR

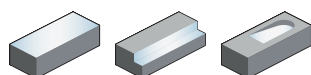

- Type of shank: DIN 6535HB
- Centre cutting
- Helix angle 30°

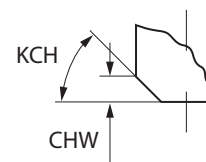
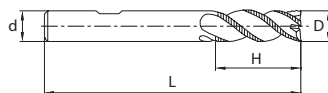

Article	*	Dimensions [mm]					Teeth	Grade	
		D	d (h6)	H	L	KCH		CHW	KMG303
5602R305GR-2500		25	25	45	121	45	0,50	5	o

- Ex stock o On demand
- * With internal cooling

Application field

P	M	K	N	S	H
✓	✓	✓			

- ✓ Very suitable
- ✓ Suitable

System code > B258

Cutting data > B422

Nonstandard order > B461



A

End mill serrated teeth Semi-finishing

GM-4W

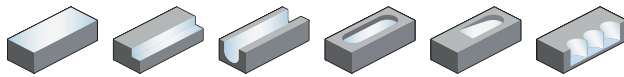

- Factory standard
- Centre cutting
- Helix angle 30°

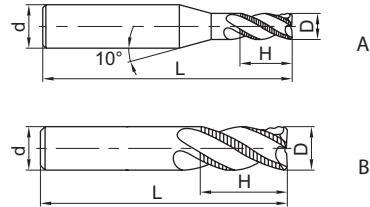

Turning

B

Milling

Article	*	Dimensions [mm]				Teeth	Geometry	Grade
		D	d (h6)	H	L			KMG405
GM-4W-D6.0		6	6	16	50	4	B	●
GM-4W-D7.0		7	8	20	60	4	A	●
GM-4W-D8.0		8	8	20	60	4	B	●
GM-4W-D9.0		9	10	22	75	4	A	●
GM-4W-D10.0		10	10	25	75	4	B	●
GM-4W-D11.0		11	12	26	75	4	A	●
GM-4W-D12.0		12	12	30	75	4	B	●
GM-4W-D16.0		16	16	45	100	4	B	●
GM-4W-D20.0		20	20	45	100	4	B	●

● Ex stock ○ On demand

* With internal cooling

C

Drilling

Application field

P	M	K	N	S	H
✓	✓	✓			

✓ Very suitable

✓ Suitable

D

Technical Information

E

Index

System code > B258

Cutting data > B422

Nonstandard order > B461



PM series

For demanding applications

- For machining of steel to max. 55 HRC and cast iron to heat-resistant alloys.
- Very solid cutting edge with high stiffness for higher cutting speeds and feed rates.
- End mills, ball nose cutters, torus mills and high feed mills
- Diameter range 3.0–20.0 mm

Application fields for machining of steel

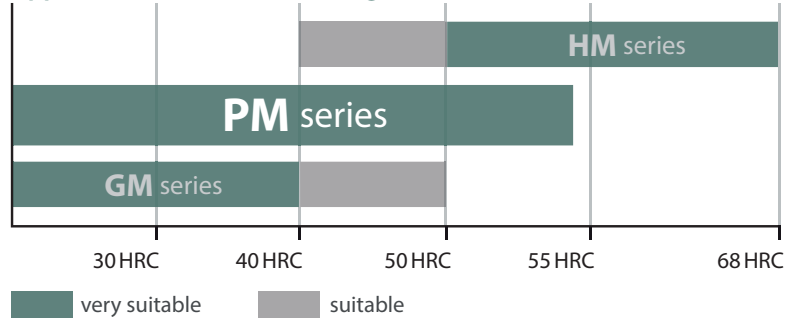

A

End mill High-performance machining

Turning

PM-2E

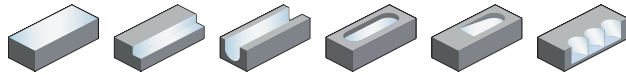

- Factory standard
- Centre cutting
- Helix angle 30°

B

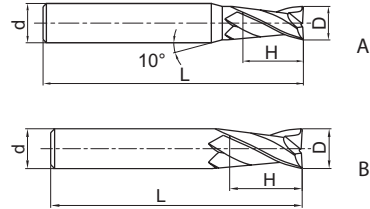

Milling

Article	*	Dimensions [mm]				Teeth	Geometry	Grade
		D	d (h6)	H	L			KMG405
PM-2E-D1.0S		1	4	3	50	2	A	●
PM-2E-D1.5S		1.5	4	4	50	2	A	●
PM-2E-D2.0S		2	4	6	50	2	A	●
PM-2E-D2.5S		2.5	4	8	50	2	A	●
PM-2E-D3.0S		3	4	8	50	2	A	●
PM-2E-D4.0S		4	4	11	50	2	B	●
PM-2E-D1.0		1	6	3	50	2	A	●
PM-2E-D1.5		1.5	6	4	50	2	A	●
PM-2E-D2.0		2	6	6	50	2	A	●
PM-2E-D2.5		2.5	6	8	50	2	A	●
PM-2E-D3.0		3	6	8	50	2	A	●
PM-2E-D3.5		3.5	6	10	50	2	A	●
PM-2E-D4.0		4	6	11	50	2	A	●
PM-2E-D4.5		4.5	6	11	50	2	A	●
PM-2E-D5.0		5	6	13	50	2	A	●
PM-2E-D5.5		5.5	6	16	50	2	A	●
PM-2E-D6.0		6	6	16	50	2	B	●
PM-2E-D7.0		7	8	20	60	2	A	●
PM-2E-D8.0		8	8	20	60	2	B	●
PM-2E-D9.0		9	10	22	75	2	A	●
PM-2E-D10.0		10	10	25	75	2	B	●
PM-2E-D11.0		11	12	26	75	2	A	●
PM-2E-D12.0		12	12	30	75	2	B	●
PM-2E-D14.0		14	14	32	75	2	B	●
PM-2E-D16.0		16	16	45	100	2	B	●
PM-2E-D18.0		18	18	45	100	2	B	○
PM-2E-D20.0		20	20	45	100	2	B	●

C

Drilling

D

Technical Information

- Ex stock ○ On demand
- * With internal cooling

E

Application field

P	M	K	N	S	H
✓	✓	✓			✓

- ✓ Very suitable
- ✓ Suitable

Index

System code > B258

Cutting data > B422

Nonstandard order > B461

End mill long cutting edge **High-performance machining**

PM-2EL

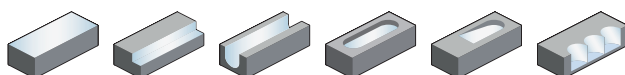

- Factory standard
- Centre cutting
- Helix angle 30°

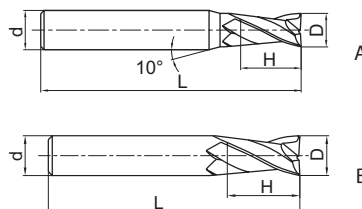

Article	*	Dimensions [mm]				Teeth	Geometry	Grade
		D	d (h6)	H	L			KMG405
PM-2EL-D3.0		3	6	12	75	2	A	●
PM-2EL-D4.0		4	6	15	75	2	A	●
PM-2EL-D5.0		5	6	20	75	2	A	●
PM-2EL-D6.0		6	6	20	75	2	B	●
PM-2EL-D8.0		8	8	25	100	2	B	●
PM-2EL-D10.0		10	10	30	100	2	B	●
PM-2EL-D12.0		12	12	35	100	2	B	●
PM-2EL-D14.0		14	14	40	100	2	B	●
PM-2EL-D16.0		16	16	50	150	2	B	●
PM-2EL-D20.0		20	20	55	150	2	B	●

● Ex stock ○ On demand

* With internal cooling

Application field					
P	M	K	N	S	H
✓	✓	✓			✓

✓ Very suitable

✓ Suitable

System code > B258

Cutting data > B422

Nonstandard order > B461



A

Turning

End mill High-performance machining

PM-4E-G

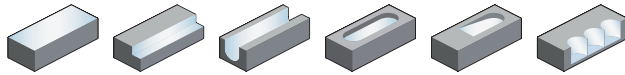

- Factory standard
- Centre cutting
- Helix angle 30°

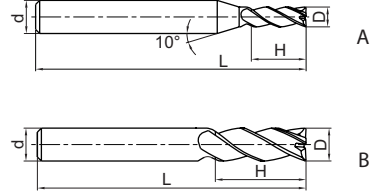

B

Milling

Article	*	Dimensions [mm]				Teeth	Geometry	Grade
		D	d (h6)	H	L			KMG405
PM-4E-D1.0S-G		1	4	3	50	4	A	●
PM-4E-D1.5S-G		1.5	4	4	50	4	A	●
PM-4E-D2.0S-G		2	4	6	50	4	A	●
PM-4E-D2.5S-G		2.5	4	8	50	4	A	●
PM-4E-D3.0S-G		3	4	8	50	4	A	●
PM-4E-D4.0S-G		4	4	11	50	4	B	●
PM-4E-D1.0-G		1	6	3	50	4	A	●
PM-4E-D1.5-G		1.5	6	4	50	4	A	●
PM-4E-D2.0-G		2	6	6	50	4	A	●
PM-4E-D2.5-G		2.5	6	8	50	4	A	●
PM-4E-D3.0-G		3	6	8	50	4	A	●
PM-4E-D3.5-G		3.5	6	10	50	4	A	●
PM-4E-D4.0-G		4	6	11	50	4	A	●
PM-4E-D4.5-G		4.5	6	11	50	4	A	●
PM-4E-D5.0-G		5	6	13	50	4	A	●
PM-4E-D5.5-G		5.5	6	16	50	4	A	●
PM-4E-D6.0-G		6	6	16	50	4	B	●
PM-4E-D7.0-G		7	8	20	60	4	A	●
PM-4E-D8.0-G		8	8	20	60	4	B	●
PM-4E-D9.0-G		9	10	22	75	4	A	●
PM-4E-D10.0-G		10	10	25	75	4	B	●
PM-4E-D11.0-G		11	12	26	75	4	A	●
PM-4E-D12.0-G		12	12	30	75	4	B	●
PM-4E-D14.0-G		14	14	32	75	4	B	●
PM-4E-D16.0-G		16	16	45	100	4	B	●
PM-4E-D18.0-G		18	18	45	100	4	B	●
PM-4E-D20.0-G		20	20	45	100	4	B	●

● Ex stock ○ On demand

* With internal cooling

C

Drilling

D

Technical Information

E

Index

Application field					
P	M	K	N	S	H
✓	✓	✓			✓

✓ Very suitable
 ✓ Suitable

System code > B258

Cutting data > B422

Nonstandard order > B461

End mill long cutting edge

High-performance machining

PM-4EL-G

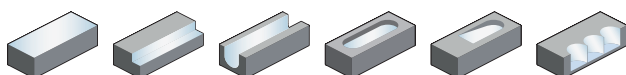

- Factory standard
- Centre cutting
- Helix angle 30°

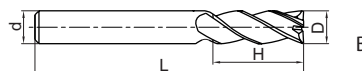
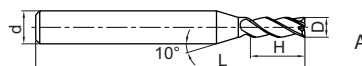

Article	*	Dimensions [mm]				Teeth	Geometry	Grade
		D	d (h6)	H	L			KMG405
PM-4EL-D3.0-G		3	6	12	75	4	A	●
PM-4EL-D4.0-G		4	6	15	75	4	A	●
PM-4EL-D5.0-G		5	6	20	75	4	A	●
PM-4EL-D6.0-G		6	6	20	75	4	B	●
PM-4EL-D8.0-G		8	8	25	100	4	B	●
PM-4EL-D10.0-G		10	10	30	100	4	B	●
PM-4EL-D12.0-G		12	12	35	100	4	B	●
PM-4EL-D14.0-G		14	14	40	100	4	B	●
PM-4EL-D16.0-G		16	16	50	150	4	B	●
PM-4EL-D20.0-G		20	20	55	150	4	B	●

● Ex stock ○ On demand

* With internal cooling

Application field					
P	M	K	N	S	H
✓	✓	✓			✓

✓ Very suitable

✓ Suitable

System code > B258

Cutting data > B422

Nonstandard order > B461



A

End mill extra long cutting edge High-performance machining

PM-4EX-G

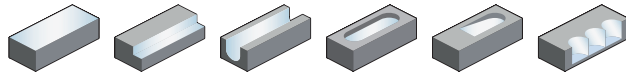

- Factory standard
- Centre cutting
- Helix angle 30°

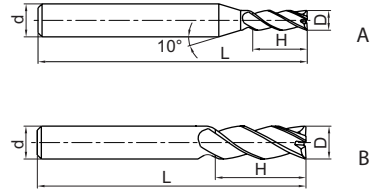

Turning

B

Article	*	Dimensions [mm]				Teeth	Geometry	Grade
		D	d (h6)	H	L			KMG405
PM-4EX-D3.0-G		3	6	20	75	4	A	●
PM-4EX-D4.0-G		4	6	25	75	4	A	●
PM-4EX-D5.0-G		5	6	30	75	4	A	●
PM-4EX-D6.0-G		6	6	30	75	4	B	●
PM-4EX-D8.0-G		8	8	40	100	4	B	●
PM-4EX-D10.0-G		10	10	50	110	4	B	●
PM-4EX-D12.0-G		12	12	50	110	4	B	●
PM-4EX-D16.0-G		16	16	70	150	4	B	●
PM-4EX-D20.0-G		20	20	75	150	4	B	●

● Ex stock ○ On demand

* With internal cooling

Milling

C

Application field

P	M	K	N	S	H
✓	✓	✓			✓

✓ Very suitable

✓ Suitable

Drilling

D

System code > B258

Cutting data > B422

Nonstandard order > B461

Technical Information

E

Index

End mill **High-performance machining**

PM-4E

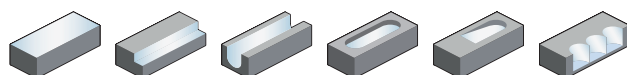

- Factory standard
- Centre cutting
- Helix angle 45°

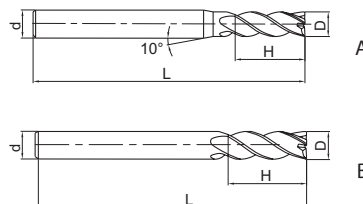

Article	*	Dimensions [mm]				Teeth	Geometry	Grade
		D	d (h6)	H	L			KMG405
PM-4E-D1.0S		1	4	3	50	4	A	●
PM-4E-D1.5S		1.5	4	4	50	4	A	●
PM-4E-D2.0S		2	4	6	50	4	A	●
PM-4E-D2.5S		2.5	4	8	50	4	A	●
PM-4E-D3.0S		3	4	8	50	4	A	●
PM-4E-D4.0S		4	4	11	50	4	B	●
PM-4E-D1.0		1	6	3	50	4	A	●
PM-4E-D1.5		1.5	6	4	50	4	A	●
PM-4E-D2.0		2	6	6	50	4	A	●
PM-4E-D2.5		2.5	6	8	50	4	A	●
PM-4E-D3.0		3	6	8	50	4	A	●
PM-4E-D3.5		3.5	6	10	50	4	A	●
PM-4E-D4.0		4	6	11	50	4	A	●
PM-4E-D4.5		4.5	6	11	50	4	A	●
PM-4E-D5.0		5	6	13	50	4	A	●
PM-4E-D5.5		5.5	6	16	50	4	A	●
PM-4E-D6.0		6	6	16	50	4	B	●
PM-4E-D7.0		7	8	20	60	4	A	●
PM-4E-D8.0		8	8	20	60	4	B	●
PM-4E-D9.0		9	10	22	75	4	A	●
PM-4E-D10.0		10	10	25	75	4	B	●
PM-4E-D11.0		11	12	26	75	4	A	●
PM-4E-D12.0		12	12	30	75	4	B	●
PM-4E-D14.0		14	14	32	75	4	B	●
PM-4E-D16.0		16	16	45	100	4	B	●
PM-4E-D18.0		18	18	45	100	4	B	●
PM-4E-D20.0		20	20	45	100	4	B	●

● Ex stock ○ On demand

* With internal cooling

Application field					
P	M	K	N	S	H
✓	✓	✓			✓

✓ Very suitable

✓ Suitable

System code > B258

Cutting data > B422

Nonstandard order > B461



A

End mill long cutting edge High-performance machining

PM-4EL

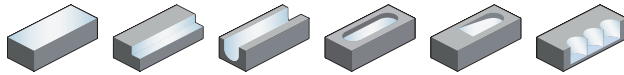

- Factory standard
- Centre cutting
- Helix angle 45°

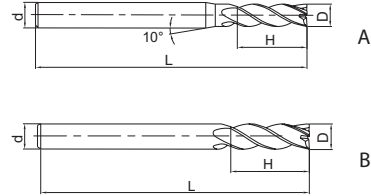

Turning

B

Article	*	Dimensions [mm]				Teeth	Geometry	Grade
		D	d (h6)	H	L			KMG405
PM-4EL-D3.0		3	6	12	75	4	A	●
PM-4EL-D4.0		4	6	15	75	4	A	●
PM-4EL-D5.0		5	6	20	75	4	A	●
PM-4EL-D6.0		6	6	20	75	4	B	●
PM-4EL-D8.0		8	8	25	100	4	B	●
PM-4EL-D10.0		10	10	30	100	4	B	●
PM-4EL-D12.0		12	12	35	100	4	B	●
PM-4EL-D14.0		14	14	40	100	4	B	●
PM-4EL-D16.0		16	16	50	150	4	B	●
PM-4EL-D20.0		20	20	55	150	4	B	●

- Ex stock ○ On demand
- * With internal cooling

Milling

C

Application field

P	M	K	N	S	H
✓	✓	✓			✓

- ✓ Very suitable
- ✓ Suitable

Drilling

D

System code > B258

Cutting data > B422

Nonstandard order > B461

Technical Information

E

Index

End mill **High-performance machining**

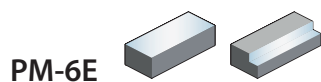

- Factory standard
- Non-centre cutting
- Helix angle 45°

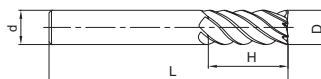

Article	*	Dimensions [mm]				Teeth	Grade
		D	d (h6)	H	L		KMG405
PM-6E-D6.0		6	6	18	60	6	●
PM-6E-D8.0		8	8	20	60	6	●
PM-6E-D10.0		10	10	30	75	6	●
PM-6E-D12.0		12	12	32	75	6	●
PM-6E-D16.0		16	16	40	100	6	●
PM-6E-D20.0		20	20	45	100	6	●

● Ex stock ○ On demand

* With internal cooling

Application field

P	M	K	N	S	H
✓	✓	✓			✓

✓ Very suitable

✓ Suitable

A

Turning

B

Milling

C

Drilling

D

Technical Information

E

Index

System code > B258

Cutting data > B422

Nonstandard order > B461



A

End mill long cutting edge High-performance machining

Turning

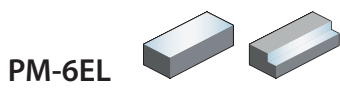

PM-6EL

- Factory standard
- Non-centre cutting
- Helix angle 45°

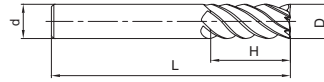

B

Milling

Article	*	Dimensions [mm]				Teeth	Grade
		D	d (h6)	H	L		KMG405
PM-6EL-D6.0		6	6	24	75	6	●
PM-6EL-D8.0		8	8	32	75	6	●
PM-6EL-D10.0		10	10	40	100	6	●
PM-6EL-D12.0		12	12	45	100	6	●
PM-6EL-D16.0		16	16	64	150	6	●
PM-6EL-D20.0		20	20	75	150	6	●

- Ex stock ○ On demand
- * With internal cooling

C

Drilling

Application field

P	M	K	N	S	H
✓	✓	✓			✓

- ✓ Very suitable
- ✓ Suitable

D

Technical Information

E

Index

System code > B258

Cutting data > B422

Nonstandard order > B461

Ball nose cutter **High-performance machining**

PM-2B

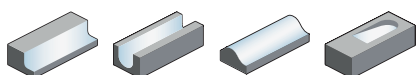

- Factory standard
- Centre cutting
- Helix angle 30°

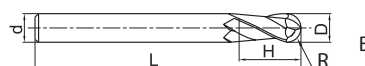
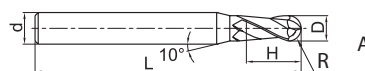

Article	*	Dimensions [mm]					Teeth	Geometry	Grade
		D	R	d (h6)	H	L			KMG405
PM-2B-R0.5S		1	0.5	4	2	50	2	A	●
PM-2B-R0.75S		1.5	0.75	4	3	50	2	A	●
PM-2B-R1.0S		2	1	4	4	50	2	A	●
PM-2B-R1.25S		2.5	1.25	4	5	50	2	A	●
PM-2B-R1.5S		3	1.5	4	6	50	2	A	●
PM-2B-R2.0S		4	2	4	8	50	2	B	●
PM-2B-R0.5		1	0.5	6	2	50	2	A	●
PM-2B-R0.75		1.5	0.75	6	3	50	2	A	●
PM-2B-R1.0		2	1	6	4	50	2	A	●
PM-2B-R1.25		2.5	1.25	6	5	50	2	A	●
PM-2B-R1.5		3	1.5	6	6	50	2	A	●
PM-2B-R1.75		3.5	1.75	6	8	50	2	A	●
PM-2B-R2.0		4	2	6	8	50	2	A	●
PM-2B-R2.5		5	2.5	6	10	50	2	A	●
PM-2B-R2.75		5.5	2.75	6	12	50	2	A	●
PM-2B-R3.0		6	3	6	12	50	2	B	●
PM-2B-R3.5		7	3.5	8	14	60	2	A	●
PM-2B-R4.0		8	4	8	16	60	2	B	●
PM-2B-R4.5		9	4.5	10	18	75	2	A	●
PM-2B-R5.0		10	5	10	20	75	2	B	●
PM-2B-R6.0		12	6	12	24	75	2	B	●
PM-2B-R7.0		14	7	14	28	75	2	B	●
PM-2B-R8.0		16	8	16	32	100	2	B	●
PM-2B-R10.0		20	10	20	40	100	2	B	●

● Ex stock ○ On demand

* With internal cooling

Application field					
P	M	K	N	S	H
✓	✓	✓			✓

✓ Very suitable

✓ Suitable

System code > B258

Cutting data > B422

Nonstandard order > B461



Ball nose cutter long shank High-performance machining

PM-2BL

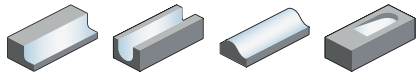

- Factory standard
- Centre cutting
- Helix angle 30°

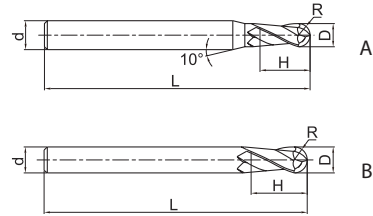

Article	*	Dimensions [mm]					Teeth	Geometry	Grade
		D	R	d (h6)	H	L			KMG405
PM-2BL-R1.0		2	1	6	4	75	2	A	●
PM-2BL-R1.25		2.5	1.25	6	5	75	2	A	●
PM-2BL-R1.5		3	1.5	6	6	75	2	A	●
PM-2BL-R1.75		3.5	1.75	6	8	75	2	A	●
PM-2BL-R2.0		4	2	6	8	75	2	A	●
PM-2BL-R2.5		5	2.5	6	10	75	2	A	●
PM-2BL-R2.75		5.5	2.75	6	12	75	2	A	●
PM-2BL-R3.0		6	3	6	12	75	2	B	●
PM-2BL-R3.5		7	3.5	8	14	75	2	A	●
PM-2BL-R4.0		8	4	8	16	100	2	B	●
PM-2BL-R4.5		9	4.5	10	18	100	2	A	●
PM-2BL-R5.0		10	5	10	20	100	2	B	●
PM-2BL-R6.0		12	6	12	24	100	2	B	●
PM-2BL-R7.0		14	7	14	28	100	2	B	●
PM-2BL-R8.0		16	8	16	32	150	2	B	●
PM-2BL-R10.0		20	10	20	40	150	2	B	●

● Ex stock ○ On demand

* With internal cooling

Application field

P	M	K	N	S	H
✓	✓	✓			✓

✓ Very suitable

✓ Suitable

System code > B258

Cutting data > B422

Nonstandard order > B461

Ball nose cutter short cutting edge **High-performance machining**

PM-2BFP

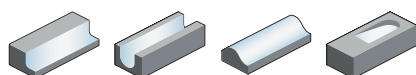

- Factory standard
- Centre cutting
- Helix angle 30°

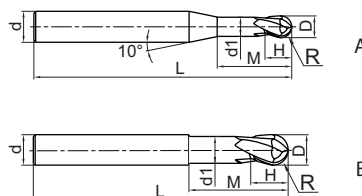

Article	*	Dimensions [mm]							Teeth	Geometry	Grade
		D	R	d (h6)	d _i	H	M	L			
PM-2BFP-R0.5		1	0.5	6	0.95	1	2.5	75	2	A	●
PM-2BFP-R0.75		1.5	0.75	6	1.45	1.5	3	75	2	A	●
PM-2BFP-R1.0		2	1	6	1.95	2	4	75	2	A	●
PM-2BFP-R1.5		3	1.5	6	2.85	3	6	75	2	A	●
PM-2BFP-R2.0		4	2	6	3.85	4	8	75	2	A	●
PM-2BFP-R2.5		5	2.5	6	4.85	5	10	75	2	A	●
PM-2BFP-R3.0		6	3	6	5.8	6	12	75	2	B	●
PM-2BFP-R4.0		8	4	8	7.8	8	16	100	2	B	●
PM-2BFP-R5.0		10	5	10	9.6	10	20	100	2	B	●
PM-2BFP-R6.0		12	6	12	11.5	12	24	100	2	B	●
PM-2BFP-R8.0		16	8	16	15.5	16	32	150	2	B	●
PM-2BFP-R10.0		20	10	20	19.5	20	40	150	2	B	●

● Ex stock ○ On demand

* With internal cooling

Application field					
P	M	K	N	S	H
✓	✓	✓			✓

✓ Very suitable

✓ Suitable

System code > B258

Cutting data > B422

Nonstandard order > B461



Ball nose cutter conical neck

High-performance machining

PM-2BC

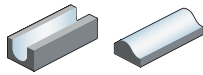

- Straight shank
- Centre cutting
- Helix angle 30°

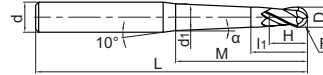

Article	*	Dimensions [mm]										Teeth	Grade KMG405
		D	R	d (h6)	d ₁	M	H	L	α	l ₁			
PM-2BC05-R0.25-M03		0.5	0.25	4	0.49	3	0.5	50	0.5	1.5	2	○	
PM-2BC05-R0.25-M05		0.5	0.25	4	0.53	5	0.5	50	0.5	1.5	2	○	
PM-2BC10-R0.25-M03		0.5	0.25	4	0.52	3	0.5	50	1	1.5	2	○	
PM-2BC10-R0.25-M05		0.5	0.25	4	0.59	5	0.5	50	1	1.5	2	○	
PM-2BC15-R0.25-M03		0.5	0.25	4	0.54	3	0.5	50	1.5	1.5	2	○	
PM-2BC15-R0.25-M05		0.5	0.25	4	0.65	5	0.5	50	1.5	1.5	2	○	
PM-2BC05-R0.30-M05		0.6	0.3	4	0.62	5	0.6	50	0.5	1.6	2	○	
PM-2BC05-R0.30-M08		0.6	0.3	4	0.68	8	0.6	50	0.5	1.6	2	○	
PM-2BC10-R0.30-M05		0.6	0.3	4	0.68	5	0.6	50	1	1.6	2	○	
PM-2BC10-R0.30-M08		0.6	0.3	4	0.79	8	0.6	50	1	1.6	2	○	
PM-2BC10-R0.30-M10		0.6	0.3	4	0.86	10	0.6	50	1	1.6	2	○	
PM-2BC10-R0.30-M12		0.6	0.3	4	0.93	12	0.6	50	1	1.6	2	○	
PM-2BC10-R0.30-M15		0.6	0.3	4	1.03	15	0.6	50	1	1.6	2	○	
PM-2BC15-R0.30-M05		0.6	0.3	4	0.74	5	0.6	50	1.5	1.6	2	○	
PM-2BC15-R0.30-M08		0.6	0.3	4	0.9	8	0.6	50	1.5	1.6	2	○	
PM-2BC05-R0.40-M08		0.8	0.4	4	0.87	8	0.8	50	0.5	1.8	2	○	
PM-2BC10-R0.40-M08		0.8	0.4	4	0.98	8	0.8	50	1	1.8	2	○	
PM-2BC15-R0.40-M08		0.8	0.4	4	1.09	8	0.8	50	1.5	1.8	2	○	
PM-2BC05-R0.40-M12		0.8	0.4	4	0.94	12	0.8	60	0.5	1.8	2	○	
PM-2BC10-R0.40-M12		0.8	0.4	4	1.12	12	0.8	60	1	1.8	2	○	
PM-2BC15-R0.40-M12		0.8	0.4	4	1.3	12	0.8	60	1.5	1.8	2	○	
PM-2BC05-R0.50-M10		1	0.5	6	1.08	10	1	60	0.5	2.5	2	○	
PM-2BC05-R0.50-M15		1	0.5	6	1.16	15	1	60	0.5	2.5	2	○	
PM-2BC10-R0.50-M10		1	0.5	6	1.21	10	1	60	1	2.5	2	○	
PM-2BC10-R0.50-M15		1	0.5	6	1.38	15	1	60	1	2.5	2	○	
PM-2BC15-R0.50-M10		1	0.5	6	1.34	10	1	60	1.5	2.5	2	○	
PM-2BC15-R0.50-M15		1	0.5	6	1.6	15	1	60	1.5	2.5	2	○	
PM-2BC20-R0.50-M15		1	0.5	6	1.82	15	1	60	2	2.5	2	○	
PM-2BC05-R0.50-M20		1	0.5	6	1.25	20	1	70	0.5	2.5	2	○	
PM-2BC05-R0.50-M25		1	0.5	6	1.34	25	1	70	0.5	2.5	2	○	
PM-2BC05-R0.50-M30		1	0.5	6	1.42	30	1	70	0.5	2.5	2	○	
PM-2BC10-R0.50-M20		1	0.5	6	1.56	20	1	70	1	2.5	2	○	
PM-2BC10-R0.50-M25		1	0.5	6	1.73	25	1	70	1	2.5	2	○	
PM-2BC10-R0.50-M30		1	0.5	6	1.91	30	1	70	1	2.5	2	○	
PM-2BC15-R0.50-M20		1	0.5	6	1.86	20	1	70	1.5	2.5	2	○	
PM-2BC20-R0.50-M20		1	0.5	6	2.17	20	1	70	2	2.5	2	○	
PM-2BC30-R0.50-M20		1	0.5	6	2.78	20	1	70	3	2.5	2	○	

● Ex stock ○ On demand

* With internal cooling

Application field

P	M	K	N	S	H
✓	✓	✓			✓

✓ Very suitable

✓ Suitable

System code > B258

Cutting data > B422

Nonstandard order > B461

Ball nose cutter conical neck

High-performance machining

PM-2BC

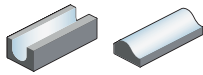

- Straight shank
- Centre cutting
- Helix angle 30°

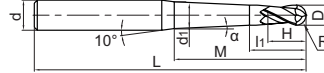

Article	*	Dimensions [mm]										Grade	
		D	R	d (h6)	d ₁	M	H	L	α	l ₁	Teeth	KMG405	
PM-2BC50-R0.50-M20		1	0.5	6	4.01	20	1	70	5	2.5	2	○	
PM-2BC10-R0.50-M35		1	0.5	6	2.08	35	1	80	1	2.5	2	○	
PM-2BC05-R0.60-M12		1.2	0.6	6	1.31	12	1.2	60	0.5	2.7	2	○	
PM-2BC10-R0.60-M12		1.2	0.6	6	1.47	12	1.2	60	1	2.7	2	○	
PM-2BC15-R0.60-M12		1.2	0.6	6	1.63	12	1.2	60	1.5	2.7	2	○	
PM-2BC05-R0.60-M24		1.2	0.6	6	1.52	24	1.2	70	0.5	2.7	2	○	
PM-2BC10-R0.60-M24		1.2	0.6	6	1.89	24	1.2	70	1	2.7	2	○	
PM-2BC15-R0.60-M24		1.2	0.6	6	2.26	24	1.2	70	1.5	2.7	2	○	
PM-2BC05-R0.75-M10		1.5	0.75	6	1.57	10	1.5	60	0.5	3	2	○	
PM-2BC05-R0.75-M15		1.5	0.75	6	1.65	15	1.5	60	0.5	3	2	○	
PM-2BC10-R0.75-M10		1.5	0.75	6	1.69	10	1.5	60	1	3	2	○	
PM-2BC10-R0.75-M15		1.5	0.75	6	1.86	15	1.5	60	1	3	2	○	
PM-2BC15-R0.75-M10		1.5	0.75	6	1.81	10	1.5	60	1.5	3	2	○	
PM-2BC15-R0.75-M15		1.5	0.75	6	2.07	15	1.5	60	1.5	3	2	○	
PM-2BC05-R0.75-M30		1.5	0.75	6	1.92	30	1.5	70	0.5	3	2	○	
PM-2BC10-R0.75-M20		1.5	0.75	6	2.04	20	1.5	70	1	3	2	○	
PM-2BC10-R0.75-M30		1.5	0.75	6	2.39	30	1.5	70	1	3	2	○	
PM-2BC15-R0.75-M30		1.5	0.75	6	2.86	30	1.5	70	1.5	3	2	○	
PM-2BC05-R1.0-M20		2	1	6	2.18	20	2	60	0.5	4	2	○	
PM-2BC10-R1.0-M20		2	1	6	2.46	20	2	60	1	4	2	○	
PM-2BC10-R1.0-M25		2	1	6	2.64	25	2	60	1	4	2	○	
PM-2BC15-R1.0-M20		2	1	6	2.74	20	2	60	1.5	4	2	○	
PM-2BC05-R1.0-M30		2	1	6	2.36	30	2	70	0.5	4	2	○	
PM-2BC10-R1.0-M30		2	1	6	2.81	30	2	70	1	4	2	○	
PM-2BC15-R1.0-M30		2	1	6	3.27	30	2	70	1.5	4	2	○	
PM-2BC20-R1.0-M30		2	1	6	3.72	30	2	70	2	4	2	○	
PM-2BC30-R1.0-M30		2	1	6	4.63	30	2	70	3	4	2	○	
PM-2BC05-R1.0-M40		2	1	6	2.53	40	2	80	0.5	4	2	○	
PM-2BC10-R1.0-M35		2	1	6	2.99	35	2	80	1	4	2	○	
PM-2BC10-R1.0-M40		2	1	6	3.16	40	2	80	1	4	2	○	
PM-2BC15-R1.0-M40		2	1	6	3.79	40	2	80	1.5	4	2	○	
PM-2BC20-R1.0-M40		2	1	6	4.42	40	2	80	2	4	2	○	
PM-2BC30-R1.0-M40		2	1	6	5.68	40	2	80	3	4	2	○	
PM-2BC10-R1.0-M50		2	1	6	3.51	50	2	90	1	4	2	○	
PM-2BC05-R1.5-M30		3	1.5	6	3.32	30	3	70	0.5	6	2	○	
PM-2BC10-R1.5-M30		3	1.5	6	3.74	30	3	70	1	6	2	○	
PM-2BC15-R1.5-M30		3	1.5	6	4.16	30	3	70	1.5	6	2	○	

● Ex stock ○ On demand

* With internal cooling

Application field					
P	M	K	N	S	H
✓	✓	✓			✓

✓ Very suitable

✓ Suitable

System code > B258

Cutting data > B422

Nonstandard order > B461



A

Ball nose cutter conical neck High-performance machining

Turning

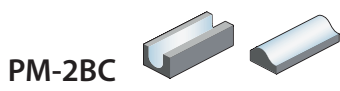

PM-2BC

- Straight shank
- Centre cutting
- Helix angle 30°

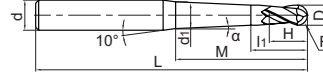

B

Milling

Article	*	Dimensions [mm]										Teeth	Grade
		D	R	d (h6)	d ₁	M	H	L	α	I ₁	KMG405		
PM-2BC05-R1.5-M40		3	1.5	6	3.5	40	3	80	0.5	6	2	○	
PM-2BC10-R1.5-M40		3	1.5	6	4.09	40	3	80	1	6	2	○	
PM-2BC15-R1.5-M40		3	1.5	6	4.69	40	3	80	1.5	6	2	○	
PM-2BC05-R1.5-M50		3	1.5	6	3.67	50	3	90	0.5	6	2	○	
PM-2BC10-R1.5-M50		3	1.5	6	4.44	50	3	90	1	6	2	○	
PM-2BC15-R1.5-M50		3	1.5	6	5.21	50	3	90	1.5	6	2	○	
PM-2BC05-R2.0-M60		4	2	6	4.83	60	4	110	0.5	7	2	○	
PM-2BC10-R2.0-M60		4	2	6	5.76	60	4	110	1	7	2	○	

- Ex stock ○ On demand
- * With internal cooling

C

Drilling

Application field						
P	M	K	N	S	H	
✓	✓	✓			✓	✓ Very suitable ✓ Suitable

D

Technical Information

E

Index



Ball nose cutter **High-performance machining**

PM-4B

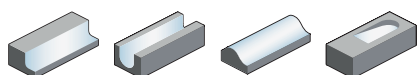

- Factory standard
- Centre cutting
- Helix angle 30°

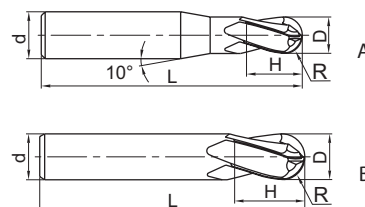

Article	*	Dimensions [mm]					Teeth	Geometry	Grade
		D	R	d (h6)	H	L			KMG405
PM-4B-R1.5		3	1.5	6	6	50	4	A	●
PM-4B-R2.0		4	2	6	8	50	4	A	●
PM-4B-R2.5		5	2.5	6	10	50	4	A	●
PM-4B-R3.0		6	3	6	12	50	4	B	●
PM-4B-R4.0		8	4	8	16	60	4	B	●
PM-4B-R5.0		10	5	10	20	75	4	B	●
PM-4B-R6.0		12	6	12	24	75	4	B	●
PM-4B-R7.0		14	7	14	28	75	4	B	●
PM-4B-R8.0		16	8	16	32	100	4	B	●
PM-4B-R9.0		18	9	18	36	100	4	B	●
PM-4B-R10.0		20	10	20	40	100	4	B	●

● Ex stock ○ On demand

* With internal cooling

Application field

P	M	K	N	S	H
✓	✓	✓			✓

✓ Very suitable

✓ Suitable

System code > B258

Cutting data > B422

Nonstandard order > B461



A

Ball nose cutter long shank High-performance machining

PM-4BL

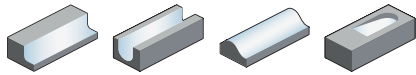

- Factory standard
- Centre cutting
- Helix angle 30°

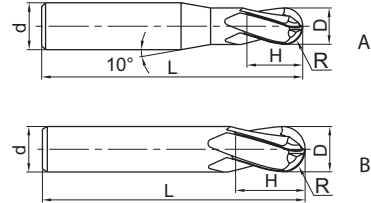

Turning

B

Article	*	Dimensions [mm]					Teeth	Geometry	Grade
		D	R	d (h6)	H	L			KMG405
PM-4BL-R1.5		3	1.5	6	6	75	4	A	●
PM-4BL-R2.0		4	2	6	8	75	4	A	●
PM-4BL-R2.5		5	2.5	6	10	75	4	A	●
PM-4BL-R3.0		6	3	6	12	75	4	B	●
PM-4BL-R4.0		8	4	8	16	100	4	B	●
PM-4BL-R5.0		10	5	10	20	100	4	B	●
PM-4BL-R6.0		12	6	12	24	100	4	B	●
PM-4BL-R7.0		14	7	14	28	100	4	B	●
PM-4BL-R8.0		16	8	16	32	150	4	B	●
PM-4BL-R9.0		18	9	18	36	150	4	B	●
PM-4BL-R10.0		20	10	20	40	150	4	B	●

- Ex stock ○ On demand
- * With internal cooling

Milling

C

Application field

P	M	K	N	S	H
✓	✓	✓			✓

- ✓ Very suitable
- ✓ Suitable

Drilling

D

Technical Information

E

Index

System code > B258

Cutting data > B422

Nonstandard order > B461

Torus mill

High-performance machining

PM-2R

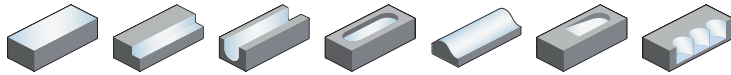

- Factory standard
- Centre cutting
- Helix angle 30°

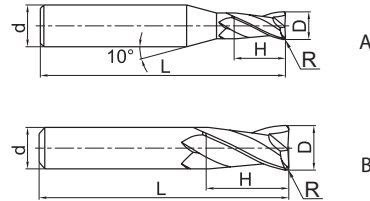

Article	*	Dimensions [mm]					Teeth	Geometry	Grade
		D	R	d (h6)	H	L			KMG405
PM-2R-D1.0R0.2		1	0.2	4	3	50	2	A	●
PM-2R-D1.5R0.2		1.5	0.2	4	4	50	2	A	●
PM-2R-D2.0R0.2		2	0.2	4	6	50	2	A	●
PM-2R-D2.0R0.5		2	0.5	4	6	50	2	A	●
PM-2R-D2.5R0.2		2.5	0.2	4	8	50	2	A	●
PM-2R-D2.5R0.5		2.5	0.5	4	8	50	2	A	●
PM-2R-D3.0R0.2		3	0.2	4	8	50	2	A	●
PM-2R-D3.0R0.3		3	0.3	4	8	50	2	A	●
PM-2R-D3.0R0.5		3	0.5	4	8	50	2	A	●
PM-2R-D4.0R0.2		4	0.2	4	11	50	2	B	●
PM-2R-D4.0R0.3		4	0.3	4	11	50	2	B	●
PM-2R-D4.0R0.5		4	0.5	4	11	50	2	B	●
PM-2R-D4.0R1.0		4	1	4	11	50	2	B	●
PM-2R-D5.0R0.3		5	0.3	6	13	50	2	A	●
PM-2R-D5.0R0.5		5	0.5	6	13	50	2	A	●
PM-2R-D5.0R1.0		5	1	6	13	50	2	A	●
PM-2R-D6.0R0.3		6	0.3	6	16	50	2	B	●
PM-2R-D6.0R0.5		6	0.5	6	16	50	2	B	●
PM-2R-D6.0R1.0		6	1	6	16	50	2	B	●
PM-2R-D8.0R0.3		8	0.3	8	20	60	2	B	○
PM-2R-D8.0R0.5		8	0.5	8	20	60	2	B	●
PM-2R-D8.0R1.0		8	1	8	20	60	2	B	●
PM-2R-D10.0R0.5		10	0.5	10	25	75	2	B	●
PM-2R-D10.0R1.0		10	1	10	25	75	2	B	●
PM-2R-D10.0R1.5		10	1.5	10	25	75	2	B	●
PM-2R-D10.0R2.0		10	2	10	25	75	2	B	●
PM-2R-D12.0R0.5		12	0.5	12	30	75	2	B	●
PM-2R-D12.0R1.0		12	1	12	30	75	2	B	●
PM-2R-D12.0R1.5		12	1.5	12	30	75	2	B	●
PM-2R-D12.0R2.0		12	2	12	30	75	2	B	●

● Ex stock ○ On demand

* With internal cooling

Application field					
P	M	K	N	S	H
✓	✓	✓			✓

✓ Very suitable

✓ Suitable

System code > B258

Cutting data > B422

Nonstandard order > B461



A

End mill High-performance machining

PM-4H

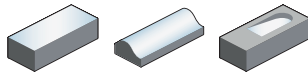

- Factory standard
- Centre cutting
- Helix angle 0°

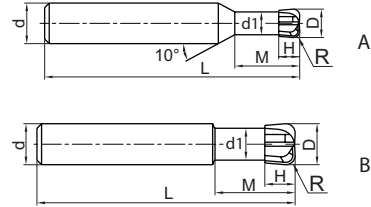

Turning

B

Milling

C

Drilling

Article	*	Dimensions [mm]							Teeth	Geometry	Grade
		D	R	d (h6)	d ₁	H	M	L			
PM-4H-D3.0R0.8		3	0.8	6	2.7	1.2	8	50	4	A	●
PM-4H-D4.0R1.0		4	1	6	3.6	1.6	10	50	4	A	●
PM-4H-D5.0R1.2		5	1.2	6	4.5	2	12.5	50	4	A	●
PM-4H-D6.0R1.0		6	1	6	5.4	2.5	12	50	4	B	●
PM-4H-D6.0R1.5		6	1.5	6	5.4	2.5	12	50	4	B	●
PM-4H-D6.0R2.0		6	2	6	5.4	2.5	12	50	4	B	●
PM-4H-D8.0R1.0		8	1	8	7	3.5	16	60	4	B	●
PM-4H-D8.0R2.0		8	2	8	7	3.5	16	60	4	B	●
PM-4H-D10.0R1.0		10	1	10	9	4	20	75	4	B	●
PM-4H-D10.0R2.0		10	2	10	9	4	20	75	4	B	●
PM-4H-D10.0R3.0		10	3	10	9	4	20	75	4	B	●
PM-4H-D12.0R2.0		12	2	12	11	5	24	75	4	B	●
PM-4H-D12.0R3.0		12	3	12	11	5	24	75	4	B	●

● Ex stock ○ On demand

* With internal cooling

D

Technical Information

E

Index

Application field

P	M	K	N	S	H
✓	✓	✓			✓

✓ Very suitable

✓ Suitable

System code > B258

Cutting data > B422

Nonstandard order > B461

End mill long shank **High-performance machining**

PM-4HL

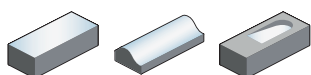

- Factory standard
- Centre cutting
- Helix angle 0°

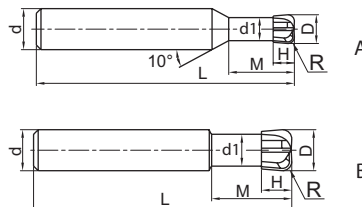

Article	*	Dimensions [mm]							Teeth	Geometry	Grade
		D	R	d (h6)	d ₁	H	M	L			KMG405
PM-4HL-D4.0R1.0		4	1	6	3.6	1.6	10	75	4	A	●
PM-4HL-D5.0R1.2		5	1.2	6	4.5	2	12.5	75	4	A	●
PM-4HL-D6.0R1.0		6	1	6	5.4	2.5	12	75	4	B	●
PM-4HL-D6.0R1.5		6	1.5	6	5.4	2.5	12	75	4	B	●
PM-4HL-D6.0R2.0		6	2	6	5.4	2.5	12	75	4	B	●
PM-4HL-D8.0R1.0		8	1	8	7	3.5	16	100	4	B	●
PM-4HL-D8.0R2.0		8	2	8	7	3.5	16	100	4	B	●
PM-4HL-D10.0R1.0		10	1	10	9	4	20	100	4	B	●
PM-4HL-D10.0R2.0		10	2	10	9	4	20	100	4	B	●
PM-4HL-D10.0R3.0		10	3	10	9	4	20	100	4	B	●
PM-4HL-D12.0R2.0		12	2	12	11	5	24	100	4	B	●
PM-4HL-D12.0R3.0		12	3	12	11	5	24	100	4	B	●

● Ex stock ○ On demand

* With internal cooling

Application field					
P	M	K	N	S	H
✓	✓	✓			✓

✓ Very suitable

✓ Suitable

System code > B258

Cutting data > B422

Nonstandard order > B461



A

Turning

Torus mill High-performance machining

PM-4R

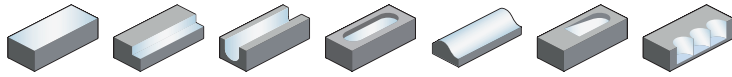

- Factory standard
- Centre cutting
- Helix angle 30°

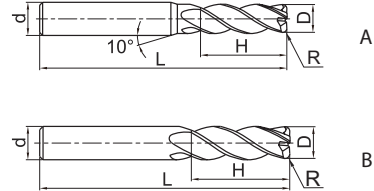

B

Milling

Article	*	Dimensions [mm]					Teeth	Geometry	Grade
		D	R	d (h6)	H	L			
PM-4R-D3.0R0.2		3	0.2	6	8	50	4	A	●
PM-4R-D4.0R0.3		4	0.3	6	10	50	4	A	●
PM-4R-D4.0R0.5		4	0.5	6	10	50	4	A	●
PM-4R-D5.0R0.5		5	0.5	6	13	50	4	A	●
PM-4R-D5.0R1.0		5	1	6	13	50	4	A	●
PM-4R-D6.0R0.5		6	0.5	6	16	50	4	B	●
PM-4R-D6.0R1.0		6	1	6	16	50	4	B	●
PM-4R-D8.0R0.5		8	0.5	8	20	60	4	B	●
PM-4R-D8.0R1.0		8	1	8	20	60	4	B	●
PM-4R-D10.0R0.5		10	0.5	10	25	75	4	B	●
PM-4R-D10.0R1.0		10	1	10	25	75	4	B	●
PM-4R-D10.0R2.0		10	2	10	25	75	4	B	●
PM-4R-D10.0R3.0		10	3	10	25	75	4	B	●
PM-4R-D12.0R0.5		12	0.5	12	30	75	4	B	●
PM-4R-D12.0R1.0		12	1	12	30	75	4	B	●
PM-4R-D12.0R2.0		12	2	12	30	75	4	B	●
PM-4R-D12.0R3.0		12	3	12	30	75	4	B	●

- Ex stock ○ On demand
- * With internal cooling

C

Drilling

D

Technical Information

Application field					
P	M	K	N	S	H
✓	✓	✓			✓

✓ Very suitable
 ✓ Suitable

E

Index



Torus mill long shank

High-performance machining

PM-4RL

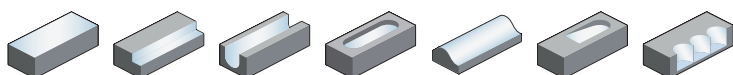

- Factory standard
- Centre cutting
- Helix angle 30°

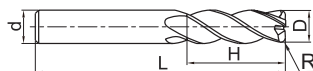

Article	*	Dimensions [mm]					Teeth	Grade
		D	R	d (h6)	H	L		KMG405
PM-4RL-D6.0R0.5		6	0.5	6	16	75	4	●
PM-4RL-D6.0R1.0		6	1	6	16	75	4	●
PM-4RL-D8.0R0.5		8	0.5	8	20	100	4	●
PM-4RL-D8.0R1.0		8	1	8	20	100	4	●
PM-4RL-D10.0R0.5		10	0.5	10	25	100	4	○
PM-4RL-D10.0R1.0		10	1	10	25	100	4	●
PM-4RL-D10.0R2.0		10	2	10	25	100	4	●
PM-4RL-D12.0R0.5		12	0.5	12	30	100	4	●
PM-4RL-D12.0R1.0		12	1	12	30	100	4	●
PM-4RL-D12.0R2.0		12	2	12	30	100	4	●
PM-4RL-D16.0R1.0		16	1	16	45	150	4	●
PM-4RL-D16.0R2.0		16	2	16	45	150	4	●

● Ex stock ○ On demand

* With internal cooling

Application field

P	M	K	N	S	H
✓	✓	✓			✓

✓ Very suitable

✓ Suitable

System code > B258

Cutting data > B422

Nonstandard order > B461



HM series

For machining of hardened materials

- For machining of steel up to 68 HRC.
- Very stable cutting edge with high stiffness and newest coating technology for high cutting speeds and feed rates.
- End mills, ball nose cutters, torus mills and mini cutters
- Diameter range 0.3–20.0 mm

Application fields for machining of steel

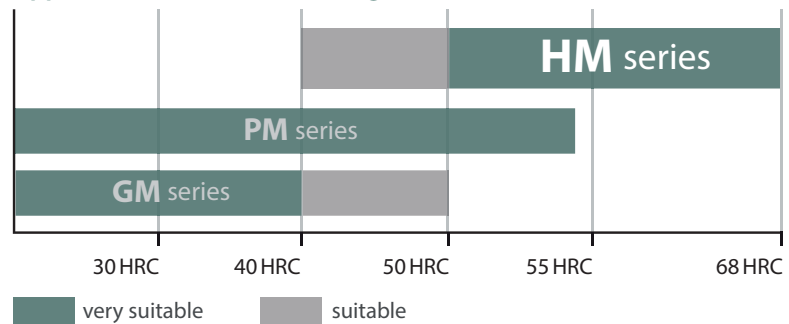

A

End mill

Hard machining

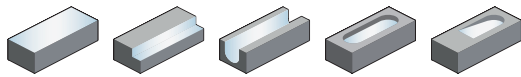

HM-2E

- Factory standard
- Centre cutting
- Helix angle 35°

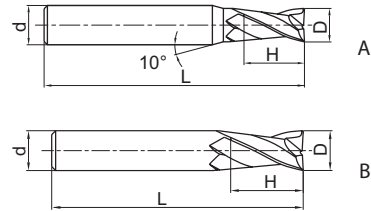

Turning

B

Milling

C

Drilling

D

Technical Information

Article	*	Dimensions [mm]				Teeth	Geometry	Grade
		D	d (h6)	H	L			KMG555
HM-2E-D1.0S		1	4	3	50	2	A	●
HM-2E-D1.5S		1.5	4	4	50	2	A	●
HM-2E-D2.0S		2	4	6	50	2	A	●
HM-2E-D2.5S		2.5	4	8	50	2	A	●
HM-2E-D3.0S		3	4	8	50	2	A	●
HM-2E-D4.0S		4	4	11	50	2	B	●
HM-2E-D1.0		1	6	3	50	2	A	●
HM-2E-D1.5		1.5	6	4	50	2	A	●
HM-2E-D2.0		2	6	6	50	2	A	●
HM-2E-D2.5		2.5	6	8	50	2	A	●
HM-2E-D3.0		3	6	8	50	2	A	●
HM-2E-D3.5		3.5	6	10	50	2	A	●
HM-2E-D4.0		4	6	11	50	2	A	●
HM-2E-D4.5		4.5	6	11	50	2	A	●
HM-2E-D5.0		5	6	13	50	2	A	●
HM-2E-D5.5		5.5	6	16	50	2	A	●
HM-2E-D6.0		6	6	16	50	2	B	●
HM-2E-D7.0		7	8	20	60	2	A	●
HM-2E-D8.0		8	8	20	60	2	B	●
HM-2E-D9.0		9	10	22	75	2	A	●
HM-2E-D10.0		10	10	25	75	2	B	●
HM-2E-D11.0		11	12	26	75	2	A	○
HM-2E-D12.0		12	12	30	75	2	B	●
HM-2E-D14.0		14	14	32	100	2	B	●
HM-2E-D16.0		16	16	45	100	2	B	●
HM-2E-D18.0		18	18	45	100	2	B	○
HM-2E-D20.0		20	20	45	100	2	B	●

● Ex stock ○ On demand

* With internal cooling

E

Application field

P	M	K	N	S	H
					✓

✓ Very suitable

✓ Suitable

Index

System code > B258

Cutting data > B422

Nonstandard order > B461

End mill short cutting edge **Hard machining**

HM-2EFP

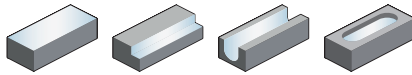

- Factory standard
- Centre cutting
- Helix angle 35°

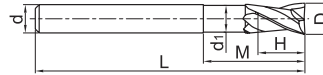

Article	*	Dimensions [mm]						Teeth	Grade
		D	d (h6)	d ₁	H	M	L		KMG555
HM-2EFP-D6.0		6	6	5.8	9	30	75	2	●
HM-2EFP-D8.0		8	8	7.8	12	40	100	2	●
HM-2EFP-D10.0		10	10	9.6	15	50	100	2	●
HM-2EFP-D12.0		12	12	11.5	18	50	100	2	●
HM-2EFP-D16.0		16	16	15.5	24	50	150	2	●
HM-2EFP-D20.0		20	20	19.5	30	60	150	2	●

- Ex stock ○ On demand
- * With internal cooling

Application field					
P	M	K	N	S	H
					✓

- ✓ Very suitable
- ✓ Suitable

A

Turning

B

Milling

C

Drilling

D

Technical Information

E

Index

System code > B258

Cutting data > B422

Nonstandard order > B461



End mill

Hard machining

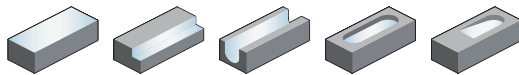

HM-2EP

- Straight shank
- Centre cutting
- Helix angle 35°

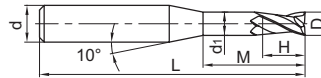

Article	*	Dimensions [mm]						Teeth	Grade
		D	d (h6)	d ₁	H	M	L		KMG555
HM-2EP-D0.5-M04		0.5	4	0.45	0.7	4	50	2	●
HM-2EP-D0.5-M06		0.5	4	0.45	0.7	6	50	2	●
HM-2EP-D0.5-M08		0.5	4	0.45	0.7	8	50	2	●
HM-2EP-D0.8-M04		0.8	4	0.75	1.2	4	50	2	●
HM-2EP-D0.8-M06		0.8	4	0.75	1.2	6	50	2	●
HM-2EP-D0.8-M08		0.8	4	0.75	1.2	8	50	2	●
HM-2EP-D0.8-M10		0.8	4	0.75	1.2	10	50	2	●
HM-2EP-D1.0-M04		1	4	0.95	1.5	4	50	2	●
HM-2EP-D1.0-M06		1	4	0.95	1.5	6	50	2	●
HM-2EP-D1.0-M08		1	4	0.95	1.5	8	50	2	●
HM-2EP-D1.0-M10		1	4	0.95	1.5	10	50	2	●
HM-2EP-D1.0-M12		1	4	0.95	1.5	12	50	2	●
HM-2EP-D1.0-M14		1	4	0.95	1.5	14	50	2	●
HM-2EP-D1.2-M06		1.2	4	1.15	1.8	6	50	2	●
HM-2EP-D1.2-M08		1.2	4	1.15	1.8	8	50	2	●
HM-2EP-D1.2-M10		1.2	4	1.15	1.8	10	50	2	●
HM-2EP-D1.2-M12		1.2	4	1.15	1.8	12	50	2	●
HM-2EP-D1.5-M06		1.5	4	1.45	2.3	6	50	2	●
HM-2EP-D1.5-M08		1.5	4	1.45	2.3	8	50	2	●
HM-2EP-D1.5-M10		1.5	4	1.45	2.3	10	50	2	●
HM-2EP-D1.5-M12		1.5	4	1.45	2.3	12	50	2	●
HM-2EP-D1.5-M14		1.5	4	1.45	2.3	14	50	2	●
HM-2EP-D2.0-M06		2	4	1.95	3	6	50	2	●
HM-2EP-D2.0-M08		2	4	1.95	3	8	50	2	●
HM-2EP-D2.0-M10		2	4	1.95	3	10	50	2	●
HM-2EP-D2.0-M12		2	4	1.95	3	12	50	2	●
HM-2EP-D2.0-M14		2	4	1.95	3	14	50	2	●
HM-2EP-D2.0-M16		2	4	1.95	3	16	50	2	●
HM-2EP-D2.5-M08		2.5	4	2.4	3.7	8	50	2	●
HM-2EP-D2.5-M10		2.5	4	2.4	3.7	10	50	2	●
HM-2EP-D2.5-M12		2.5	4	2.4	3.7	12	50	2	●
HM-2EP-D2.5-M14		2.5	4	2.4	3.7	14	50	2	●
HM-2EP-D2.5-M16		2.5	4	2.4	3.7	16	60	2	●
HM-2EP-D2.5-M18		2.5	4	2.4	3.7	18	60	2	●
HM-2EP-D2.5-M20		2.5	4	2.4	3.7	20	60	2	●
HM-2EP-D3.0-M06		3	6	2.85	4.5	6	50	2	●
HM-2EP-D3.0-M08		3	6	2.85	4.5	8	50	2	●

● Ex stock ○ On demand

* With internal cooling

Application field

P	M	K	N	S	H
					✓

✓ Very suitable

✓ Suitable

System code > B258

Cutting data > B422

Nonstandard order > B461

End mill **Hard machining**

HM-2EP

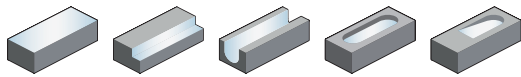

- Straight shank
- Centre cutting
- Helix angle 35°

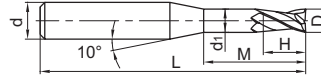

Article	*	Dimensions [mm]						Teeth	Grade
		D	d (h6)	d ₁	H	M	L		KMG555
HM-2EP-D3.0-M10		3	6	2.85	4.5	10	50	2	●
HM-2EP-D3.0-M12		3	6	2.85	4.5	12	50	2	●
HM-2EP-D3.0-M14		3	6	2.85	4.5	14	60	2	●
HM-2EP-D3.0-M16		3	6	2.85	4.5	16	60	2	●
HM-2EP-D3.0-M18		3	6	2.85	4.5	18	60	2	●
HM-2EP-D3.0-M20		3	6	2.85	4.5	20	60	2	●
HM-2EP-D4.0-M12		4	6	3.85	6	12	60	2	●
HM-2EP-D4.0-M16		4	6	3.85	6	16	60	2	●
HM-2EP-D4.0-M20		4	6	3.85	6	20	60	2	●
HM-2EP-D4.0-M25		4	6	3.85	6	25	60	2	●
HM-2EP-D5.0-M16		5	6	4.85	7.5	16	60	2	●
HM-2EP-D5.0-M25		5	6	4.85	7.5	25	70	2	●

- Ex stock ○ On demand
- * With internal cooling

Application field					
P	M	K	N	S	H
					✓

- ✓ Very suitable
- ✓ Suitable

End mill

Hard machining

HM-2ES

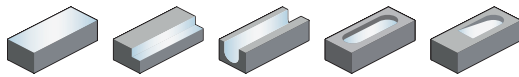

- Factory standard
- Centre cutting
- Helix angle 35°

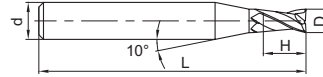

Article	*	Dimensions [mm]				Teeth	Grade
		D	d (h6)	H	L		KMG555
HM-2ES-D0.3		0.3	4	0.6	50	2	●
HM-2ES-D0.4		0.4	4	0.8	50	2	●
HM-2ES-D0.5		0.5	4	1	50	2	●
HM-2ES-D0.6		0.6	4	1.2	50	2	●
HM-2ES-D0.7		0.7	4	1.4	50	2	●
HM-2ES-D0.8		0.8	4	1.6	50	2	●
HM-2ES-D0.9		0.9	4	1.8	50	2	●
HM-2ES-D1.0		1	4	2	50	2	●
HM-2ES-D1.1		1.1	4	2	50	2	●
HM-2ES-D1.2		1.2	4	2.5	50	2	●
HM-2ES-D1.3		1.3	4	2.5	50	2	●
HM-2ES-D1.4		1.4	4	3	50	2	●
HM-2ES-D1.5		1.5	4	3	50	2	●
HM-2ES-D1.6		1.6	4	3.5	50	2	●
HM-2ES-D1.7		1.7	4	3.5	50	2	●
HM-2ES-D1.8		1.8	4	4	50	2	●
HM-2ES-D1.9		1.9	4	4	50	2	●
HM-2ES-D2.0		2	4	4	50	2	●
HM-2ES-D2.1		2.1	4	4	50	2	●
HM-2ES-D2.2		2.2	4	4.5	50	2	●
HM-2ES-D2.3		2.3	4	4.5	50	2	●
HM-2ES-D2.4		2.4	4	5	50	2	●
HM-2ES-D2.5		2.5	4	5	50	2	●
HM-2ES-D2.6		2.6	4	5	50	2	●
HM-2ES-D2.7		2.7	4	5.5	50	2	●
HM-2ES-D2.8		2.8	4	5.5	50	2	●
HM-2ES-D2.9		2.9	4	6	50	2	●
HM-2ES-D3.0		3	4	6	50	2	●

● Ex stock ○ On demand

* With internal cooling

Application field

P	M	K	N	S	H
					✓

✓ Very suitable

✓ Suitable

System code > B258

Cutting data > B422

Nonstandard order > B461

End mill **Hard machining**

HM-4E

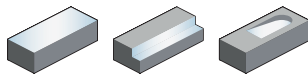

- Factory standard
- Centre cutting
- Helix angle 45°

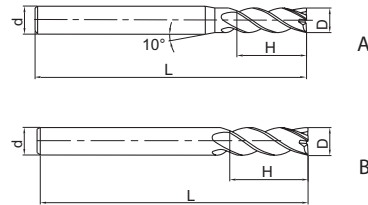

Article	*	Dimensions [mm]				Teeth	Geometry	Grade
		D	d (h6)	H	L			KMG555
HM-4E-D1.0S		1	4	3	50	4	A	●
HM-4E-D1.5S		1.5	4	4	50	4	A	●
HM-4E-D2.0S		2	4	6	50	4	A	●
HM-4E-D2.5S		2.5	4	8	50	4	A	●
HM-4E-D3.0S		3	4	8	50	4	A	●
HM-4E-D4.0S		4	4	11	50	4	B	●
HM-4E-D1.0		1	6	3	50	4	A	●
HM-4E-D1.5		1.5	6	4	50	4	A	●
HM-4E-D2.0		2	6	6	50	4	A	●
HM-4E-D2.5		2.5	6	8	50	4	A	●
HM-4E-D3.0		3	6	8	50	4	A	●
HM-4E-D3.5		3.5	6	10	50	4	A	●
HM-4E-D4.0		4	6	11	50	4	A	●
HM-4E-D4.5		4.5	6	11	50	4	A	●
HM-4E-D5.0		5	6	13	50	4	A	●
HM-4E-D5.5		5.5	6	16	50	4	A	●
HM-4E-D6.0		6	6	16	50	4	B	●
HM-4E-D7.0		7	8	20	60	4	A	●
HM-4E-D8.0		8	8	20	60	4	B	●
HM-4E-D9.0		9	10	22	75	4	A	●
HM-4E-D10.0		10	10	25	75	4	B	●
HM-4E-D11.0		11	12	26	75	4	A	●
HM-4E-D12.0		12	12	30	75	4	B	●
HM-4E-D14.0		14	14	32	75	4	B	●
HM-4E-D16.0		16	16	45	100	4	B	●
HM-4E-D18.0		18	18	45	100	4	B	●
HM-4E-D20.0		20	20	45	100	4	B	●

● Ex stock ○ On demand

* With internal cooling

Application field					
P	M	K	N	S	H
					✓

✓ Very suitable

✓ Suitable

System code > B258

Cutting data > B422

Nonstandard order > B461



A

End mill long shank Hard machining

HM-4EL

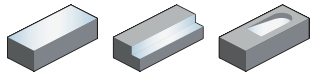

- Factory standard
- Centre cutting
- Helix angle 45°

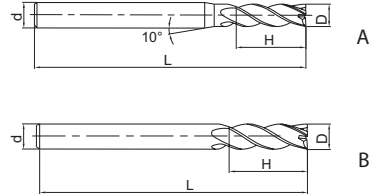

Turning

B

Milling

Article	*	Dimensions [mm]				Teeth	Geometry	Grade
		D	d (h6)	H	L			KMG555
HM-4EL-D3.0		3	6	12	75	4	A	●
HM-4EL-D4.0		4	6	15	75	4	A	●
HM-4EL-D5.0		5	6	20	75	4	A	●
HM-4EL-D6.0		6	6	20	75	4	B	●
HM-4EL-D8.0		8	8	25	100	4	B	●
HM-4EL-D10.0		10	10	30	100	4	B	●
HM-4EL-D12.0		12	12	35	100	4	B	●
HM-4EL-D14.0		14	14	40	100	4	B	●
HM-4EL-D16.0		16	16	50	150	4	B	●
HM-4EL-D20.0		20	20	55	150	4	B	●

● Ex stock ○ On demand

* With internal cooling

C

Drilling

Application field

P	M	K	N	S	H
					✓

✓ Very suitable

✓ Suitable

D

Technical Information

E

Index

System code > B258

Cutting data > B422

Nonstandard order > B461

End mill short cutting edge **Hard machining**

HM-4EFP

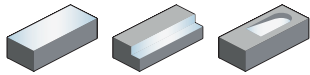

- Factory standard
- Centre cutting
- Helix angle 45°

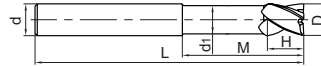

Article	*	Dimensions [mm]						Teeth	Grade
		D	d (h6)	d ₁	H	M	L		KMG555
HM-4EFP-D6.0		6	6	5.8	9	30	75	4	●
HM-4EFP-D8.0		8	8	7.8	12	40	100	4	●
HM-4EFP-D10.0		10	10	9.6	15	50	100	4	●
HM-4EFP-D12.0		12	12	11.5	18	50	100	4	●
HM-4EFP-D16.0		16	16	15.5	24	50	150	4	●
HM-4EFP-D20.0		20	20	19.5	30	60	150	4	○

- Ex stock ○ On demand
- * With internal cooling

Application field					
P	M	K	N	S	H
					✓

- ✓ Very suitable
- ✓ Suitable

A

Turning

B

Milling

C

Drilling

D

Technical Information

E

Index

System code > B258

Cutting data > B422

Nonstandard order > B461



End mill long cutting edge

High-speed hard machining

5502R55MHH

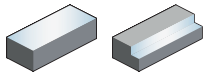

- Type of shank DIN 6535HA
- Non-centre cutting
- Helix angle 55°

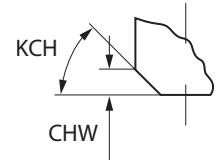
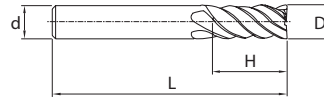

Article	*	Dimensions [mm]						Teeth	Grade
		D	d (h6)	H	L	KCH	CHW		KMG555
5502R55MHH-0300		3	6	8	57	0	0	4	●
5502R55MHH-0400		4	6	11	57	0	0	4	●
5502R55MHH-0500		5	6	13	57	0	0	5	●
5502R55MHH-0600		6	6	13	57	45	0,10	6	●
5502R55MHH-0800		8	8	19	63	45	0,10	6	●
5502R55MHH-1000		10	10	22	72	45	0,10	6	●
5502R55MHH-1200		12	12	26	83	45	0,10	6	●
5502R55MHH-1600		16	16	32	92	45	0,10	6	●
5502R55MHH-2000		20	20	38	104	45	0,10	8	●

- Ex stock ○ On demand
- * With internal cooling

Application field

P	M	K	N	S	H
					✓

- ✓ Very suitable
- ✓ Suitable

A

Turning

B

Milling

C

Drilling

D

Technical Information

E

Index

System code > B258

Cutting data > B422

Nonstandard order > B461

End mill **Hard machining**

HM-6E

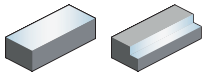

- Factory standard
- Non-centre cutting
- Helix angle 45°

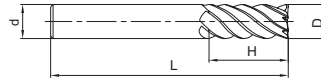

Article	*	Dimensions [mm]				Teeth	Grade
		D	d (h6)	H	L		KMG555
HM-6E-D6.0		6	6	18	60	6	●
HM-6E-D8.0		8	8	20	60	6	●
HM-6E-D10.0		10	10	30	75	6	●
HM-6E-D12.0		12	12	32	75	6	●
HM-6E-D16.0		16	16	40	100	6	●
HM-6E-D20.0		20	20	45	100	6	●

- Ex stock ○ On demand
- * With internal cooling

Application field					
P	M	K	N	S	H
					✓

- ✓ Very suitable
- ✓ Suitable

A

Turning

B

Milling

C

Drilling

D

Technical Information

E

Index

A

End mill long shank

Hard machining

Turning

HM-6EL

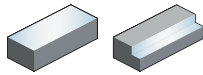

- Factory standard
- Non-centre cutting
- Helix angle 45°

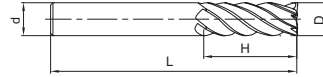

B

Milling

Article	*	Dimensions [mm]				Teeth	Grade
		D	d (h6)	H	L		KMG555
HM-6EL-D6.0		6	6	24	75	6	●
HM-6EL-D8.0		8	8	32	75	6	●
HM-6EL-D10.0		10	10	40	100	6	●
HM-6EL-D12.0		12	12	45	100	6	●
HM-6EL-D16.0		16	16	64	150	6	●
HM-6EL-D20.0		20	20	75	150	6	●

- Ex stock ○ On demand
- * With internal cooling

C

Drilling

Application field

P	M	K	N	S	H
					✓

- ✓ Very suitable
- ✓ Suitable

D

Technical Information

E

Index

System code > B258

Cutting data > B422

Nonstandard order > B461

Ball nose cutter **Hard machining**

HM-2B

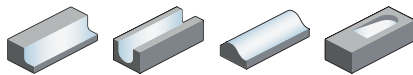

- Factory standard
- Centre cutting
- Helix angle 35°

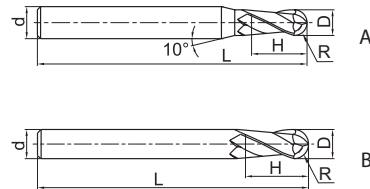

Article	*	Dimensions [mm]					Teeth	Geometry	Grade
		D	R	d (h6)	H	L			KMG555
HM-2B-R0.5S		1	0.5	4	2	50	2	A	●
HM-2B-R0.75S		1.5	0.75	4	3	50	2	A	●
HM-2B-R1.0S		2	1	4	4	50	2	A	●
HM-2B-R1.25S		2.5	1.25	4	5	50	2	A	●
HM-2B-R1.5S		3	1.5	4	6	50	2	A	●
HM-2B-R2.0S		4	2	4	8	50	2	B	●
HM-2B-R0.5		1	0.5	6	2	50	2	A	●
HM-2B-R0.75		1.5	0.75	6	3	50	2	A	●
HM-2B-R1.0		2	1	6	4	50	2	A	●
HM-2B-R1.25		2.5	1.25	6	5	50	2	A	●
HM-2B-R1.5		3	1.5	6	6	50	2	A	●
HM-2B-R1.75		3.5	1.75	6	8	50	2	A	●
HM-2B-R2.0		4	2	6	8	50	2	A	●
HM-2B-R2.5		5	2.5	6	10	50	2	A	●
HM-2B-R2.75		5.5	2.75	6	12	50	2	A	●
HM-2B-R3.0		6	3	6	12	50	2	B	●
HM-2B-R3.5		7	3.5	8	14	60	2	A	●
HM-2B-R4.0		8	4	8	16	60	2	B	●
HM-2B-R4.5		9	4.5	10	18	75	2	A	●
HM-2B-R5.0		10	5	10	20	75	2	B	●
HM-2B-R6.0		12	6	12	24	75	2	B	●
HM-2B-R7.0		14	7	14	28	75	2	B	●
HM-2B-R8.0		16	8	16	32	100	2	B	●
HM-2B-R10.0		20	10	20	40	100	2	B	●

● Ex stock ○ On demand

* With internal cooling

Application field					
P	M	K	N	S	H
					✓

✓ Very suitable

✓ Suitable

System code > B258

Cutting data > B422

Nonstandard order > B461



A

Ball nose cutter long shank Hard machining

HM-2BL

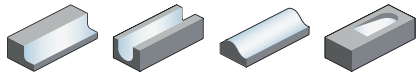

- Factory standard
- Centre cutting
- Helix angle 35°

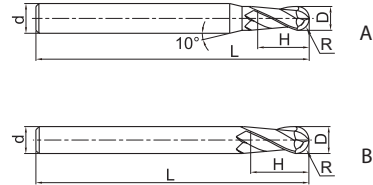

Turning

B

Milling

Article	*	Dimensions [mm]					Teeth	Geometry	Grade
		D	R	d (h6)	H	L			KMG555
HM-2BL-R1.0		2	1	6	4	75	2	A	●
HM-2BL-R1.25		2.5	1.25	6	6	75	2	A	●
HM-2BL-R1.5		3	1.5	6	6	75	2	A	●
HM-2BL-R1.75		3.5	1.75	6	8	75	2	A	●
HM-2BL-R2.0		4	2	6	8	75	2	A	●
HM-2BL-R2.5		5	2.5	6	10	75	2	A	●
HM-2BL-R2.75		5.5	2.75	6	12	75	2	A	●
HM-2BL-R3.0		6	3	6	12	75	2	B	●
HM-2BL-R3.5		7	3.5	8	14	75	2	A	●
HM-2BL-R4.0		8	4	8	16	100	2	B	●
HM-2BL-R4.5		9	4.5	10	18	100	2	A	●
HM-2BL-R5.0		10	5	10	20	100	2	B	●
HM-2BL-R6.0		12	6	12	24	100	2	B	●
HM-2BL-R7.0		14	7	14	28	100	2	B	●
HM-2BL-R8.0		16	8	16	32	150	2	B	●
HM-2BL-R10.0		20	10	20	40	150	2	B	●

● Ex stock ○ On demand

* With internal cooling

C

Drilling

D

Technical Information

Application field

P	M	K	N	S	H
					✓

- ✓ Very suitable
- ✓ Suitable

E

Index

System code > B258

Cutting data > B422

Nonstandard order > B461

Ball nose cutter short cutting edge **Hard machining**

HM-2BFP

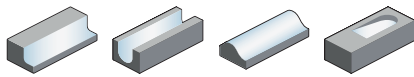

- Factory standard
- Centre cutting
- Helix angle 35°

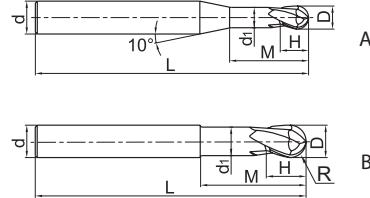

Article	*	Dimensions [mm]							Teeth	Geometry	Grade
		D	R	d (h6)	d ₁	H	M	L			KMG555
HM-2BFP-R0.5		1	0.5	6	0.95	1	2.5	75	2	A	●
HM-2BFP-R0.75		1.5	0.75	6	1.45	1.5	3	75	2	A	●
HM-2BFP-R1.0		2	1	6	1.95	2	4	75	2	A	●
HM-2BFP-R1.5		3	1.5	6	2.85	3	6	75	2	A	●
HM-2BFP-R2.0		4	2	6	3.85	4	8	75	2	A	●
HM-2BFP-R2.5		5	2.5	6	4.85	5	10	75	2	A	●
HM-2BFP-R3.0		6	3	6	5.8	6	12	75	2	B	●
HM-2BFP-R4.0		8	4	8	7.8	8	16	100	2	B	●
HM-2BFP-R5.0		10	5	10	9.6	10	20	100	2	B	●
HM-2BFP-R6.0		12	6	12	11.5	12	24	100	2	B	●
HM-2BFP-R8.0		16	8	16	15.5	16	32	150	2	B	●
HM-2BFP-R10.0		20	10	20	19.5	20	40	150	2	B	●

- Ex stock ○ On demand
- * With internal cooling

Application field					
P	M	K	N	S	H
					✓

- ✓ Very suitable
- ✓ Suitable

A

Ball nose cutter

Hard machining

Turning

HM-2BS

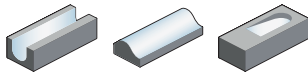

- Factory standard
- Centre cutting
- Helix angle 35°

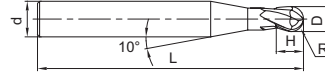

B

Milling

Article	*	Dimensions [mm]					Teeth	Grade
		D	R	d (h6)	H	L		KMG555
HM-2BS-R0.15		0.3	0.15	4	0.5	50	2	●
HM-2BS-R0.20		0.4	0.2	4	0.6	50	2	●
HM-2BS-R0.25		0.5	0.25	4	0.8	50	2	●
HM-2BS-R0.30		0.6	0.3	4	0.9	50	2	●
HM-2BS-R0.35		0.7	0.35	4	1	50	2	●
HM-2BS-R0.40		0.8	0.4	4	1.2	50	2	●
HM-2BS-R0.45		0.9	0.45	4	1.3	50	2	●
HM-2BS-R0.50		1	0.5	4	1.5	50	2	●
HM-2BS-R0.60		1.2	0.6	4	1.8	50	2	●
HM-2BS-R0.70		1.4	0.7	4	2	50	2	●
HM-2BS-R0.75		1.5	0.75	4	2.3	50	2	●
HM-2BS-R0.80		1.6	0.8	4	2.5	50	2	●
HM-2BS-R0.90		1.8	0.9	4	2.7	50	2	●
HM-2BS-R1.00		2	1	4	3	50	2	●
HM-2BS-R1.25		2.5	1.25	4	3.7	50	2	●
HM-2BS-R1.50		3	1.5	4	4.5	50	2	●

● Ex stock ○ On demand

* With internal cooling

C

Drilling

D

Technical Information

E

Index

Application field

P	M	K	N	S	H
					✓

✓ Very suitable

✓ Suitable

System code > B258

Cutting data > B422

Nonstandard order > B461

End mill **Hard machining**

HM-2BP

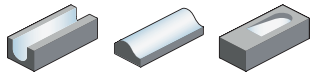

- Straight shank
- Centre cutting
- Helix angle 35°

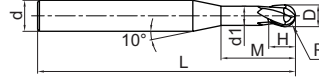

Article	*	Dimensions [mm]							Teeth	Grade	
		D	R	d (h6)	d ₁	H	M	L		KMG555	
HM-2BP-R0.25-M04		0.5	0.25	4	0.45	0.7	4	50	2	●	
HM-2BP-R0.25-M06		0.5	0.25	4	0.45	0.7	6	50	2	●	
HM-2BP-R0.3-M04		0.6	0.3	4	0.55	0.9	4	50	2	●	
HM-2BP-R0.3-M06		0.6	0.3	4	0.55	0.9	6	50	2	●	
HM-2BP-R0.3-M08		0.6	0.3	4	0.55	0.9	8	50	2	●	
HM-2BP-R0.4-M04		0.8	0.4	4	0.75	1.2	4	50	2	●	
HM-2BP-R0.4-M06		0.8	0.4	4	0.75	1.2	6	50	2	●	
HM-2BP-R0.4-M08		0.8	0.4	4	0.75	1.2	8	50	2	●	
HM-2BP-R0.4-M10		0.8	0.4	4	0.75	1.2	10	50	2	●	
HM-2BP-R0.5-M04		1	0.5	4	0.95	1.5	4	50	2	●	
HM-2BP-R0.5-M06		1	0.5	4	0.95	1.5	6	50	2	●	
HM-2BP-R0.5-M08		1	0.5	4	0.95	1.5	8	50	2	●	
HM-2BP-R0.5-M10		1	0.5	4	0.95	1.5	10	50	2	●	
HM-2BP-R0.5-M12		1	0.5	4	0.95	1.5	12	50	2	●	
HM-2BP-R0.6-M06		1.2	0.6	4	1.15	1.8	6	50	2	●	
HM-2BP-R0.6-M08		1.2	0.6	4	1.15	1.8	8	50	2	●	
HM-2BP-R0.6-M12		1.2	0.6	4	1.15	1.8	12	50	2	●	
HM-2BP-R0.6-M16		1.2	0.6	4	1.15	1.8	16	50	2	●	
HM-2BP-R0.75-M08		1.5	0.75	4	1.45	2.3	8	50	2	●	
HM-2BP-R0.75-M12		1.5	0.75	4	1.45	2.3	12	50	2	●	
HM-2BP-R0.75-M16		1.5	0.75	4	1.45	2.3	16	50	2	●	
HM-2BP-R1.0-M06		2	1	4	1.95	3	6	50	2	●	
HM-2BP-R1.0-M08		2	1	4	1.95	3	8	50	2	●	
HM-2BP-R1.0-M10		2	1	4	1.95	3	10	50	2	●	
HM-2BP-R1.0-M12		2	1	4	1.95	3	12	50	2	●	
HM-2BP-R1.0-M16		2	1	4	1.95	3	16	50	2	●	
HM-2BP-R1.0-M20		2	1	4	1.95	3	20	50	2	●	
HM-2BP-R1.25-M08		2.5	1.25	4	2.4	3.7	8	50	2	●	
HM-2BP-R1.25-M12		2.5	1.25	4	2.4	3.7	12	50	2	●	
HM-2BP-R1.25-M16		2.5	1.25	4	2.4	3.7	16	60	2	●	
HM-2BP-R1.25-M20		2.5	1.25	4	2.4	3.7	20	60	2	●	
HM-2BP-R1.5-M08		3	1.5	6	2.85	4.5	8	50	2	●	
HM-2BP-R1.5-M10		3	1.5	6	2.85	4.5	10	50	2	●	
HM-2BP-R1.5-M12		3	1.5	6	2.85	4.5	12	50	2	●	
HM-2BP-R1.5-M16		3	1.5	6	2.85	4.5	16	60	2	●	
HM-2BP-R1.5-M20		3	1.5	6	2.85	4.5	20	60	2	●	
HM-2BP-R2.0-M10		4	2	6	3.85	6	10	60	2	●	

● Ex stock ○ On demand

* With internal cooling

Application field					
P	M	K	N	S	H
					✓

✓ Very suitable

✓ Suitable

System code > B258

Cutting data > B422

Nonstandard order > B461



A

Turning

B

Milling

C

Drilling

D

Technical Information

E

Index

A

End mill

Hard machining

Turning

HM-2BP

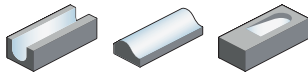

- Straight shank
- Centre cutting
- Helix angle 35°

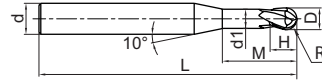

B

Milling

Article	*	Dimensions [mm]							Teeth	Grade
		D	R	d (h6)	d ₁	H	M	L		KMG555
HM-2BP-R2.0-M16	*	4	2	6	3.85	6	16	60	2	●
HM-2BP-R2.0-M20	*	4	2	6	3.85	6	20	60	2	●
HM-2BP-R2.0-M25	*	4	2	6	3.85	6	25	60	2	●
HM-2BP-R2.5-M16	*	5	2.5	6	4.85	7.5	16	60	2	●
HM-2BP-R2.5-M25	*	5	2.5	6	4.85	7.5	25	70	2	●

● Ex stock ○ On demand

* With internal cooling

C

Drilling

Application field

P	M	K	N	S	H
					✓

✓ Very suitable

✓ Suitable

D

Technical Information

E

Index

System code > B258

Cutting data > B422

Nonstandard order > B461

Ball nose cutter **Hard machining**

HM-4B

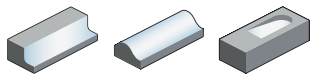

- Factory standard
- Centre cutting
- Helix angle 35°

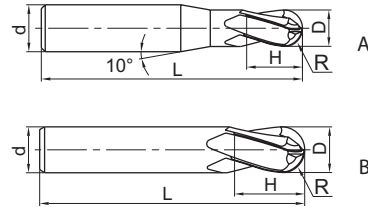

Article	*	Dimensions [mm]					Teeth	Geometry	Grade
		D	R	d (h6)	H	L			KMG555
HM-4B-R1.5		3	1.5	6	6	50	4	A	●
HM-4B-R2.0		4	2	6	8	50	4	A	●
HM-4B-R2.5		5	2.5	6	10	50	4	A	●
HM-4B-R3.0		6	3	6	12	50	4	B	●
HM-4B-R4.0		8	4	8	16	60	4	B	●
HM-4B-R5.0		10	5	10	20	75	4	B	●
HM-4B-R6.0		12	6	12	24	75	4	B	●
HM-4B-R7.0		14	7	14	28	75	4	B	●
HM-4B-R8.0		16	8	16	32	100	4	B	●
HM-4B-R9.0		18	9	18	36	100	4	B	●
HM-4B-R10.0		20	10	20	40	100	4	B	●

- Ex stock ○ On demand
- * With internal cooling

Application field					
P	M	K	N	S	H
					✓

- ✓ Very suitable
- ✓ Suitable



A

Turning

B

Milling

C

Drilling

D

Technical Information

E

Index

A

Ball nose cutter long shank Hard machining

HM-4BL

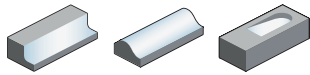

- Factory standard
- Centre cutting
- Helix angle 35°

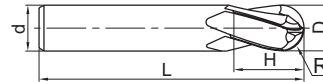
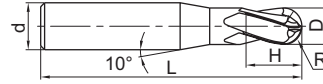

Turning

B

Article	*	Dimensions [mm]					Teeth	Geometry	Grade
		D	R	d (h6)	H	L			KMG555
HM-4BL-R1.5		3	1.5	6	6	75	4	A	●
HM-4BL-R2.0		4	2	6	8	75	4	A	●
HM-4BL-R2.5		5	2.5	6	10	75	4	A	●
HM-4BL-R3.0		6	3	6	12	75	4	B	●
HM-4BL-R4.0		8	4	8	16	100	4	B	●
HM-4BL-R5.0		10	5	10	20	100	4	B	●
HM-4BL-R6.0		12	6	12	24	100	4	B	●
HM-4BL-R7.0		14	7	14	28	100	4	B	●
HM-4BL-R8.0		16	8	16	32	150	4	B	●
HM-4BL-R9.0		18	9	18	36	150	4	B	●
HM-4BL-R10.0		20	10	20	40	150	4	B	●

Milling

C

- Ex stock ○ On demand
- * With internal cooling

Drilling

Application field

P	M	K	N	S	H
					✓

- ✓ Very suitable
- ✓ Suitable

D

Technical Information

E

Index

System code > B258

Cutting data > B422

Nonstandard order > B461

Torus mill

Hard machining

HM-4R

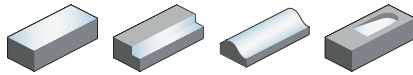

- Factory standard
- Centre cutting
- Helix angle 35°

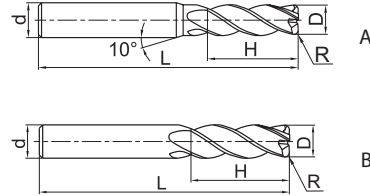

Article	*	Dimensions [mm]					Teeth	Geometry	Grade
		D	R	d (h6)	H	L			KMG555
HM-4R-D3.0R0.2		3	0.2	4	8	50	4	A	●
HM-4R-D4.0R0.3		4	0.3	4	10	50	4	B	●
HM-4R-D4.0R0.5		4	0.5	4	10	50	4	B	●
HM-4R-D5.0R0.5		5	0.5	6	13	50	4	A	●
HM-4R-D5.0R1.0		5	1	6	13	50	4	A	●
HM-4R-D6.0R0.5		6	0.5	6	16	50	4	B	●
HM-4R-D6.0R1.0		6	1	6	16	50	4	B	●
HM-4R-D8.0R0.5		8	0.5	8	20	60	4	B	●
HM-4R-D8.0R1.0		8	1	8	20	60	4	B	●
HM-4R-D10.0R0.5		10	0.5	10	25	75	4	B	●
HM-4R-D10.0R1.0		10	1	10	25	75	4	B	●
HM-4R-D10.0R2.0		10	2	10	25	75	4	B	●
HM-4R-D10.0R3.0		10	3	10	25	75	4	B	●
HM-4R-D12.0R0.5		12	0.5	12	30	75	4	B	●
HM-4R-D12.0R1.0		12	1	12	30	75	4	B	●
HM-4R-D12.0R2.0		12	2	12	30	75	4	B	●
HM-4R-D12.0R3.0		12	3	12	30	75	4	B	●

- Ex stock ○ On demand
- * With internal cooling

Application field					
P	M	K	N	S	H
					✓

- ✓ Very suitable
- ✓ Suitable

A

Torus mill short cutting edge Hard machining

Turning

HM-4RF

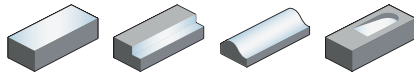

- Factory standard
- Centre cutting
- Helix angle 35°

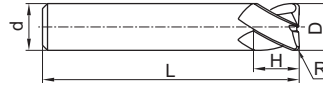

B

Milling

Article	*	Dimensions [mm]					Teeth	Grade
		D	R	d (h6)	H	L		KMG555
HM-4RF-D6.0R0.5		6	0.5	6	6	50	4	○
HM-4RF-D6.0R1.0		6	1	6	6	50	4	○
HM-4RF-D8.0R0.5		8	0.5	8	8	60	4	○
HM-4RF-D8.0R1.0		8	1	8	8	60	4	○
HM-4RF-10.0R0.5		10	0.5	10	10	75	4	●
HM-4RF-D10.0R1.0		10	1	10	10	75	4	○
HM-4RF-D10.0R2.0		10	2	10	10	75	4	○
HM-4RF-D12.0R0.5		12	0.5	12	12	75	4	○
HM-4RF-D12.0R1.0		12	1	12	12	75	4	○
HM-4RF-D12.0R2.0		12	2	12	12	75	4	○

- Ex stock ○ On demand
- * With internal cooling

C

Drilling

Application field

P	M	K	N	S	H
					✓

- ✓ Very suitable
- ✓ Suitable

D

Technical Information

E

Index

System code > B258

Cutting data > B422

Nonstandard order > B461

Torus mill long shank Hard machining

HM-4RP

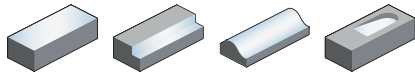

- Factory standard
- Centre cutting
- Helix angle 35°

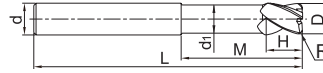

Article	*	Dimensions [mm]							Teeth	Grade
		D	R	d (h6)	d ₁	H	M	L		KMG555
HM-4RP-D6.0R0.5		6	0.5	6	5.8	6	18	75	4	●
HM-4RP-D6.0R1.0		6	1	6	5.8	6	18	75	4	●
HM-4RP-D8.0R0.5		8	0.5	8	7.8	8	24	100	4	●
HM-4RP-D8.0R1.0		8	1	8	7.8	8	24	100	4	●
HM-4RP-D10.0R0.5		10	0.5	10	9.6	10	30	100	4	●
HM-4RP-D10.0R1.0		10	1	10	9.6	10	30	100	4	●
HM-4RP-D10.0R2.0		10	2	10	9.6	10	30	100	4	●
HM-4RP-D12.0R0.5		12	0.5	12	11.5	12	36	100	4	●
HM-4RP-D12.0R1.0		12	1	12	11.5	12	36	100	4	●
HM-4RP-D12.0R2.0		12	2	12	11.5	12	36	100	4	●
HM-4RP-D16.0R1.0		16	1	16	15.5	16	40	150	4	●
HM-4RP-D16.0R2.0		16	2	16	15.5	16	40	150	4	●

- Ex stock ○ On demand
- * With internal cooling

Application field					
P	M	K	N	S	H
					✓

- ✓ Very suitable
- ✓ Suitable

System code > B258

Cutting data > B422

Nonstandard order > B461



NM series

For machining of copper

- For machining of copper and copper alloys (brass, bronze).
- Excellent sharpness of cutting edge for very good surface quality.
- End mills, ball nose cutters and mini cutters.
- Diameter range 0.5–20.0 mm



A

End mill General machining of non-ferrous metals

5502R402NM

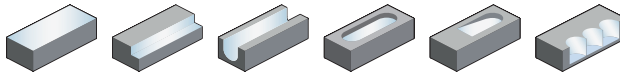

- Type of shank DIN 6535HA
- Centre cutting
- Helix angle 40°

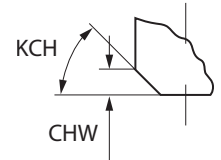
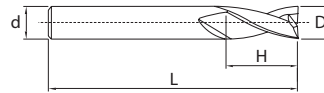

Turning

B

Article	*	Dimensions [mm]						Teeth	Grade
		D	d (h6)	H	L	KCH	CHW		
5502R402NM-0300		3	6	8	57	0	0	2	●
5502R402NM-0400		4	6	11	57	0	0	2	●
5502R402NM-0500		5	6	13	57	0	0	2	●
5502R402NM-0600		6	6	13	57	45	0,10	2	●
5502R402NM-0800		8	8	19	63	45	0,10	2	●
5502R402NM-1000		10	10	22	72	45	0,10	2	●
5502R402NM-1200		12	12	26	83	45	0,10	2	●
5502R402NM-1400		14	14	26	83	45	0,15	2	●
5502R402NM-1600		16	16	32	92	45	0,15	2	●
5502R402NM-1800		18	18	32	92	45	0,15	2	●
5502R402NM-2000		20	20	38	104	45	0,15	2	●

- Ex stock ○ On demand
- * With internal cooling

Milling

C

Application field

P	M	K	N	S	H
			✓		

- ✓ Very suitable
- ✓ Suitable

Drilling

D

Technical Information

E

Index

System code > B258

Cutting data > B422

Nonstandard order > B461

End mill **General machining of non-ferrous metals**

NM-2E

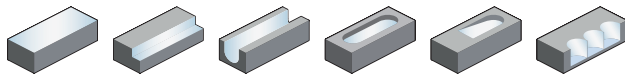

- Factory standard
- Centre cutting
- Helix angle 35°

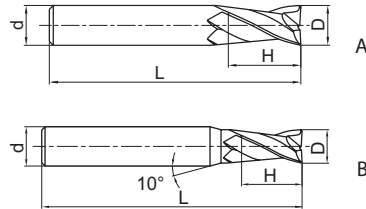

Article	*	Dimensions [mm]				Teeth	Geometry	Grade
		D	d (h6)	H	L			KMG309
NM-2E-D1.0		1	4	3	50	2	A	●
NM-2E-D2.0		2	4	6	50	2	A	●
NM-2E-D3.0		3	6	8	50	2	A	●
NM-2E-D4.0		4	6	11	50	2	A	●
NM-2E-D5.0		5	6	13	50	2	A	●
NM-2E-D6.0		6	6	16	50	2	B	●
NM-2E-D8.0		8	8	20	60	2	B	●
NM-2E-D10.0		10	10	25	75	2	B	●
NM-2E-D12.0		12	12	30	75	2	B	●

- Ex stock ○ On demand
- * With internal cooling

Application field					
P	M	K	N	S	H
			✓		

- ✓ Very suitable
- ✓ Suitable

A

Turning

B

Milling

C

Drilling

D

Technical Information

E

Index

End mill General machining of non-ferrous metals

NM-2EP

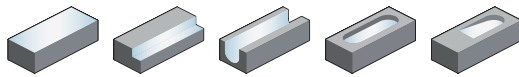

- Factory standard
- Centre cutting
- Helix angle 35°

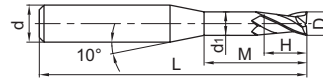

Article	*	Dimensions [mm]						Teeth	Grade
		D	d (h6)	d ₁	H	M	L		KMG309
NM-2EP-D0.5-M08		0.5	4	0.45	0.7	8	50	2	●
NM-2EP-D0.5-M06		0.5	4	0.45	0.7	6	50	2	●
NM-2EP-D0.5-M04		0.5	4	0.45	0.7	4	50	2	●
NM-2EP-D0.8-M08		0.8	4	0.75	1.2	8	50	2	●
NM-2EP-D0.8-M04		0.8	4	0.75	1.2	4	50	2	●
NM-2EP-D0.8-M10		0.8	4	0.75	1.2	10	50	2	●
NM-2EP-D0.8-M06		0.8	4	0.75	1.2	6	50	2	●
NM-2EP-D1.0-M04		1	4	0.95	1.5	4	50	2	●
NM-2EP-D1.0-M10		1	4	0.95	1.5	10	50	2	●
NM-2EP-D1.0-M08		1	4	0.95	1.5	8	50	2	●
NM-2EP-D1.0-M06		1	4	0.95	1.5	6	50	2	●
NM-2EP-D1.0-M14		1	4	0.95	1.5	14	50	2	●
NM-2EP-D1.0-M12		1	4	0.95	1.5	12	50	2	●
NM-2EP-D1.5-M08		1.5	4	1.45	2.3	8	50	2	●
NM-2EP-D1.5-M16		1.5	4	1.45	2.3	16	50	2	●
NM-2EP-D2.0-M14		2	4	1.95	3	14	50	2	●
NM-2EP-D2.0-M08		2	4	1.95	3	8	50	2	●
NM-2EP-D2.0-M06		2	4	1.95	3	6	50	2	●
NM-2EP-D2.0-M10		2	4	1.95	3	10	50	2	●
NM-2EP-D2.0-M12		2	4	1.95	3	12	50	2	●
NM-2EP-D2.0-M16		2	4	1.95	3	16	50	2	●
NM-2EP-D2.5-M10		2.5	4	2.4	3.7	10	50	2	●
NM-2EP-D2.5-M20		2.5	4	2.4	3.7	20	60	2	●
NM-2EP-D3.0-M20		3	6	2.85	4.5	20	60	2	●
NM-2EP-D3.0-M10		3	6	2.85	4.5	10	50	2	●
NM-2EP-D4.0-M16		4	6	3.85	6	16	60	2	●
NM-2EP-D4.0-M25		4	6	3.85	6	25	60	2	●
NM-2EP-D5.0-M16		5	6	4.85	7.5	16	60	2	●
NM-2EP-D5.0-M25		5	6	4.85	7.5	25	70	2	●

● Ex stock ○ On demand

* With internal cooling

Application field

P	M	K	N	S	H
			✓		

✓ Very suitable

✓ Suitable

System code > B258

Cutting data > B422

Nonstandard order > B461

End mill **General machining of non-ferrous metals**

NM-4E

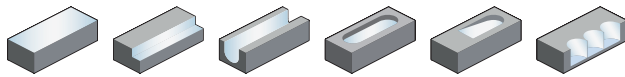

- Factory standard
- Centre cutting
- Helix angle 35°

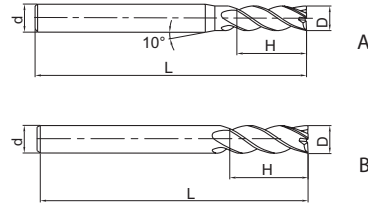

Article	*	Dimensions [mm]				Teeth	Geometry	Grade
		D	d (h6)	H	L			KMG309
NM-4E-D3.0		3	6	8	50	4	A	●
NM-4E-D4.0		4	6	11	50	4	A	●
NM-4E-D5.0		5	6	13	50	4	A	●
NM-4E-D6.0		6	6	16	50	4	B	●
NM-4E-D8.0		8	8	20	60	4	B	●
NM-4E-D10.0		10	10	25	75	4	B	●
NM-4E-D12.0		12	12	30	75	4	B	●

- Ex stock ○ On demand
- * With internal cooling

Application field					
P	M	K	N	S	H
			✓		

- ✓ Very suitable
- ✓ Suitable

A

Ball nose cutter General machining of non-ferrous metals

NM-2B

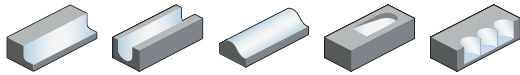

- Factory standard
- Centre cutting
- Helix angle 35°

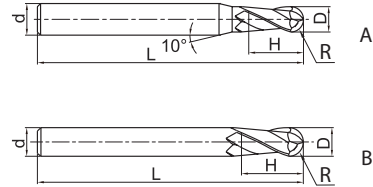

Turning

B

Milling

Article	*	Dimensions [mm]					Teeth	Geometry	Grade
		D	R	d (h6)	H	L			KMG309
NM-2B-R0.5		1	0.5	4	2	50	2	A	●
NM-2B-R0.75		1.5	0.75	4	3	50	2	A	●
NM-2B-R1.0		2	1	4	4	50	2	A	●
NM-2B-R1.25		2.5	1.25	4	5	50	2	A	●
NM-2B-R1.5		3	1.5	6	6	50	2	A	●
NM-2B-R1.75		3.5	1.75	6	8	50	2	A	●
NM-2B-R2.0		4	2	6	8	50	2	A	●
NM-2B-R2.5		5	2.5	6	10	50	2	A	●
NM-2B-R3.0		6	3	6	12	50	2	B	●
NM-2B-R4.0		8	4	8	16	60	2	B	●
NM-2B-R5.0		10	5	10	20	75	2	B	●
NM-2B-R6.0		12	6	12	24	75	2	B	●

- Ex stock ○ On demand
- * With internal cooling

C

Drilling

D

Technical Information

E

Index

Application field

P	M	K	N	S	H
			✓		

- ✓ Very suitable
- ✓ Suitable

System code > B258

Cutting data > B422

Nonstandard order > B461

Ball nose cutter **General machining of non-ferrous metals**

NM-2BP

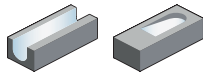

- Factory standard
- Centre cutting
- Helix angle 35°

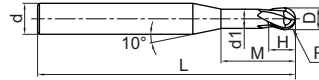

Article	*	Dimensions [mm]							Teeth	Grade
		D	R	d (h6)	d ₁	H	M	L		KMG309
NM-2BP-R0.25-M04		0.5	0.25	4	0.45	0.7	4	50	2	●
NM-2BP-R0.25-M06		0.5	0.25	4	0.45	0.7	6	50	2	●
NM-2BP-R0.3-M04		0.6	0.3	4	0.55	0.9	4	50	2	●
NM-2BP-R0.3-M06		0.6	0.3	4	0.55	0.9	6	50	2	●
NM-2BP-R0.3-M08		0.6	0.3	4	0.55	0.9	8	50	2	●
NM-2BP-R0.4-M04		0.8	0.4	4	0.75	1.2	4	50	2	●
NM-2BP-R0.4-M06		0.8	0.4	4	0.75	1.2	6	50	2	●
NM-2BP-R0.4-M08		0.8	0.4	4	0.75	1.2	8	50	2	●
NM-2BP-R0.4-M10		0.8	0.4	4	0.75	1.2	10	50	2	●
NM-2BP-R0.5-M04		1	0.5	4	0.95	1.5	4	50	2	●
NM-2BP-R0.5-M06		1	0.5	4	0.95	1.5	6	50	2	●
NM-2BP-R0.5-M08		1	0.5	4	0.95	1.5	8	50	2	●
NM-2BP-R0.5-M10		1	0.5	4	0.95	1.5	10	50	2	●
NM-2BP-R0.5-M12		1	0.5	4	0.95	1.5	12	50	2	●
NM-2BP-R0.75-M08		1.5	0.75	4	1.45	2.3	8	50	2	●
NM-2BP-R0.75-M16		1.5	0.75	4	1.45	2.3	16	50	2	●
NM-2BP-R1.0-M06		2	1	4	1.95	3	6	50	2	●
NM-2BP-R1.0-M08		2	1	4	1.95	3	8	50	2	●
NM-2BP-R1.0-M10		2	1	4	1.95	3	10	50	2	●
NM-2BP-R1.0-M12		2	1	4	1.95	3	12	50	2	●
NM-2BP-R1.0-M16		2	1	4	1.95	3	16	50	2	●
NM-2BP-R1.0-M20		2	1	4	1.95	3	20	60	2	●
NM-2BP-R1.5-M10		3	1.5	6	2.85	4.5	10	50	2	●
NM-2BP-R1.5-M20		3	1.5	6	2.85	4.5	20	60	2	●
NM-2BP-R2.0-M10		4	2	6	3.85	6	10	60	2	●
NM-2BP-R2.0-M16		4	2	6	3.85	6	16	60	2	●
NM-2BP-R2.0-M20		4	2	6	3.85	6	20	60	2	●
NM-2BP-R2.0-M25		4	2	6	3.85	6	25	60	2	●
NM-2BP-R2.5-M16		5	2.5	6	4.85	7.5	16	60	2	●
NM-2BP-R2.5-M25		5	2.5	6	4.85	7.5	25	70	2	●

- Ex stock ○ On demand
- * With internal cooling

Application field					
P	M	K	N	S	H
			✓		

- ✓ Very suitable
- ✓ Suitable



A

Turning

B

Milling

C

Drilling

D

Technical Information

E

Index

Notes

A

Turning

B

Milling

C

Drilling

D

Technical
Information

E

Index

AL series

For machining of aluminium alloys

- For machining of aluminium alloys.
- Newly developed geometries expand our standard program:
 - ALP for high-speed roughing
 - ALG for finishing with very good surface quality
 - AIR torus mills for ultra high-speed machining
- End mills, ball nose cutters, torus mills and rippers
- Diameter range 1.0–20.0 mm



A

End mill General machining of Al and Al alloys

AL-2E

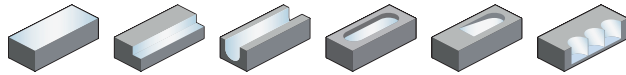

- Factory standard
- Centre cutting
- Helix angle 55°

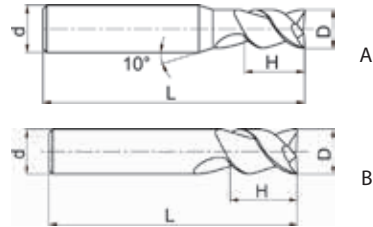

Turning

B

Milling

Article	*	Dimensions [mm]				Teeth	Geometry	Grade
		D	d (h6)	H	L			YK30F
AL-2E-D1.0		1	4	3	50	2	A	●
AL-2E-D1.5		1.5	4	4	50	2	A	●
AL-2E-D2.0		2	4	6	50	2	A	●
AL-2E-D2.5		2.5	4	7	50	2	A	●
AL-2E-D3.0		3	6	9	50	2	A	●
AL-2E-D4.0		4	6	12	50	2	A	●
AL-2E-D5.0		5	6	15	50	2	A	●
AL-2E-D6.0		6	6	18	60	2	B	●
AL-2E-D8.0		8	8	20	60	2	B	●
AL-2E-D10.0		10	10	30	75	2	B	●
AL-2E-D12.0		12	12	32	75	2	B	●
AL-2E-D16.0		16	16	45	100	2	B	●
AL-2E-D20.0		20	20	45	100	2	B	●

● Ex stock ○ On demand

* With internal cooling

C

Drilling

D

Technical Information

Application field

P	M	K	N	S	H
			✓		

✓ Very suitable

✓ Suitable

Index

System code > B258

Cutting data > B422

Nonstandard order > B461

End mill long cutting edge **General machining of Al and Al alloys**

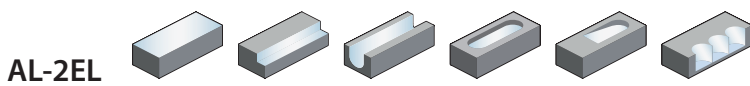

- Factory standard
- Centre cutting
- Helix angle 55°

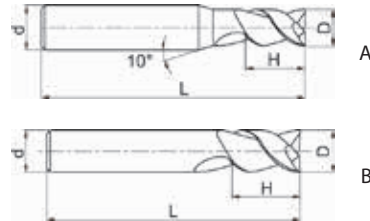

Article	*	Dimensions [mm]				Teeth	Geometry	Grade
		D	d (h6)	H	L			YK30F
AL-2EL-D3.0		3	6	12	60	2	A	●
AL-2EL-D4.0		4	6	16	60	2	A	●
AL-2EL-D5.0		5	6	20	60	2	A	●
AL-2EL-D6.0		6	6	25	75	2	B	●
AL-2EL-D8.0		8	8	32	75	2	B	●
AL-2EL-D10.0		10	10	45	100	2	B	●
AL-2EL-D12.0		12	12	45	100	2	B	●
AL-2EL-D16.0		16	16	65	150	2	B	●
AL-2EL-D20.0		20	20	75	150	2	B	●

- Ex stock ○ On demand
- * With internal cooling

Application field					
P	M	K	N	S	H
			✓		

- ✓ Very suitable
- ✓ Suitable

A

Turning

B

Milling

C

Drilling

D

Technical Information

E

Index



A

End mill General machining of Al and Al alloys

ALG-2E

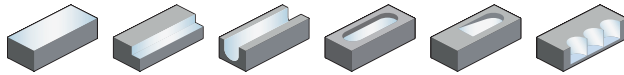

- Factory standard
- Centre cutting
- Helix angle 30°



A

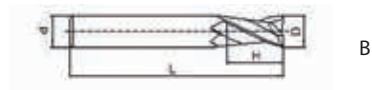

B

Turning

B

Milling

Article	*	Dimensions [mm]				Teeth	Geometry	Grade
		D	d (h6)	H	L			YK40F
ALG-2E-D1.0		1	4	3	50	2	A	●
ALG-2E-D1.5		1.5	4	4	50	2	A	●
ALG-2E-D2.0		2	4	6	50	2	A	●
ALG-2E-D2.5		2.5	4	8	50	2	A	●
ALG-2E-D3.0S		3	4	8	50	2	A	●
ALG-2E-D3.5S		3.5	4	10	50	2	A	○
ALG-2E-D4.0S		4	4	11	50	2	B	○
ALG-2E-D3.0		3	6	8	50	2	A	●
ALG-2E-D3.5		3.5	6	10	50	2	A	●
ALG-2E-D4.0		4	6	11	50	2	A	●
ALG-2E-D4.5		4.5	6	11	50	2	A	●
ALG-2E-D5.0		5	6	13	50	2	A	●
ALG-2E-D5.5		5.5	6	16	50	2	A	●
ALG-2E-D6.0		6	6	16	50	2	B	●
ALG-2E-D7.0		7	8	20	60	2	A	●
ALG-2E-D8.0		8	8	20	60	2	B	●
ALG-2E-D9.0		9	10	22	75	2	A	●
ALG-2E-D10.0		10	10	25	75	2	B	●
ALG-2E-D11.0		11	12	26	75	2	A	●
ALG-2E-D12.0		12	12	30	75	2	B	●
ALG-2E-D14.0		14	14	32	75	2	B	●
ALG-2E-D16.0		16	16	45	100	2	B	●
ALG-2E-D18.0		18	18	45	100	2	B	●
ALG-2E-D20.0		20	20	45	100	2	B	●

● Ex stock ○ On demand

* With internal cooling

C

Drilling

D

Technical Information

Application field

P	M	K	N	S	H
			✓		

✓ Very suitable

✓ Suitable

E

Index

System code > B258

Cutting data > B422

Nonstandard order > B461

End mill **General machining of Al and Al alloys**

AL-3E

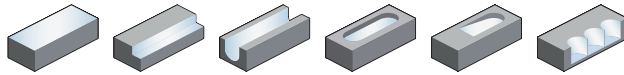

- Factory standard
- Centre cutting
- Helix angle 45°

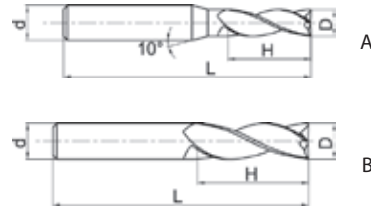

Article	*	Dimensions [mm]				Teeth	Geometry	Grade
		D	d (h6)	H	L			YK30F
AL-3E-D1.0		1	4	3	50	3	A	●
AL-3E-D1.5		1.5	4	4	50	3	A	●
AL-3E-D2.0		2	4	6	50	3	A	●
AL-3E-D2.5		2.5	4	7	50	3	A	●
AL-3E-D3.0		3	6	9	50	3	A	●
AL-3E-D4.0		4	6	12	50	3	A	●
AL-3E-D5.0		5	6	15	50	3	A	●
AL-3E-D6.0		6	6	18	60	3	B	●
AL-3E-D8.0		8	8	20	60	3	B	●
AL-3E-D10.0		10	10	30	75	3	B	●
AL-3E-D12.0		12	12	32	75	3	B	●
AL-3E-D16.0		16	16	45	100	3	B	●
AL-3E-D20.0		20	20	45	100	3	B	●

● Ex stock ○ On demand

* With internal cooling

Application field					
P	M	K	N	S	H
			✓		

✓ Very suitable

✓ Suitable

System code > B258

Cutting data > B422

Nonstandard order > B461



A

End mill long cutting edge General machining of Al and Al alloys

Turning

AL-3EL

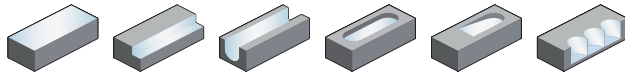

- Factory standard
- Centre cutting
- Helix angle 45°

B

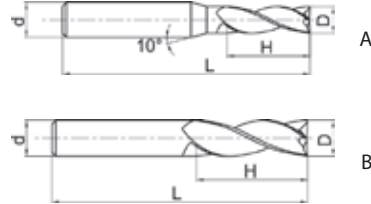

Milling

Article	*	Dimensions [mm]				Teeth	Geometry	Grade
		D	d (h6)	H	L			YK30F
AL-3EL-D3.0		3	6	12	60	3	A	●
AL-3EL-D4.0		4	6	16	60	3	A	●
AL-3EL-D5.0		5	6	20	60	3	A	●
AL-3EL-D6.0		6	6	25	75	3	B	●
AL-3EL-D8.0		8	8	32	75	3	B	●
AL-3EL-D10.0		10	10	45	100	3	B	●
AL-3EL-D12.0		12	12	45	100	3	B	●
AL-3EL-D16.0		16	16	65	150	3	B	●
AL-3EL-D20.0		20	20	75	150	3	B	●

● Ex stock ○ On demand

* With internal cooling

C

Drilling

Application field

P	M	K	N	S	H
			✓		

✓ Very suitable

✓ Suitable

D

Technical Information

E

Index

System code > B258

Cutting data > B422

Nonstandard order > B461

End mill **General machining of Al and Al alloys**

ALG-3E

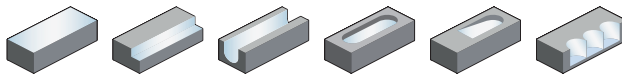

- Factory standard
- Centre cutting
- Helix angle 45°

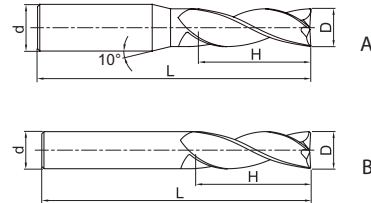

Article	*	Dimensions [mm]				Teeth	Geometry	Grade
		D	d (h6)	H	L			YK40F
ALG-3E-D1.0		1	4	3	50	3	A	●
ALG-3E-D1.5		1.5	4	4	50	3	A	●
ALG-3E-D2.0		2	4	6	50	3	A	●
ALG-3E-D2.5		2.5	4	8	50	3	A	●
ALG-3E-D3.0S		3	4	8	50	3	A	●
ALG-3E-D3.5S		3.5	4	10	50	3	A	○
ALG-3E-D4.0S		4	4	11	50	3	B	○
ALG-3E-D3.0		3	6	8	50	3	A	●
ALG-3E-D3.5		3.5	6	10	50	3	A	○
ALG-3E-D4.0		4	6	11	50	3	A	●
ALG-3E-D4.5		4.5	6	11	50	3	A	●
ALG-3E-D5.0		5	6	13	50	3	A	●
ALG-3E-D5.5		5.5	6	16	50	3	A	●
ALG-3E-D6.0		6	6	16	50	3	B	●
ALG-3E-D7.0		7	8	20	60	3	A	●
ALG-3E-D8.0		8	8	20	60	3	B	●
ALG-3E-D9.0		9	10	22	75	3	A	●
ALG-3E-D10.0		10	10	25	75	3	B	●
ALG-3E-D11.0		11	12	26	75	3	A	●
ALG-3E-D12.0		12	12	30	75	3	B	●
ALG-3E-D14.0		14	14	32	75	3	B	●
ALG-3E-D16.0		16	16	45	100	3	B	●
ALG-3E-D18.0		18	18	45	100	3	B	●
ALG-3E-D20.0		20	20	45	100	3	B	●

- Ex stock ○ On demand
- * With internal cooling

Application field					
P	M	K	N	S	H
			✓		

- ✓ Very suitable
- ✓ Suitable

System code > B258 Cutting data > B422 Nonstandard order > B461



A

End mill High-performance machining of Al and Al alloys

ALP-3E

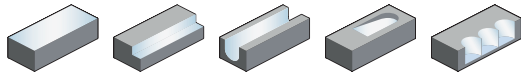

- Factory standard
- Centre cutting
- Helix angle 35°

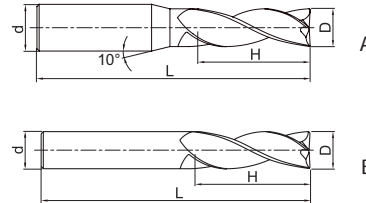

Turning

B

Milling

Article	*	Dimensions [mm]				Teeth	Geometry	Grade
		D	d (h6)	H	L			YK40F
ALP-3E-D1.0		1	4	3	50	3	A	●
ALP-3E-D1.5		1.5	4	4	50	3	A	●
ALP-3E-D2.0		2	4	6	50	3	A	●
ALP-3E-D2.5		2.5	4	8	50	3	A	●
ALP-3E-D3.0S		3	4	9	50	3	A	●
ALP-3E-D4.0S		4	4	12	50	3	B	●
ALP-3E-D3.0		3	6	8	50	3	A	●
ALP-3E-D4.0		4	6	11	50	3	A	●
ALP-3E-D4.5		4.5	6	11	50	3	A	●
ALP-3E-D5.0		5	6	13	50	3	A	●
ALP-3E-D5.5		5.5	6	16	50	3	A	●
ALP-3E-D6.0		6	6	16	50	3	B	●
ALP-3E-D7.0		7	8	20	60	3	B	○
ALP-3E-D8.0		8	8	20	60	3	B	●
ALP-3E-D9.0		9	10	22	75	3	B	●
ALP-3E-D10.0		10	10	25	75	3	B	●
ALP-3E-D11.0		11	12	26	75	3	B	●
ALP-3E-D12.0		12	12	30	75	3	B	●
ALP-3E-D14.0		14	14	32	75	3	B	●
ALP-3E-D16.0		16	16	45	100	3	B	●
ALP-3E-D20.0		20	20	45	100	3	B	○

● Ex stock ○ On demand

* With internal cooling

C

Drilling

D

Technical Information

Application field

P	M	K	N	S	H
			✓		

✓ Very suitable

✓ Suitable

E

Index

System code > B258

Cutting data > B422

Nonstandard order > B461

End mill High-performance machining of Al and Al alloys

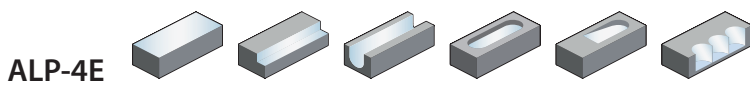

- Factory standard
- Centre cutting
- Helix angle 38°

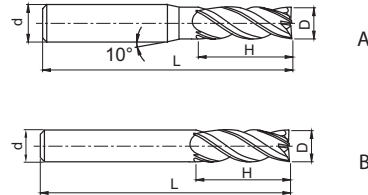

Article	*	Dimensions [mm]				Teeth	Geometry	Grade
		D	d (h6)	H	L			YK40F
ALP-4E-D3.0S		3	4	9	50	4	A	●
ALP-4E-D4.0S		4	4	11	50	4	B	●
ALP-4E-D3.0		3	6	9	50	4	A	●
ALP-4E-D4.0		4	6	11	50	4	A	●
ALP-4E-D5.0		5	6	13	50	4	A	●
ALP-4E-D6.0		6	6	16	50	4	B	●
ALP-4E-D8.0		8	8	20	60	4	B	●
ALP-4E-D10.0		10	10	25	75	4	B	●
ALP-4E-D12.0		12	12	30	75	4	B	●
ALP-4E-D16.0		16	16	45	100	4	B	●
ALP-4E-D18.0		18	18	45	100	4	B	●
ALP-4E-D20.0		20	20	45	100	4	B	●

● Ex stock ○ On demand

* With internal cooling

Application field					
P	M	K	N	S	H
			✓		

✓ Very suitable

✓ Suitable

System code > B258

Cutting data > B422

Nonstandard order > B461



A

Turning

B

Milling

C

Drilling

D

Technical Information

E

Index

A

End mill serrated teeth General machining of Al and Al alloys

AL-3W

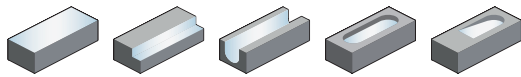

- Factory standard
- Centre cutting
- Helix angle 30°

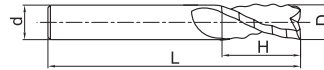

Turning

B

Article	*	Dimensions [mm]				Teeth	Grade
		D	d (h6)	H	L		YK30F
AL-3W-D6.0		6	6	16	50	3	●
AL-3W-D8.0		8	8	20	60	3	●
AL-3W-D10.0		10	10	25	75	3	●
AL-3W-D12.0		12	12	30	75	3	●
AL-3W-D16.0		16	16	45	100	3	●
AL-3W-D20.0		20	20	45	100	3	●

- Ex stock ○ On demand
- * With internal cooling

Milling

C

Application field						✓ Very suitable
P	M	K	N	S	H	
			✓			✓ Suitable

Drilling

D

Technical Information

E

Index

System code > B258

Cutting data > B422

Nonstandard order > B461

Ball nose cutter High performance machining of heat-resistant alloys

5565R302NH

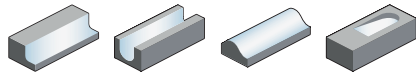

- Type of shank DIN 6535HA
- Centre cutting
- Helix angle 30°

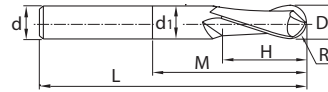

Article	*	Dimensions [mm]							Teeth	Grade	
		D	R	d (h6)	d ₁	H	M	L		YK40F	
5565R302NH-0300		3	1.5	6	2.8	6	9	57	2	●	
5565R302NH-0400		4	2	6	3.7	8	12	57	2	●	
5565R302NH-0500		5	2.5	6	4.6	10	15	57	2	●	
5565R302NH-0600		6	3	6	5.5	12	20	57	2	●	
5565R302NH-0800		8	4	8	7.4	16	26	63	2	●	
5565R302NH-1000		10	5	10	9.2	20	31	72	2	●	
5565R302NH-1200		12	6	12	11	24	37	83	2	●	
5565R302NH-1600		16	8	16	15	32	43	92	2	●	

● Ex stock ○ On demand

* With internal cooling

Application field					
P	M	K	N	S	H
			✓		

✓ Very suitable

✓ Suitable

System code > B258

Cutting data > B422

Nonstandard order > B461



A

Ball nose cutter long shank High performance machining of heat-resistant alloys

5566R302NH

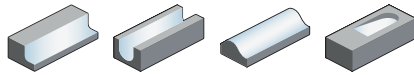

- Type of shank DIN 6535HA
- Centre cutting
- Helix angle 30°

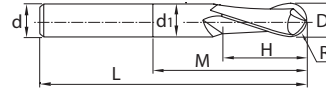

Turning

B

Article	*	Dimensions [mm]							Teeth	Grade
		D	R	d (h6)	d ₁	H	M	L		YK40F
5566R302NH-0300		3	1.5	6	2.8	6	9	75	2	●
5566R302NH-0400		4	2	6	3.7	8	12	75	2	●
5566R302NH-0500		5	2.5	6	4.6	10	15	80	2	●
5566R302NH-0600		6	3	6	5.5	12	20	80	2	●
5566R302NH-0800		8	4	8	7.4	16	26	90	2	●
5566R302NH-1000		10	5	10	9.2	20	31	100	2	●
5566R302NH-1200		12	6	12	11	24	37	120	2	●
5566R302NH-1600		16	8	16	15	32	43	140	2	●

● Ex stock ○ On demand

* With internal cooling

Milling

C

Application field

P	M	K	N	S	H
			✓		

✓ Very suitable

✓ Suitable

Drilling

D

Technical Information

E

Index

System code > B258

Cutting data > B422

Nonstandard order > B461

Ball nose cutter **General machining of Al and Al alloys**

AL-2B

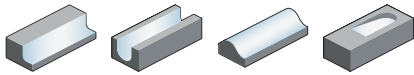

- Factory standard
- Centre cutting
- Helix angle 35°

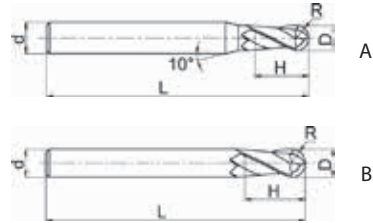

Article	*	Dimensions [mm]					Teeth	Geometry	Grade
		D	R	d (h6)	H	L			YK30F
AL-2B-R1.0		2	1	6	4	60	2	A	●
AL-2B-R1.5		3	1.5	6	6	60	2	A	●
AL-2B-R2.0		4	2	6	8	60	2	A	●
AL-2B-R2.5		5	2.5	6	10	60	2	A	●
AL-2B-R3.0		6	3	6	12	60	2	B	●
AL-2B-R4.0		8	4	8	16	75	2	B	●
AL-2B-R5.0		10	5	10	20	75	2	B	●
AL-2B-R6.0		12	6	12	24	75	2	B	●

- Ex stock ○ On demand
- * With internal cooling

Application field					
P	M	K	N	S	H
			✓		

- ✓ Very suitable
- ✓ Suitable

A

Turning

B

Milling

C

Drilling

D

Technical Information

E

Index

A

Torus mill General machining of Al and Al alloys

Turning

AL-2R-AIR

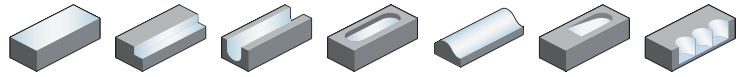

- Factory standard
- Centre cutting
- Helix angle 30°

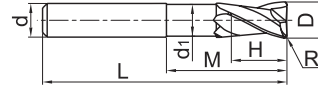

B

Milling

Article	*	Dimensions [mm]							Teeth	Grade
		D	R	d (h6)	d ₁	H	M	L		YK40F
AL-2R-D6.0R1.0-AIR		6	1	6	5.5	7	20	57	2	●
AL-2R-D8.0R1.0-AIR		8	1	8	7.4	9	26	63	2	●
AL-2R-D10.0R1.0-AIR		10	1	10	9.2	11	31	72	2	●
AL-2R-D10.0R2.0-AIR		10	2	10	9.2	11	31	72	2	●
AL-2R-D12.0R1.0-AIR		12	1	12	11	12	37	83	2	●
AL-2R-D12.0R2.0-AIR		12	2	12	11	12	37	83	2	●
AL-2R-D12.0R3.0-AIR		12	3	12	11	12	37	83	2	●
AL-2R-D16.0R1.0-AIR		16	1	16	15	16	43	92	2	●
AL-2R-D16.0R2.0-AIR		16	2	16	15	16	43	92	2	●
AL-2R-D16.0R3.0-AIR		16	3	16	15	16	43	92	2	●
AL-2R-D16.0R4.0-AIR		16	4	16	15	16	43	92	2	●
AL-2R-D20.0R1.0-AIR		20	1	20	19	20	53	104	2	●
AL-2R-D20.0R2.0-AIR		20	2	20	19	20	53	104	2	●
AL-2R-D20.0R3.0-AIR		20	3	20	19	20	53	104	2	●
AL-2R-D20.0R4.0-AIR		20	4	20	19	20	53	104	2	●
AL-2R-D20.0R5.0-AIR		20	5	20	19	20	53	104	2	●
AL-2R-D20.0R6.0-AIR		20	6	20	19	20	53	104	2	●

● Ex stock ○ On demand

* With internal cooling

C

Drilling

D

Technical Information

E

Index

Application field					
P	M	K	N	S	H
			✓		

✓ Very suitable
 ✓ Suitable

System code > B258

Cutting data > B422

Nonstandard order > B461



Torus mill long shank **General machining of Al and Al alloys**

AL-2RL-AIR

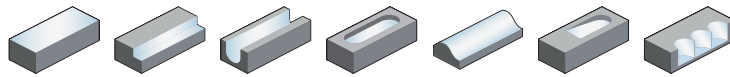

- Factory standard
- Centre cutting
- Helix angle 30°

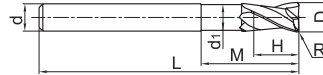

Article	*	Dimensions [mm]							Teeth	Grade
		D	R	d (h6)	d ₁	H	M	L		YK40F
AL-2RL-D6.0R1.0-AIR		6	1	6	5.5	7	43	80	2	●
AL-2RL-D8.0R1.0-AIR		8	1	8	7.4	9	53	90	2	●
AL-2RL-D10.0R1.0-AIR		10	1	10	9.2	11	59	100	2	●
AL-2RL-D10.0R2.0-AIR		10	2	10	9.2	11	59	100	2	●
AL-2RL-D12.0R1.0-AIR		12	1	12	11	12	74	120	2	●
AL-2RL-D12.0R2.0-AIR		12	2	12	11	12	74	120	2	●
AL-2RL-D12.0R3.0-AIR		12	3	12	11	12	74	120	2	●
AL-2RL-D16.0R1.0-AIR		16	1	16	15	16	84	140	2	●
AL-2RL-D16.0R2.0-AIR		16	2	16	15	16	84	140	2	●
AL-2RL-D16.0R3.0-AIR		16	3	16	15	16	84	140	2	●
AL-2RL-D16.0R4.0-AIR		16	4	16	15	16	84	140	2	●
AL-2RL-D20.0R1.0-AIR		20	1	20	19	20	89	140	2	○
AL-2RL-D20.0R2.0-AIR		20	2	20	19	20	89	140	2	●
AL-2RL-D20.0R3.0-AIR		20	3	20	19	20	89	140	2	●
AL-2RL-D20.0R4.0-AIR		20	4	20	19	20	89	140	2	●
AL-2RL-D20.0R5.0-AIR		20	5	20	19	20	89	140	2	○
AL-2RL-D20.0R6.0-AIR		20	6	20	19	20	89	140	2	○

● Ex stock ○ On demand

* With internal cooling

Application field					
P	M	K	N	S	H
			✓		

✓ Very suitable

✓ Suitable

System code > B258

Cutting data > B422

Nonstandard order > B461



A

Turning

B

Milling

C

Drilling

D

Technical Information

E

Index

End mill **General machining of Al and Al alloys**

ALG-2R

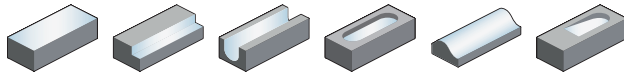

- Straight shank
- Centre cutting
- Helix angle 30°

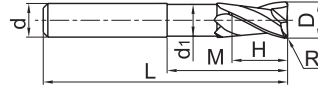

Article	*	Dimensions [mm]							Teeth	Grade
		D	R	d (h6)	d ₁	H	M	L		YK40F
ALG-2R-D6.0R0.3		6	0.3	6	5.7	8	16	75	2	●
ALG-2R-D6.0R0.5		6	0.5	6	5.7	8	16	75	2	●
ALG-2R-D6.0R1.0		6	1	6	5.7	8	16	75	2	●
ALG-2R-D8.0R0.3		8	0.3	8	7.4	10	20	75	2	●
ALG-2R-D8.0R0.5		8	0.5	8	7.4	10	20	75	2	●
ALG-2R-D8.0R1.0		8	1	8	7.4	10	20	75	2	●
ALG-2R-D10.0R0.5		10	0.5	10	9.4	12	35	100	2	●
ALG-2R-D10.0R1.0		10	1	10	9.4	12	35	100	2	●
ALG-2R-D10.0R1.6		10	1.6	10	9.4	12	35	100	2	●
ALG-2R-D10.0R2.5		10	2.5	10	9.4	12	35	100	2	●
ALG-2R-D12.0R0.5		12	0.5	12	11.4	15	35	100	2	●
ALG-2R-D12.0R1.0		12	1	12	11.4	15	35	100	2	●
ALG-2R-D12.0R1.6		12	1.6	12	11.4	15	35	100	2	●
ALG-2R-D12.0R2.5		12	2.5	12	11.4	15	35	100	2	●
ALG-2R-D12.0R3.2		12	3.2	12	11.4	15	35	100	2	●
ALG-2R-D12.0R4.0		12	4	12	11.4	15	35	100	2	●
ALG-2R-D16.0R1.0		16	1	16	15.4	15	45	125	2	●
ALG-2R-D16.0R1.6		16	1.6	16	15.4	15	45	125	2	●
ALG-2R-D16.0R2.5		16	2.5	16	15.4	15	45	125	2	●
ALG-2R-D16.0R3.2		16	3.2	16	15.4	15	45	125	2	●
ALG-2R-D16.0R4.0		16	4	16	15.4	15	45	125	2	●
ALG-2R-D16.0R6.3		16	6.3	16	15.4	15	45	125	2	○
ALG-2R-D20.0R1.0		20	1	20	18	20	50	125	2	●
ALG-2R-D20.0R1.6		20	1.6	20	18	20	50	125	2	●
ALG-2R-D20.0R2.5		20	2.5	20	18	20	50	125	2	●
ALG-2R-D20.0R3.2		20	3.2	20	18	20	50	125	2	●
ALG-2R-D20.0R4.0		20	4	20	18	20	50	125	2	●
ALG-2R-D20.0R6.3		20	6.3	20	18	20	50	125	2	○
ALG-2R-D25.0R6.3		25	6.3	25	23	25	75	150	2	○

● Ex stock ○ On demand

* With internal cooling

Application field

P	M	K	N	S	H
			✓		

✓ Very suitable

✓ Suitable

System code > B258

Cutting data > B422

Nonstandard order > B461

Torus mill **General machining of Al and Al alloys**

AL-3R-AIR

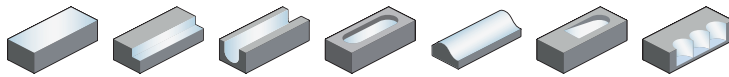

- Factory standard
- Centre cutting
- Helix angle 30°

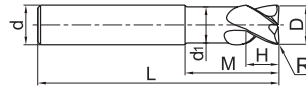

Article	*	Dimensions [mm]							Teeth	Grade
		D	R	d (h6)	d ₁	H	M	L		YK40F
AL-3R-D12.0R1.0-AIR		12	1	12	11	12	37	83	3	●
AL-3R-D12.0R2.0-AIR		12	2	12	11	12	37	83	3	●
AL-3R-D12.0R3.0-AIR		12	3	12	11	12	37	83	3	●
AL-3R-D16.0R1.0-AIR		16	1	16	15	16	43	92	3	●
AL-3R-D16.0R2.0-AIR		16	2	16	15	16	43	92	3	●
AL-3R-D16.0R3.0-AIR		16	3	16	15	16	43	92	3	●
AL-3R-D16.0R4.0-AIR		16	4	16	15	16	43	92	3	●
AL-3R-D20.0R1.0-AIR		20	1	20	19	20	53	104	3	●
AL-3R-D20.0R2.0-AIR		20	2	20	19	20	53	104	3	○
AL-3R-D20.0R3.0-AIR		20	3	20	19	20	53	104	3	○
AL-3R-D20.0R4.0-AIR		20	4	20	19	20	53	104	3	○
AL-3R-D20.0R5.0-AIR		20	5	20	19	20	53	104	3	●
AL-3R-D20.0R6.0-AIR		20	6	20	19	20	53	104	3	○

● Ex stock ○ On demand

* With internal cooling

Application field					
P	M	K	N	S	H
			✓		

✓ Very suitable

✓ Suitable

System code > B258

Cutting data > B422

Nonstandard order > B461



A

Turning

B

Milling

C

Drilling

D

Technical Information

E

Index

A

Torus mill long shank General machining of Al and Al alloys

AL-3RL-AIR

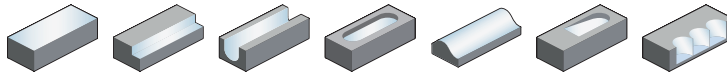

- Factory standard
- Centre cutting
- Helix angle 30°

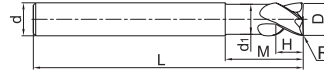

Turning

B

Article	*	Dimensions [mm]							Teeth	Grade
		D	R	d (h6)	d ₁	H	M	L		YK40F
AL-3RL-D12.0R1.0-AIR		12	1	12	11	12	74	120	3	●
AL-3RL-D12.0R2.0-AIR		12	2	12	11	12	74	120	3	●
AL-3RL-D12.0R3.0-AIR		12	3	12	11	12	74	120	3	●
AL-3RL-D16.0R1.0-AIR		16	1	16	15	16	84	140	3	●
AL-3RL-D16.0R2.0-AIR		16	2	16	15	16	84	140	3	○
AL-3RL-D16.0R3.0-AIR		16	3	16	15	16	84	140	3	●
AL-3RL-D16.0R4.0-AIR		16	4	16	15	16	84	140	3	●
AL-3RL-D20.0R1.0-AIR		20	1	20	19	20	89	140	3	●
AL-3RL-D20.0R2.0-AIR		20	2	20	19	20	89	140	3	○
AL-3RL-D20.0R3.0-AIR		20	3	20	19	20	89	140	3	○
AL-3RL-D20.0R4.0-AIR		20	4	20	19	20	89	140	3	○
AL-3RL-D20.0R5.0-AIR		20	5	20	19	20	89	140	3	○
AL-3RL-D20.0R6.0-AIR		20	6	20	19	20	89	140	3	○

Milling

C

- Ex stock ○ On demand
- * With internal cooling

Drilling

Application field					
P	M	K	N	S	H
			✓		

- ✓ Very suitable
- ✓ Suitable

D

Technical Information

E

Index

System code > B258

Cutting data > B422

Nonstandard order > B461

HPC series

High Performance Cutter (HPC)

- For roughing and finishing of steel up to 55 HRC, stainless steel and cast iron.
- Geometry with unequal helix angle (38°/41°) and unequal pitch for smooth machining without vibrations.
- End mills and torus mills
- Diameter range 4.0–20.0 mm



A

End mill HSC/HPC machining

5501R38414GM

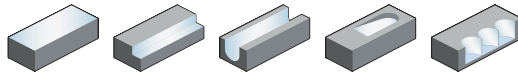

- Type of shank DIN 6535HA
- Centre cutting
- Helix angle 38°/41°

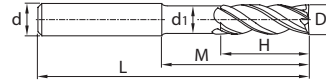

Turning

B

Article	*	Dimensions [mm]						Teeth	Grade
		D	d (h6)	d ₁	H	M	L		KMG405
5501R38414GM-0400		4	6	3.7	8	16	54	4	●
5501R38414GM-0500		5	6	4.7	9	17	54	4	●
5501R38414GM-0600		6	6	5.7	10	18	54	4	●
5501R38414GM-0800		8	8	7.7	12	22	58	4	●
5501R38414GM-1000		10	10	9.5	14	26	66	4	●
5501R38414GM-1200		12	12	11.5	16	28	73	4	●
5501R38414GM-1400		14	14	13.5	18	30	75	4	●
5501R38414GM-1600		16	16	15.5	22	34	82	4	●
5501R38414GM-1800		18	18	17.5	24	36	84	4	●
5501R38414GM-2000		20	20	19.5	26	42	92	4	●

Milling

- Ex stock ○ On demand
- * With internal cooling

C

Application field

P	M	K	N	S	H
✓	✓	✓			✓

- ✓ Very suitable
- ✓ Suitable

Drilling

D

Technical Information

E

Index

System code > B258

Cutting data > B422

Nonstandard order > B461

End mill long cutting edge **HSC/HPC machining**

5502R38414GM

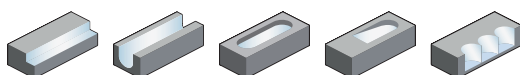

- Type of shank DIN 6535HA
- Centre cutting
- Helix angle 38°/41°

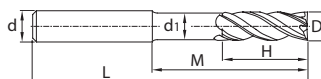

Article	*	Dimensions [mm]						Teeth	Grade
		D	d (h6)	d ₁	H	M	L		KMG405
5502R38414GM-0400		4	6	3.7	11	19	57	4	●
5502R38414GM-0500		5	6	4.7	13	21	57	4	●
5502R38414GM-0600		6	6	5.7	13	21	57	4	●
5502R38414GM-0800		8	8	7.7	19	27	63	4	●
5502R38414GM-1000		10	10	9.5	22	32	72	4	●
5502R38414GM-1200		12	12	11.5	26	38	83	4	●
5502R38414GM-1400		14	14	13.5	26	38	83	4	●
5502R38414GM-1600		16	16	15.5	32	44	92	4	●
5502R38414GM-1800		18	18	17.5	32	44	92	4	●
5502R38414GM-2000		20	20	19.5	38	54	104	4	●

- Ex stock ○ On demand
- * With internal cooling

Application field					
P	M	K	N	S	H
✓	✓	✓			✓

- ✓ Very suitable
- ✓ Suitable

System code > B258

Cutting data > B422

Nonstandard order > B461



A

End mill HSC/HPC machining

5601R38414GM

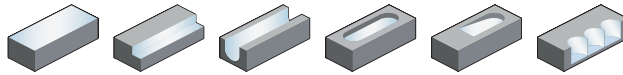

- Type of shank: DIN 6535HB
- Centre cutting
- Helix angle 38°/41°

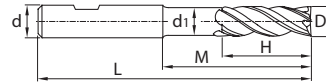

Turning

B

Article	*	Dimensions [mm]						Teeth	Grade
		D	d (h6)	d ₁	H	M	L		KMG405
5601R38414GM-0400		4	6	3.7	8	16	54	4	●
5601R38414GM-0500		5	6	4.7	9	17	54	4	●
5601R38414GM-0600		6	6	5.7	10	18	54	4	●
5601R38414GM-0800		8	8	7.7	12	22	58	4	●
5601R38414GM-1000		10	10	9.5	14	26	66	4	●
5601R38414GM-1200		12	12	11.5	16	28	73	4	●
5601R38414GM-1400		14	14	13.5	18	30	75	4	●
5601R38414GM-1600		16	16	15.5	22	34	82	4	●
5601R38414GM-1800		18	18	17.5	24	36	84	4	●
5601R38414GM-2000		20	20	19.5	26	42	92	4	●

Milling

- Ex stock ○ On demand
- * With internal cooling

C

Application field

P	M	K	N	S	H
✓	✓	✓			✓

- ✓ Very suitable
- ✓ Suitable

Drilling

D

Technical Information

E

Index

System code > B258

Cutting data > B422

Nonstandard order > B461

End mill long cutting edge **HSC/HPC machining**

5602R38414GM

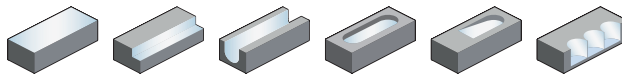

- Type of shank: DIN 6535HB
- Centre cutting
- Helix angle 38°/41°

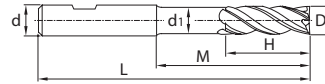

Article	*	Dimensions [mm]						Teeth	Grade
		D	d (h6)	d ₁	H	M	L		KMG405
5602R38414GM-0400		4	6	3.7	11	19	57	4	●
5602R38414GM-0500		5	6	4.7	13	21	57	4	●
5602R38414GM-0600		6	6	5.7	13	21	57	4	●
5602R38414GM-0800		8	8	7.7	19	27	63	4	●
5602R38414GM-1000		10	10	9.5	22	32	72	4	●
5602R38414GM-1200		12	12	11.5	26	38	83	4	●
5602R38414GM-1400		14	14	13.5	26	38	83	4	●
5602R38414GM-1600		16	16	15.5	32	44	92	4	●
5602R38414GM-1800		18	18	17.5	32	44	92	4	●
5602R38414GM-2000		20	20	19.5	38	54	104	4	●

- Ex stock ○ On demand
- * With internal cooling

Application field					
P	M	K	N	S	H
✓	✓	✓			✓

- ✓ Very suitable
- ✓ Suitable



A

Turning

B

Milling

C

Drilling

D

Technical Information

E

Index

Torus mill long cutting edge **HSC/HPC machining**

5502R38414GM-R

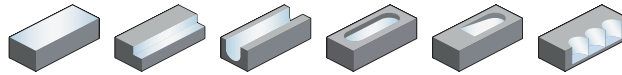

- Type of shank DIN 6535HA
- Centre cutting
- Helix angle 38°/41°

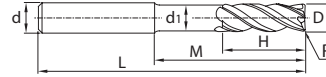

Article	*	Dimensions [mm]							Teeth	Grade
		D	R	d (h6)	d ₁	H	M	L		
5502R38414GM-R02-0400		4	0.2	6	3.7	11	19	57	4	●
5502R38414GM-R05-0400		4	0.5	6	3.7	11	19	57	4	●
5502R38414GM-R02-0500		5	0.2	6	4.7	13	21	57	4	●
5502R38414GM-R05-0500		5	0.5	6	4.7	13	21	57	4	●
5502R38414GM-R02-0600		6	0.2	6	5.7	13	21	57	4	●
5502R38414GM-R05-0600		6	0.5	6	5.7	13	21	57	4	●
5502R38414GM-R10-0600		6	1	6	5.7	13	21	57	4	●
5502R38414GM-R02-0800		8	0.2	8	7.7	19	27	63	4	●
5502R38414GM-R05-0800		8	0.5	8	7.7	19	27	63	4	●
5502R38414GM-R10-0800		8	1	8	7.7	19	27	63	4	●
5502R38414GM-R15-0800		8	1.5	8	7.7	19	27	63	4	●
5502R38414GM-R20-0800		8	2	8	7.7	19	27	63	4	●
5502R38414GM-R02-1000		10	0.2	10	9.5	22	32	72	4	●
5502R38414GM-R05-1000		10	0.5	10	9.5	22	32	72	4	●
5502R38414GM-R10-1000		10	1	10	9.5	22	32	72	4	●
5502R38414GM-R15-1000		10	1.5	10	9.5	22	32	72	4	●
5502R38414GM-R20-1000		10	2	10	9.5	22	32	72	4	●
5502R38414GM-R05-1200		12	0.5	12	11.5	26	38	83	4	●
5502R38414GM-R10-1200		12	1	12	11.5	26	38	83	4	●
5502R38414GM-R15-1200		12	1.5	12	11.5	26	38	83	4	●
5502R38414GM-R20-1200		12	2	12	11.5	26	38	83	4	●
5502R38414GM-R10-1600		16	1	16	15.5	32	44	92	4	●
5502R38414GM-R15-1600		16	1.5	16	15.5	32	44	92	4	●
5502R38414GM-R20-1600		16	2	16	15.5	32	44	92	4	●
5502R38414GM-R30-1600		16	3	16	15.5	32	44	92	4	●
5502R38414GM-R10-2000		20	1	20	19.5	38	54	104	4	●
5502R38414GM-R15-2000		20	1.5	20	19.5	38	54	104	4	●
5502R38414GM-R20-2000		20	2	20	19.5	38	54	104	4	●
5502R38414GM-R30-2000		20	3	20	19.5	38	54	104	4	●

● Ex stock ○ On demand

* With internal cooling

Application field

P	M	K	N	S	H
✓	✓	✓			✓

✓ Very suitable

✓ Suitable

System code > B258

Cutting data > B422

Nonstandard order > B461

Torus mill long cutting edge **HSC/HPC machining**

5602R38414GM-R

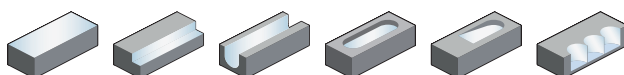

- Type of shank: DIN 6535HB
- Centre cutting
- Helix angle 38°/41°

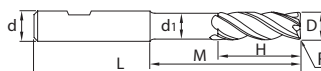

Article	*	Dimensions [mm]							Teeth	Grade	
		D	R	d (h6)	d ₁	H	M	L		KMG405	
5602R38414GM-R02-0400		4	0.2	6	3.7	11	19	57	4	●	
5602R38414GM-R05-0400		4	0.5	6	3.7	11	19	57	4	●	
5602R38414GM-R02-0500		5	0.2	6	4.7	13	21	57	4	●	
5602R38414GM-R05-0500		5	0.5	6	4.7	13	21	57	4	●	
5602R38414GM-R02-0600		6	0.2	6	5.7	13	21	57	4	●	
5602R38414GM-R05-0600		6	0.5	6	5.7	13	21	57	4	●	
5602R38414GM-R10-0600		6	1	6	5.7	13	21	57	4	●	
5602R38414GM-R02-0800		8	0.2	8	7.7	19	27	63	4	●	
5602R38414GM-R05-0800		8	0.5	8	7.7	19	27	63	4	●	
5602R38414GM-R10-0800		8	1	8	7.7	19	27	63	4	●	
5602R38414GM-R15-0800		8	1.5	8	7.7	19	27	63	4	●	
5602R38414GM-R20-0800		8	2	8	7.7	19	27	63	4	●	
5602R38414GM-R02-1000		10	0.2	10	9.5	22	32	72	4	●	
5602R38414GM-R05-1000		10	0.5	10	9.5	22	32	72	4	●	
5602R38414GM-R10-1000		10	1	10	9.5	22	32	72	4	●	
5602R38414GM-R15-1000		10	1.5	10	9.5	22	32	72	4	●	
5602R38414GM-R20-1000		10	2	10	9.5	22	32	72	4	●	
5602R38414GM-R05-1200		12	0.5	12	11.5	26	38	83	4	●	
5602R38414GM-R10-1200		12	1	12	11.5	26	38	83	4	●	
5602R38414GM-R15-1200		12	1.5	12	11.5	26	38	83	4	●	
5602R38414GM-R20-1200		12	2	12	11.5	26	38	83	4	●	
5602R38414GM-R10-1600		16	1	16	15.5	32	44	92	4	●	
5602R38414GM-R15-1600		16	1.5	16	15.5	32	44	92	4	●	
5602R38414GM-R20-1600		16	2	16	15.5	32	44	92	4	●	
5602R38414GM-R30-1600		16	3	16	15.5	32	44	92	4	●	
5602R38414GM-R10-2000		20	1	20	19.5	38	54	104	4	●	
5602R38414GM-R15-2000		20	1.5	20	19.5	38	54	104	4	●	
5602R38414GM-R20-2000		20	2	20	19.5	38	54	104	4	●	
5602R38414GM-R30-2000		20	3	20	19.5	38	54	104	4	●	

● Ex stock ○ On demand

* With internal cooling

Application field					
P	M	K	N	S	H
✓	✓	✓			✓

✓ Very suitable

✓ Suitable

System code > B258

Cutting data > B422

Nonstandard order > B461



UM series

High Speed Cutter (HSC)

- For roughing and finishing of steel up to 55 HRC, stainless steel and cast iron with high metal removal rate.
- Optimised geometry with unequal helix angle (38°/41°) and unequal pitch.
- End mills and torus mills
- Diameter range 4.0–20.0 mm



A

End mill HSC/HPC machining

UM-4E

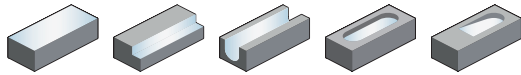

- Factory standard
- Centre cutting
- Helix angle 38°/41°

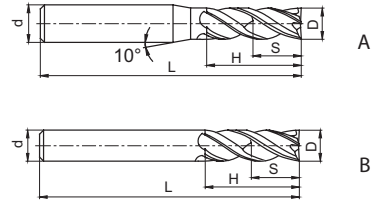

Turning

B

Milling

Article	*	Dimensions [mm]					Teeth	Geometry	Grade
		D	d (h6)	H	L	S			KMG405
UM-4E-D4.0S		4	4	11	50	6	4	B	●
UM-4E-D4.0		4	6	11	50	6	4	A	●
UM-4E-D4.5		4.5	6	11	50	6.75	4	A	●
UM-4E-D5.0		5	6	13	50	7.5	4	A	●
UM-4E-D5.5		5.5	6	16	50	8.25	4	A	●
UM-4E-D6.0		6	6	16	50	9	4	B	●
UM-4E-D7.0		7	8	20	60	10.5	4	A	●
UM-4E-D8.0		8	8	20	60	12	4	B	●
UM-4E-D9.0		9	10	22	75	13.5	4	A	●
UM-4E-D10.0		10	10	25	75	15	4	B	●
UM-4E-D11.0		11	12	26	75	16.5	4	A	●
UM-4E-D12.0		12	12	30	75	18	4	B	●
UM-4E-D14.0		14	14	32	75	21	4	B	●
UM-4E-D16.0		16	16	45	100	24	4	B	●
UM-4E-D18.0		18	18	45	100	27	4	B	●
UM-4E-D20.0		20	20	45	100	30	4	B	●

● Ex stock ○ On demand

* With internal cooling

C

Drilling

D

Technical Information

Application field

P	M	K	N	S	H
✓	✓	✓			✓

✓ Very suitable

✓ Suitable

E

Index

System code > B258

Cutting data > B422

Nonstandard order > B461

End mill **HSC/HPC machining**

UM-4E-W

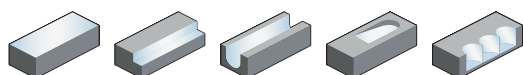

- Factory standard with weldon clamping surface
- Centre cutting
- Helix angle 38°/41°

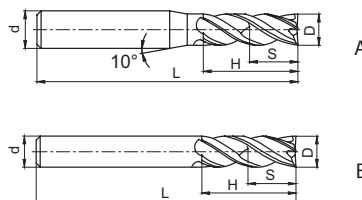

Article	*	Dimensions [mm]					Teeth	Geometry	Grade
		D	d (h6)	H	L	S			KMG405
UM-4E-D4.0S-W		4	4	11	50	6	4	B	●
UM-4E-D4.0-W		4	6	11	50	6	4	A	●
UM-4E-D4.5-W		4.5	6	11	50	6.75	4	A	●
UM-4E-D5.0-W		5	6	13	50	7.5	4	A	●
UM-4E-D5.5-W		5.5	6	16	50	8.25	4	A	●
UM-4E-D6.0-W		6	6	16	50	9	4	B	●
UM-4E-D7.0-W		7	8	20	60	10.5	4	A	●
UM-4E-D8.0-W		8	8	20	60	12	4	B	●
UM-4E-D9.0-W		9	10	22	75	13.5	4	A	●
UM-4E-D10.0-W		10	10	25	75	15	4	B	●
UM-4E-D11.0-W		11	12	26	75	16.5	4	A	●
UM-4E-D12.0-W		12	12	30	75	18	4	B	●
UM-4E-D14.0-W		14	14	32	75	21	4	B	●
UM-4E-D16.0-W		16	16	45	100	24	4	B	●
UM-4E-D18.0-W		18	18	45	100	27	4	B	●
UM-4E-D20.0-W		20	20	45	100	30	4	B	●

● Ex stock ○ On demand

* With internal cooling

Application field					
P	M	K	N	S	H
✓	✓	✓			✓

✓ Very suitable

✓ Suitable

System code > B258

Cutting data > B422

Nonstandard order > B461



A

End mill long cutting edge HSC/HPC machining

UM-4EL

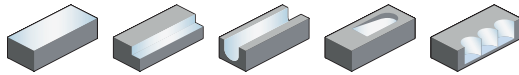

- Factory standard
- Centre cutting
- Helix angle 38°/41°

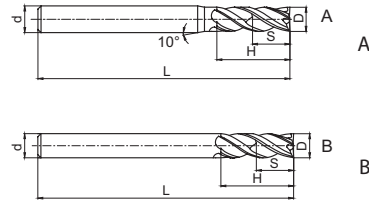

Turning

B

Milling

Article	*	Dimensions [mm]					Teeth	Geometry	Grade
		D	d (h6)	H	L	S			KMG405
UM-4EL-D4.0		4	6	15	75	6	4	A	●
UM-4EL-D5.0		5	6	20	75	7.5	4	A	●
UM-4EL-D6.0		6	6	20	75	9	4	B	●
UM-4EL-D8.0		8	8	25	100	12	4	B	●
UM-4EL-D10.0		10	10	30	100	15	4	B	●
UM-4EL-D12.0		12	12	35	100	18	4	B	●
UM-4EL-D14.0		14	14	40	100	21	4	B	●
UM-4EL-D16.0		16	16	50	150	24	4	B	●
UM-4EL-D20.0		20	20	55	150	30	4	B	●

● Ex stock ○ On demand

* With internal cooling

C

Drilling

Application field

P	M	K	N	S	H
✓	✓	✓			✓

- ✓ Very suitable
- ✓ Suitable

D

Technical Information

E

Index

System code > B258

Cutting data > B422

Nonstandard order > B461

End mill long cutting edge **HSC/HPC machining**

UM-4EL-W

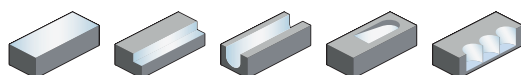

- Factory standard with weldon clamping surface
- Centre cutting
- Helix angle 38°/41°

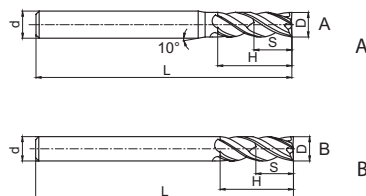

Article	*	Dimensions [mm]					Teeth	Geometry	Grade
		D	d (h6)	H	L	S			KMG405
UM-4EL-D4.0-W		4	6	15	75	6	4	A	●
UM-4EL-D5.0-W		5	6	20	75	7.5	4	A	●
UM-4EL-D6.0-W		6	6	20	75	9	4	B	●
UM-4EL-D8.0-W		8	8	25	100	12	4	B	●
UM-4EL-D10.0-W		10	10	30	100	15	4	B	●
UM-4EL-D12.0-W		12	12	35	100	18	4	B	●
UM-4EL-D14.0-W		14	14	40	100	21	4	B	●
UM-4EL-D16.0-W		16	16	50	150	24	4	B	●
UM-4EL-D20.0-W		20	20	55	150	30	4	B	●

● Ex stock ○ On demand

* With internal cooling

Application field					
P	M	K	N	S	H
✓	✓	✓			✓

- ✓ Very suitable
- ✓ Suitable

A

Turning

B

Milling

C

Drilling

D

Technical Information

E

Index

System code > B258

Cutting data > B422

Nonstandard order > B461



A

End mill reduced neck HSC/HPC machining

UM-4ELP-W

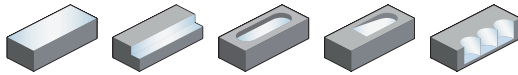

- Factory standard with weldon clamping surface
- Centre cutting
- Helix angle 38°/41°

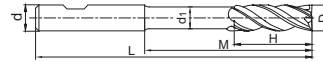

Turning

B

Article	*	Dimensions [mm]						Teeth	Grade
		D	d (h6)	d ₁	H	M	L		KMG405
UM-4ELP-D4.0-W		4	6	3.8	15	36	75	4	●
UM-4ELP-D5.0-W		5	6	4.8	20	36	75	4	●
UM-4ELP-D6.0-W		6	6	5.7	20	36	75	4	●
UM-4ELP-D8.0-W		8	8	7.7	25	60	100	4	●
UM-4ELP-D10.0-W		10	10	9.5	30	55	100	4	●
UM-4ELP-D12.0-W		12	12	11.5	35	50	100	4	●
UM-4ELP-D14.0-W		14	14	13.5	40	50	100	4	●
UM-4ELP-D16.0-W		16	16	15.5	50	100	150	4	●
UM-4ELP-D20.0-W		20	20	19.5	55	98	150	4	●

Milling

- Ex stock ○ On demand
- * With internal cooling

C

Application field

P	M	K	N	S	H
✓	✓	✓			✓

- ✓ Very suitable
- ✓ Suitable

Drilling

D

Technical Information

E

Index

System code > B258

Cutting data > B422

Nonstandard order > B461

End mill short cutting edge **HSC/HPC machining**

UM-4EFP

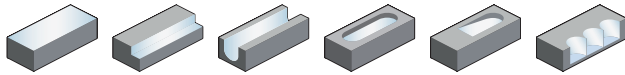

- Factory standard
- Centre cutting
- Helix angle 38°/41°

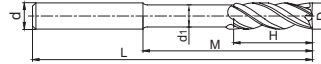

Article	*	Dimensions [mm]						Teeth	Grade
		D	d (h6)	d ₁	H	M	L		KMG405
UM-4EFP-D6.0		6	6	5.8	9	30	75	4	●
UM-4EFP-D8.0		8	8	7.8	12	40	100	4	●
UM-4EFP-D10.0		10	10	9.6	15	50	100	4	●
UM-4EFP-D12.0		12	12	11.5	18	50	100	4	●
UM-4EFP-D16.0		16	16	15.5	24	50	150	4	●
UM-4EFP-D20.0		20	20	19.5	30	60	150	4	●

- Ex stock ○ On demand
- * With internal cooling

Application field

P	M	K	N	S	H
✓	✓	✓			✓

- ✓ Very suitable
- ✓ Suitable

A

Turning

B

Milling

C

Drilling

D

Technical Information

E

Index

System code > B258

Cutting data > B422

Nonstandard order > B461



A

Torus mill HSC/HPC machining

UM-4R

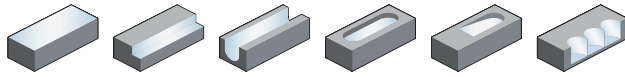

- Factory standard
- Centre cutting
- Helix angle 38°/41°

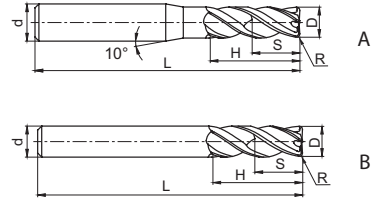

Turning

B

Milling

C

Drilling

D

Technical Information

E

Index

Article	*	Dimensions [mm]						Teeth	Geometry	Grade
		D	R	d (h6)	H	L	S			
UM-4R-D4.0R0.3		4	0.3	6	10	50	6	4	A	●
UM-4R-D4.0R0.5		4	0.5	6	10	50	6	4	A	●
UM-4R-D5.0R0.5		5	0.5	6	13	50	7.5	4	A	●
UM-4R-D5.0R1.0		5	1	6	13	50	7.5	4	A	●
UM-4R-D6.0R0.5		6	0.5	6	16	50	9	4	B	●
UM-4R-D6.0R1.0		6	1	6	16	50	9	4	B	●
UM-4R-D8.0R0.5		8	0.5	8	20	60	12	4	B	●
UM-4R-D8.0R1.0		8	1	8	20	60	12	4	B	●
UM-4R-D10.0R0.5		10	0.5	10	25	75	15	4	B	●
UM-4R-D10.0R1.0		10	1	10	25	75	15	4	B	●
UM-4R-D10.0R2.0		10	2	10	25	75	15	4	B	●
UM-4R-D10.0R3.0		10	3	10	25	75	15	4	B	●
UM-4R-D12.0R0.5		12	0.5	12	30	75	18	4	B	●
UM-4R-D12.0R1.0		12	1	12	30	75	18	4	B	●
UM-4R-D12.0R2.0		12	2	12	30	75	18	4	B	●
UM-4R-D12.0R3.0		12	3	12	30	75	18	4	B	●
UM-4R-D16.0R1.0		16	1	16	45	100	24	4	B	●
UM-4R-D16.0R2.0		16	2	16	45	100	24	4	B	●
UM-4R-D16.0R3.0		16	3	16	45	100	24	4	B	●
UM-4R-D20.0R1.0		20	1	20	45	100	30	4	B	●
UM-4R-D20.0R2.0		20	2	20	45	100	30	4	B	●
UM-4R-D20.0R3.0		20	3	20	45	100	30	4	B	●

- Ex stock ○ On demand
- * With internal cooling

Application field

P	M	K	N	S	H
✓	✓	✓			✓

- ✓ Very suitable
- ✓ Suitable

System code > B258

Cutting data > B422

Nonstandard order > B461

Torus mill long shank

HSC/HPC machining

UM-4RL

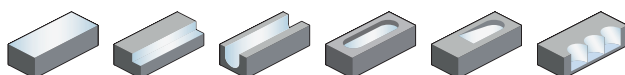

- Factory standard
- Centre cutting
- Helix angle 38°/41°

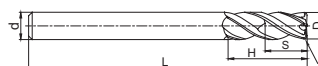

Article	*	Dimensions [mm]						Teeth	Grade
		D	R	d (h6)	H	L	S		KMG405
UM-4RL-D6.0R0.5		6	0.5	6	16	75	9	4	●
UM-4RL-D6.0R1.0		6	1	6	16	75	9	4	●
UM-4RL-D8.0R0.5		8	0.5	8	20	100	12	4	●
UM-4RL-D8.0R1.0		8	1	8	20	100	12	4	●
UM-4RL-D10.0R0.5		10	0.5	10	25	100	15	4	●
UM-4RL-D10.0R1.0		10	1	10	25	100	15	4	●
UM-4RL-D10.0R2.0		10	2	10	25	100	15	4	●
UM-4RL-D12.0R0.5		12	0.5	12	30	100	18	4	●
UM-4RL-D12.0R1.0		12	1	12	30	100	18	4	●
UM-4RL-D12.0R2.0		12	2	12	30	100	18	4	●
UM-4RL-D16.0R1.0		16	1	16	45	150	24	4	●
UM-4RL-D16.0R2.0		16	2	16	45	150	24	4	●

● Ex stock ○ On demand

* With internal cooling

Application field					
P	M	K	N	S	H
✓	✓	✓			✓

✓ Very suitable

✓ Suitable

System code > B258

Cutting data > B422

Nonstandard order > B461



A

Torus mill short cutting edge HSC/HPC machining

UM-4RFP

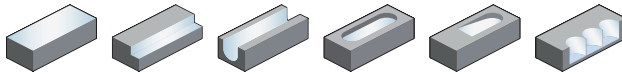

- Factory standard
- Centre cutting
- Helix angle 38°/41°

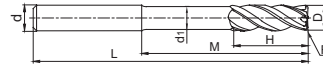

Turning

B

Article	*	Dimensions [mm]							Teeth	Grade
		D	R	d (h6)	d ₁	H	M	L		
UM-4RFP-D6.0R0.5		6	0.5	6	5.8	6	18	75	4	●
UM-4RFP-D6.0R1.0		6	1	6	5.8	6	18	75	4	●
UM-4RFP-D8.0R0.5		8	0.5	8	7.7	8	24	100	4	●
UM-4RFP-D8.0R1.0		8	1	8	7.7	8	24	100	4	●
UM-4RFP-D10.0R0.5		10	0.5	10	9.6	10	30	100	4	●
UM-4RFP-D10.0R1.0		10	1	10	9.6	10	30	100	4	●
UM-4RFP-D10.0R2.0		10	2	10	9.6	10	30	100	4	●
UM-4RFP-D12.0R0.5		12	0.5	12	11.5	12	36	100	4	●
UM-4RFP-D12.0R1.0		12	1	12	11.5	12	36	100	4	●
UM-4RFP-D12.0R2.0		12	2	12	11.5	12	36	100	4	●
UM-4RFP-D16.0R1.0		16	1	16	15.5	16	40	150	4	●
UM-4RFP-D16.0R2.0		16	2	16	15.5	16	40	150	4	●

Milling

C

- Ex stock ○ On demand
- * With internal cooling

Drilling

Application field					
P	M	K	N	S	H
✓	✓	✓			✓

✓ Very suitable
 ✓ Suitable

D

Technical Information

E

Index

System code > B258

Cutting data > B422

Nonstandard order > B461

VSM series

With sharp cutting edge for heat-resistant alloys

- For roughing and finishing of steel, stainless steel and heat-resistant alloys with high metal removal rates.
- Sharp cutting edge with unequal helix angle (38°/41°) and unequal pitch.
- Smooth machining without vibrations.
- End mills and torus mills
- Diameter range 4.0–20.0 mm



A

End mill General machining of heat-resistant alloys

VSM-4E

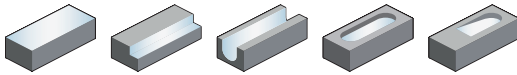

- Factory standard
- Centre cutting
- Helix angle 38°/41°

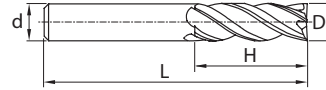

Turning

B

Article	*	Dimensions [mm]				Teeth	Grade
		D	d (h6)	H	L		KMG405
VSM-4E-D4.0		4	6	11	50	4	●
VSM-4E-D5.0		5	6	13	50	4	●
VSM-4E-D6.0		6	6	16	50	4	●
VSM-4E-D8.0		8	8	20	60	4	●
VSM-4E-D10.0		10	10	25	75	4	●
VSM-4E-D12.0		12	12	30	75	4	●
VSM-4E-D16.0		16	16	45	100	4	●
VSM-4E-D20.0		20	20	45	100	4	●

● Ex stock ○ On demand

* With internal cooling

Milling

C

Application field

P	M	K	N	S	H
✓	✓			✓	

✓ Very suitable

✓ Suitable

Drilling

D

Technical Information

E

Index

System code > B258

Cutting data > B422

Nonstandard order > B461

End mill **General machining of heat-resistant alloys**

VSM-4E-C

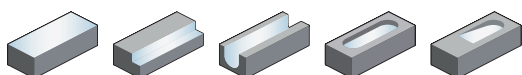

- Factory standard
- Coolant exit, radial
- Centre cutting
- Helix angle 38°/41°

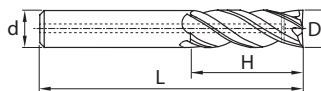

Article	*	Dimensions [mm]				Teeth	Grade
		D	d (h6)	H	L		KMG405
VSM-4E-C-D8.0	*	8	8	20	60	4	○
VSM-4E-C-D10.0	*	10	10	25	75	4	●
VSM-4E-C-D12.0	*	12	12	30	75	4	●
VSM-4E-C-D16.0	*	16	16	45	100	4	●
VSM-4E-C-D20.0	*	20	20	45	100	4	●

● Ex stock ○ On demand

* With internal cooling

Application field

P	M	K	N	S	H
✓	✓			✓	

✓ Very suitable

✓ Suitable

A

Turning

B

Milling

C

Drilling

D

Technical Information

E

Index

System code > B258

Cutting data > B422

Nonstandard order > B461



A

Turning

Torus mill General machining of heat-resistant alloys

VSM-4R

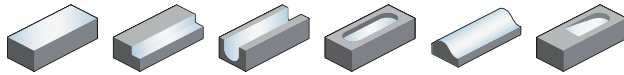

- Factory standard
- Centre cutting
- Helix angle 38°/41°

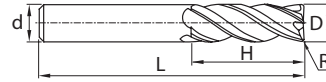

B

Milling

Article	*	Dimensions [mm]					Teeth	Grade
		D	R	d (h6)	H	L		KMG405
VSM-4R-D4.0R0.2		4	0.2	6	11	50	4	●
VSM-4R-D4.0R0.5		4	0.5	6	11	50	4	●
VSM-4R-D5.0R0.2		5	0.2	6	13	50	4	●
VSM-4R-D5.0R0.5		5	0.5	6	13	50	4	●
VSM-4R-D6.0R0.2		6	0.2	6	16	50	4	●
VSM-4R-D6.0R0.5		6	0.5	6	16	50	4	●
VSM-4R-D6.0R1.0		6	1	6	16	50	4	●
VSM-4R-D6.0R1.5		6	1.5	6	16	50	4	●
VSM-4R-D8.0R0.5		8	0.5	8	20	63	4	●
VSM-4R-D8.0R0.8		8	0.8	8	20	63	4	●
VSM-4R-D8.0R1.0		8	1	8	20	63	4	●
VSM-4R-D8.0R1.5		8	1.5	8	20	63	4	●
VSM-4R-D8.0R2.0		8	2	8	20	63	4	●
VSM-4R-D10.0R0.5		10	0.5	10	25	75	4	●
VSM-4R-D10.0R0.8		10	0.8	10	25	75	4	●
VSM-4R-D10.0R1.0		10	1	10	25	75	4	●
VSM-4R-D10.0R1.5		10	1.5	10	25	75	4	●
VSM-4R-D10.0R2.0		10	2	10	25	75	4	●
VSM-4R-D12.0R0.5		12	0.5	12	30	75	4	●
VSM-4R-D12.0R0.8		12	0.8	12	30	75	4	●
VSM-4R-D12.0R1.0		12	1	12	30	75	4	●
VSM-4R-D12.0R1.5		12	1.5	12	30	75	4	●
VSM-4R-D12.0R2.0		12	2	12	30	75	4	●
VSM-4R-D12.0R2.5		12	2.5	12	30	75	4	●
VSM-4R-D12.0R3.0		12	3	12	30	75	4	●
VSM-4R-D12.0R4.0		12	4	12	30	75	4	●
VSM-4R-D16.0R0.5		16	0.5	16	45	100	4	●
VSM-4R-D16.0R0.8		16	0.8	16	45	100	4	●
VSM-4R-D16.0R1.0		16	1	16	45	100	4	●
VSM-4R-D16.0R1.5		16	1.5	16	45	100	4	●
VSM-4R-D16.0R2.0		16	2	16	45	100	4	●
VSM-4R-D16.0R2.5		16	2.5	16	45	100	4	●
VSM-4R-D16.0R3.0		16	3	16	45	100	4	●
VSM-4R-D16.0R4.0		16	4	16	45	100	4	●
VSM-4R-D20.0R0.5		20	0.5	20	45	100	4	●
VSM-4R-D20.0R1.0		20	1	20	45	100	4	●
VSM-4R-D20.0R1.5		20	1.5	20	45	100	4	●

● Ex stock ○ On demand

* With internal cooling

C

Drilling

D

Technical Information

E

Index

Application field

P	M	K	N	S	H
✓	✓			✓	

✓ Very suitable

✓ Suitable

System code > B258

Cutting data > B422

Nonstandard order > B461

Torus mill **General machining of heat-resistant alloys**

VSM-4R

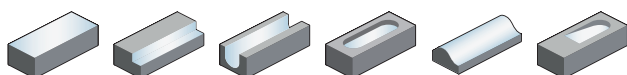

- Factory standard
- Centre cutting
- Helix angle 38°/41°

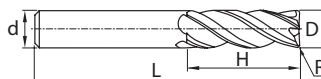

Article	*	Dimensions [mm]					Teeth	Grade
		D	R	d (h6)	H	L		KMG405
VSM-4R-D20.0R2.0		20	2	20	45	100	4	●
VSM-4R-D20.0R2.5		20	2.5	20	45	100	4	●
VSM-4R-D20.0R3.0		20	3	20	45	100	4	●
VSM-4R-D20.0R4.0		20	4	20	45	100	4	●

- Ex stock ○ On demand
- * With internal cooling

Application field					
P	M	K	N	S	H
✓	✓			✓	

- ✓ Very suitable
- ✓ Suitable

A Turning

B Milling

C Drilling

D Technical Information

E Index

Deburring Cutter



Deburring cutter 60° General machining

5501/5601R60*FM



- Type of shank DIN 6535HA
- Type of shank: DIN 6535HB
- Non-centre cutting
- Helix angle 0°

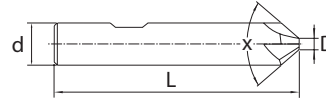

Article	*	Dimensions [mm]					Teeth	Grade
		d (h6)	L	D	Shank	X		KMG303
5501R603FM-0300		3	48	0,2	HA	60	3	●
5501R604FM-0400		4	48	0,2	HA	60	4	●
5601R604FM-0600		6	55	0,2	HB	60	4	●
5601R604FM-0800		8	58	0,5	HB	60	4	●
5601R604FM-1000		10	65	0,5	HB	60	4	●
5601R606FM-1000		10	65	0,7	HB	60	6	●
5601R604FM-1200		12	75	0,5	HB	60	4	●
5601R606FM-1200		12	75	0,7	HB	60	6	●
5601R604FM-1600		16	85	0,7	HB	60	4	●
5601R606FM-1600		16	85	0,7	HB	60	6	●

● Ex stock ○ On demand

* With internal cooling

Application field

P	M	K	N	S	H
✓	✓	✓	✓		

- ✓ Very suitable
- ✓ Suitable

System code > B258

Cutting data > B422

Nonstandard order > B461

Deburring cutter 90°

General machining

5501/5601R90*FM



- Type of shank DIN 6535HA
- Type of shank: DIN 6535HB
- Non-centre cutting
- Helix angle 0°

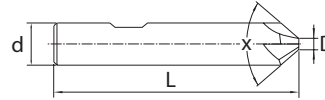

Article	*	Dimensions [mm]					Teeth	Grade
		d (h6)	L	D	Shank	X		KMG303
5501R903FM-0300		3	48	0,2	HA	90	3	●
5501R904FM-0400		4	48	0,2	HA	90	4	●
5601R904FM-0600		6	55	0,2	HB	90	4	●
5601R904FM-0800		8	58	0,5	HB	90	4	●
5601R904FM-1000		10	65	0,5	HB	90	4	●
5601R906FM-1000		10	65	0,7	HB	90	6	●
5601R904FM-1200		12	75	0,5	HB	90	4	●
5601R906FM-1200		12	75	0,7	HB	90	6	●
5601R904FM-1600		16	85	0,7	HB	90	4	●
5601R906FM-1600		16	85	0,7	HB	90	6	●

- Ex stock ○ On demand
- * With internal cooling

Application field					
P	M	K	N	S	H
✓	✓	✓	✓		

- ✓ Very suitable
- ✓ Suitable

System code > B258

Cutting data > B422

Nonstandard order > B461



Quarter round profile mill

General machining

5601R90*FM-R



- Type of shank: DIN 6535HB
- Non-centre cutting
- Helix angle 0°

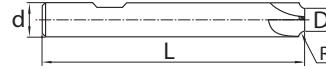

Article	*	Dimensions [mm]				Teeth	Grade
		d (h6)	L	D	R		KMG303
5601R904FM-R02-0600		6	60	5,6	0,2	4	●
5601R904FM-R03-0600		6	60	5,4	0,3	4	●
5601R904FM-R04-0600		6	60	5,2	0,4	4	●
5601R904FM-R05-0800		8	70	7,0	0,5	4	●
5601R904FM-R06-0800		8	70	6,8	0,6	4	●
5601R904FM-R075-0800		8	70	6,5	0,75	4	●
5601R904FM-R08-0800		8	70	6,4	0,8	4	●
5601R904FM-R10-0800		8	70	6,0	1,0	4	●
5601R904FM-R15-1000		10	75	7,0	1,5	4	●
5601R904FM-R20-1000		10	75	6,0	2,0	4	●
5601R904FM-R25-1200		12	75	7,0	2,5	4	●
5601R904FM-R30-1200		12	75	6,0	3,0	4	●
5601R904FM-R40-1600		16	80	8,0	4,0	4	●
5601R904FM-R50-2000		20	80	10,0	5,0	4	●

● Ex stock ○ On demand

* With internal cooling

Application field

P	M	K	N	S	H
✓	✓	✓	✓		

✓ Very suitable

✓ Suitable

System code > B258

Cutting data > B422

Nonstandard order > B461

A

Turning

B

Milling

C

Drilling

D

Technical Information

E

Index

Guide for recommended cutting data – solid carbide milling

End mill – GM series

1	Material group	Composition / structure / heat treatment	hardness HB	Machining group	Starting values for cutting speed v_c (m/min)								
					5501R302GM 5601R302GM 5502R302GM 5602R302GM				GM-2E GM-2EFP GM-2F				
					Slot milling		Shoulder milling		Slot milling		Shoulder milling		
					ϕ [mm]	$a_{p,max}$	ϕ [mm]	$a_{p,max}$	ϕ [mm]	$a_{p,max}$	ϕ [mm]	$a_{p,max}$	
					$0 < x < 3$	$0,1 \times D$	$0 < x \leq 20$	$< 0,5 \times D$	$0 < x < 3$	$0,1 \times D$	$0 < x \leq 20$	$< 0,5 \times D$	
					$3 \leq x \leq 20$	$0,8 \times D$			$3 \leq x \leq 20$	$0,8 \times D$			
					KMG303				KMG303				
					a / D				a / D				
					1/1	1/2	1/10	f-group	1/1	1/2	1/10	f-group	
P	Unalloyed steel	ca. 0,15 % C	annealed	125	1	150	200	270	2	150	200	270	2
		ca. 0,45 % C	annealed	190	2	145	190	260	2	145	190	260	2
		ca. 0,45 % C	tempered	250	3	105	140	190	2	105	140	190	2
		ca. 0,75 % C	annealed	270	4	90	120	165	2	90	120	165	2
		ca. 0,75 % C	tempered	300	5	85	110	150	2	85	110	150	2
	Low-alloyed steel		annealed	180	6	115	150	205	2	115	150	205	2
			tempered	275	7	90	120	165	2	90	120	165	2
			tempered	300	8	85	110	150	2	85	110	150	2
			tempered	350	9	80	105	145	2	80	105	145	2
			tempered	350	9	80	105	145	2	80	105	145	2
High-alloyed steel and high-alloyed tool steel		annealed	200	10	105	140	190	2	105	140	190	2	
		hardened and tempered	325	11	80	110	145	2	80	110	145	2	
M	Stainless steel	ferritic/martensitic	annealed	200	12	50	65	90	2	50	65	90	2
		martensitic	tempered	240	13	45	60	80	2	45	60	80	2
		austenitic	quench hardened	180	14	55	70	95	2	55	70	95	2
		austenitic-ferritic		230	15	45	60	80	2	45	60	80	2
				230	15	45	60	80	2	45	60	80	2
K	Grey cast iron	perlitic/ferritic		180	16	110	150	200	2	110	150	200	2
		perlitic (martensitic)		260	17	90	120	165	2	90	120	165	2
	Cast iron with spheroidal graphite	ferritic		160	18	135	180	245	2	135	180	245	2
perlitic			250	19	105	140	190	2	105	140	190	2	
Malleable cast iron	ferritic		130	20	150	200	270	2	150	200	270	2	
	perlitic		230	21	120	160	220	2	120	160	220	2	
N	Aluminium wrought alloys	cannot be hardened		60	22								
		hardenable	hardened	100	23								
	Cast aluminium alloys	$\leq 12\%$ Si, cannot be hardened		75	24								
		$\leq 12\%$ Si, hardenable	hardened	90	25								
		$> 12\%$ Si, cannot be hardened		130	26								
Copper and copper alloys (bronze/brass)	machining steel, Pb > 1%		110	27									
	CuZn, CuSnZn		90	28									
	CuSn, Pb-free copper, electrolytic copper		100	29									
S	Heat-resistant alloys	Fe-based alloys	annealed	200	30								
			hardened	280	31								
		Ni or Co base	annealed	250	32								
			hardened	350	33								
		cast	320	34									
Titanium alloys	pure titanium		R_m 400	35									
	α and β alloys	hardened	R_m 1050	36									
H	Hardened steel			55 HRC	37								
	Hard cast iron			60 HRC	38								
	Hardened cast iron			400	39								
X	Non-metallic materials	Thermoplasts			41								
		Thermosetting plastics			42								
		Plastic, glass-fibre reinforced GFRP			43								
		Plastic, carbon fibre reinforced CFRP			44								
		Graphite			45								
		Wood			46								

Note: The given cutting values are guide values, which were determined under ideal conditions.
 The values have to be adapted in individual cases.
 Feed rate recommendations on page B444.
 For examples of material for cutting tool groups view page D22.

Recommend feed rate

Solid carbide milling group 2 – Square shoulder mills GM series

	S _{max} [mm]	Feed rate per cutting edge (f _z) [mm]														
		Ø0,5	Ø0,8	Ø 1	Ø 2	Ø 3	Ø 4	Ø 5	Ø 6	Ø 8	Ø 10	Ø 12	Ø 14	Ø 16	Ø 18	Ø 20
P	1/1	0,01	0,02	0,02	0,02	0,02	0,02	0,03	0,03	0,04	0,06	0,07	0,07	0,08	0,08	0,09
	1/2	0,01	0,03	0,03	0,03	0,03	0,03	0,04	0,04	0,05	0,08	0,09	0,09	0,10	0,10	0,12
M	1/1	0,01	0,02	0,02	0,02	0,02	0,02	0,02	0,02	0,03	0,05	0,06	0,06	0,06	0,06	0,07
	1/2	0,01	0,02	0,02	0,02	0,02	0,02	0,03	0,03	0,04	0,06	0,07	0,07	0,08	0,08	0,09
K	1/1	0,01	0,02	0,02	0,02	0,02	0,02	0,03	0,03	0,04	0,06	0,07	0,07	0,08	0,08	0,09
	1/2	0,01	0,03	0,03	0,03	0,03	0,03	0,04	0,04	0,05	0,08	0,09	0,09	0,10	0,10	0,12
5	1/10	0,02	0,03	0,03	0,03	0,03	0,03	0,05	0,05	0,06	0,10	0,11	0,11	0,13	0,13	0,15
	1/20	0,02	0,04	0,04	0,04	0,04	0,04	0,06	0,06	0,08	0,12	0,14	0,14	0,16	0,16	0,18

Note: The above cutting data are guide values, which were determined under ideal conditions. The values have to be adapted in individual cases.

1. Select the appropriate product series.
2. Determine the immersion.
3. Select the used material and read the cutting speed.
4. Determine the feed rate group and have a look at the appropriate feed rate recommendations.
5. Select the diameter of tool and determine the immersion.

A

Turning

B

Milling

C

Drilling

D

Technical Information

E

Index

End mill – GM series

Material group	Composition / structure / heat treatment	Brinell hardness HB	Machining group	Starting values for cutting speed v_c [m/min]									
				5501R304GF 5601R304GF 5502R304GF 5602R304GF					GM-4F-G GM-4EFP				
				Slot milling		Shoulder milling			Slot milling		Shoulder milling		
				\varnothing [mm]	a_p max	\varnothing [mm]	a_e max	\varnothing [mm]	a_p max	\varnothing [mm]	a_e max		
$0 < x < 3$	$0,1 \times D$	$0 < x \leq 20$	$< 0,5 \times D$	$0 < x < 3$	$0,1 \times D$	$0 < x \leq 20$	$< 0,5 \times D$						
$3 \leq x \leq 20$	$0,8 \times D$			$3 \leq x \leq 20$	$0,8 \times D$								
KMG303					KMG303								
a_e / D				a_e / D									
1/1	1/2	1/10	f-group	1/1	1/2	1/10	f-group						
P Unalloyed steel	ca. 0,15 % C	annealed	125	1	155	200	265	2	150	200	270	2	
	ca. 0,45 % C	annealed	190	2	150	190	255	2	145	190	260	2	
	ca. 0,45 % C	tempered	250	3	110	140	190	2	105	140	190	2	
	ca. 0,75 % C	annealed	270	4	95	120	160	2	90	120	165	2	
	ca. 0,75 % C	tempered	300	5	90	110	150	2	85	110	150	2	
P Low-alloyed steel		annealed	180	6	120	150	200	2	115	150	205	2	
		tempered	275	7	95	120	160	2	90	120	165	2	
		tempered	300	8	90	110	150	2	85	110	150	2	
		tempered	350	9	85	105	140	2	80	105	145	2	
P High-alloyed steel and high-alloyed tool steel		annealed	200	10	110	140	190	2	105	140	190	2	
		hardened and tempered	325	11	85	110	145	2	80	110	145	2	
M Stainless steel	ferritic/martensitic	annealed	200	12	50	65	85	2	50	65	90	2	
	martensitic	tempered	240	13	45	60	75	2	45	60	80	2	
	austenitic	quench hardened	180	14	55	70	95	2	55	70	95	2	
	austenitic-ferritic		230	15	45	60	75	2	45	60	80	2	
K Grey cast iron	perlitic/ferritic		180	16	115	150	195	2	110	150	200	2	
	perlitic (martensitic)		260	17	95	120	160	2	90	120	165	2	
K Cast iron with spheroidal graphite	ferritic		160	18	140	180	240	2	135	180	245	2	
	perlitic		250	19	110	140	190	2	105	140	190	2	
K Malleable cast iron	ferritic		130	20	155	200	265	2	150	200	270	2	
	perlitic		230	21	125	160	215	2	120	160	220	2	
N Aluminium wrought alloys	cannot be hardened		60	22									
	hardenable	hardened	100	23									
	$\leq 12\% \text{ Si}$, cannot be hardened		75	24									
	$\leq 12\% \text{ Si}$, hardenable	hardened	90	25									
N Cast aluminium alloys	$> 12\% \text{ Si}$, cannot be hardened		130	26									
	machining steel, PB> 1%		110	27									
	CuZn, CuSnZn		90	28									
N Copper and copper alloys (bronze/brass)	CuSn, Pb-free copper, electrolytic copper		100	29									
	S Heat-resistant alloys	Fe-based alloys	annealed	200	30								
		hardened	280	31									
S Ni or Co bass	annealed	250	32										
	hardened	350	33										
S Titanium alloys	cast	320	34										
	pure titanium		R_m 400	35									
H Hardened steel	α and β alloys	hardened	R_m 1050	36									
	hardened and tempered	55 HRC	37										
H Hard cast iron	hardened and tempered	60 HRC	38										
	cast	400	39										
H Hardened cast iron	hardened and tempered	55 HRC	40										
X Non-metallic materials	Thermoplasts			41									
	Thermosetting plastics			42									
	Plastic, glass-fibre reinforced GFRP			43									
	Plastic, carbon fibre reinforced CFRP			44									
	Graphite			45									
	Wood			46									

Note: The given cutting values are guide values, which were determined under ideal conditions.

The values have to be adapted in individual cases.

Feed rate recommendations on page B444.

For examples of material for cutting tool groups view page D22.

End mill – GM series

Material group	Composition / structure / heat treatment		Brinell hardness HB	Machining group	Starting values for cutting speed v_c [m/min]							
					GM-2BL GM-4BL GM-2BFP				GM-2R GM-4R			
									Slot milling		Shoulder milling	
									\varnothing [mm]	$a_{p\max}$	\varnothing [mm]	$a_{e\max}$
				$0 < x < 3$				$0 < x \leq 20$				
				$3 \leq x \leq 20$				$0,8 \times D$				
				KMG303				KMG303				
				a_e / D				a_e / D				
				1/1	1/10	1/20	f-group	1/1	1/2	1/10	f-group	
P Unalloyed steel	ca. 0,15 % C	annealed	125	1	220	250	5	160	215	275	2	
	ca. 0,45 % C	annealed	190	2	210	240	5	155	205	265	2	
	ca. 0,45 % C	tempered	250	3	155	175	5	115	155	195	2	
	ca. 0,75 % C	annealed	270	4	135	150	5	100	130	165	2	
	ca. 0,75 % C	tempered	300	5	125	140	5	90	120	155	2	
P Low-alloyed steel		annealed	180	6	165	190	5	120	165	210	2	
		tempered	275	7	135	150	5	100	130	165	2	
		tempered	300	8	125	140	5	90	120	155	2	
		tempered	350	9	115	130	5	85	115	145	2	
High-alloyed steel and high-alloyed tool steel		annealed	200	10	155	175	5	115	155	195	2	
		hardened and tempered	325	11	120	135	5	85	115	150	2	
M Stainless steel	ferritic/martensitic	annealed	200	12	75	80	5	55	70	90	2	
	martensitic	tempered	240	13	65	70	5	45	65	80	2	
	austenitic	quench hardened	180	14	75	85	5	55	75	95	2	
	austenitic-ferritic		230	15	65	70	5	45	65	80	2	
K Grey cast iron	perlitic/ferritic		180	16	165	185	5	120	160	205	2	
	perlitic (martensitic)		260	17	135	150	5	100	130	165	2	
K Cast iron with spheroidal graphite	ferritic		160	18	200	225	5	145	195	250	2	
	perlitic		250	19	155	175	5	115	155	195	2	
K Malleable cast iron	ferritic		130	20	220	250	5	160	215	275	2	
	perlitic		230	21	180	200	5	130	175	220	2	
N Aluminium wrought alloys	cannot be hardened		60	22								
	hardenable	hardened	100	23								
	$\leq 12\%$ Si, cannot be hardened		75	24								
	$\leq 12\%$ Si, hardenable	hardened	90	25								
N Cast aluminium alloys	$> 12\%$ Si, cannot be hardened		130	26								
	machining steel, PB> 1%		110	27								
	CuZn, CuSnZn		90	28								
S Copper and copper alloys (bronze/brass)	CuSn, Pb-free copper, electrolytic copper		100	29								
	S Heat-resistant alloys	Fe-based alloys	annealed	200	30							
		hardened	280	31								
S Ni or Co bass	annealed	250	32									
	hardened	350	33									
S Titanium alloys	cast	320	34									
	pure titanium		R_m 400	35								
H Hardened steel	α and β alloys	hardened	R_m 1050	36								
	hardened and tempered	55 HRC		37								
H Hard cast iron	hardened and tempered	60 HRC		38								
	cast	400		39								
H Hardened cast iron	hardened and tempered	55 HRC		40								
X Non-metallic materials	Thermoplasts			41								
	Thermosetting plastics			42								
	Plastic, glass-fibre reinforced GFRP			43								
	Plastic, carbon fibre reinforced CFRP			44								
	Graphite			45								
	Wood			46								

Note: The given cutting values are guide values, which were determined under ideal conditions.
 The values have to be adapted in individual cases.
 Feed rate recommendations on page B444.
 For examples of material for cutting tool groups view page D22.

End mill – HM series

Material group	Composition / structure / heat treatment		Brinell hardness HB	Machining group	Starting values for cutting speed v_c [m/min]								
					HM-2E HM-2EP HM-2ES HM-4E				HM-2EFP HM-4EL HM-4EFP				
					Shoulder milling		Shoulder milling						
					\emptyset [mm]	a_e max	\emptyset [mm]	a_e max					
		$0 < x \leq 20$		$0 < x \leq 20$		$0,05 \times D$		$0 < x \leq 20$		$0,05 \times D$			
				KMG555				KMG555					
				a_e / D		a_e / D		a_e / D		a_e / D			
		1/1	1/2	1/10	f-group	1/1	1/2	1/10	f-group	1/1	1/2	1/10	f-group
P Unalloyed steel	ca. 0,15 % C	annealed	125	1									
	ca. 0,45 % C	annealed	190	2									
	ca. 0,45 % C	tempered	250	3									
	ca. 0,75 % C	annealed	270	4									
	ca. 0,75 % C	tempered	300	5									
P Low-alloyed steel		annealed	180	6									
		tempered	275	7									
		tempered	300	8									
		tempered	350	9									
High-alloyed steel and high-alloyed tool steel		annealed	200	10									
		hardened and tempered	325	11									
M Stainless steel	ferritic/martensitic	annealed	200	12									
	martensitic	tempered	240	13									
	austenitic	quench hardened	180	14									
	austenitic-ferritic		230	15									
K Grey cast iron	perlitic/ferritic		180	16									
	perlitic (martensitic)		260	17									
K Cast iron with spheroidal graphite	ferritic		160	18									
	perlitic		250	19									
Malleable cast iron	ferritic		130	20									
	perlitic		230	21									
N Aluminium wrought alloys	cannot be hardened		60	22									
	hardenable	hardened	100	23									
	$\leq 12\% \text{ Si}$, cannot be hardened		75	24									
	$\leq 12\% \text{ Si}$, hardenable	hardened	90	25									
	$> 12\% \text{ Si}$, cannot be hardened		130	26									
Copper and copper alloys (bronze/brass)	machining steel, PB> 1%		110	27									
	CuZn, CuSnZn		90	28									
	CuSn, Pb-free copper, electrolytic copper		100	29									
S Heat-resistant alloys	Fe-based alloys	annealed	200	30									
		hardened	280	31									
	Ni or Co bass	annealed	250	32									
		hardened	350	33									
		cast	320	34									
Titanium alloys	pure titanium		R_m 400	35									
	α and β alloys	hardened	R_m 1050	36									
H Hardened steel		hardened and tempered	55 HRC	37	55	100	125	3	50	95	115	3	
		hardened and tempered	60 HRC	38	55	95	120	3	50	95	110	3	
H Hard cast iron		cast	400	39	70	125	160	3	65	120	145	3	
H Hardened cast iron		hardened and tempered	55 HRC	40	55	100	125	3	50	95	115	3	
X Non-metallic materials	Thermoplasts			41									
	Thermosetting plastics			42									
	Plastic, glass-fibre reinforced GFRP			43									
	Plastic, carbon fibre reinforced CFRP			44									
	Graphite			45									
	Wood			46									

Note: The given cutting values are guide values, which were determined under ideal conditions.
 The values have to be adapted in individual cases.
 Feed rate recommendations on page B444.
 For examples of material for cutting tool groups view page D22.

End mill – NM series

Material group	Composition / structure / heat treatment		Brinell hardness HB	Machining group	Starting values for cutting speed v_c [m/min]							
					NM-2E 5502R402NM NM-4E NM-2EP				NM-2B NM-4BP			
					Slot milling		Shoulder milling					
					\varnothing [mm]	a_p max	\varnothing [mm]	a_e max				
$0 < x < 12$	$0.5 \times D$	$0 < x \leq 20$	$< 0.5 \times D$									
$12 \leq x \leq 20$	$1.0 \times D$											
				KMG309				KMG309				
				a_e / D		a_e / D		a_e / D		a_e / D		
		1/1	1/2	1/10	f-group	1/1	1/10	1/20	f-group			
P Unalloyed steel	ca. 0,15 % C	annealed	125	1								
	ca. 0,45 % C	annealed	190	2								
	ca. 0,45 % C	tempered	250	3								
	ca. 0,75 % C	annealed	270	4								
	ca. 0,75 % C	tempered	300	5								
P Low-alloyed steel		annealed	180	6								
		tempered	275	7								
		tempered	300	8								
		tempered	350	9								
High-alloyed steel and high-alloyed tool steel		annealed	200	10								
		hardened and tempered	325	11								
M Stainless steel	ferritic/martensitic	annealed	200	12								
	martensitic	tempered	240	13								
	austenitic	quench hardened	180	14								
	austenitic-ferritic		230	15								
K Grey cast iron	perlitic/ferritic		180	16								
	perlitic (martensitic)		260	17								
K Cast iron with spheroidal graphite	ferritic		160	18								
	perlitic		250	19								
K Malleable cast iron	ferritic		130	20								
	perlitic		230	21								
N Aluminium wrought alloys	cannot be hardened		60	22	920	1100	1200	4	1400	1550	4	
	hardenable	hardened	100	23	555	660	720	4	840	930	4	
	$\leq 12\% \text{ Si}$, cannot be hardened		75	24	370	440	480	4	560	620	4	
	$\leq 12\% \text{ Si}$, hardenable	hardened	90	25	460	550	600	4	700	775	4	
	$> 12\% \text{ Si}$, cannot be hardened		130	26	140	165	180	4	210	235	4	
N Cast aluminium alloys	machining steel, PB > 1%		110	27	280	330	360	4	420	465	4	
	CuZn, CuSnZn		90	28	325	385	420	4	490	545	4	
	CuSn, Pb-free copper, electrolytic copper		100	29	280	330	360	4	420	465	4	
S Copper and copper alloys (bronze/brass)	Fe-based alloys	annealed	200	30								
		hardened	280	31								
	Ni or Co bass	annealed	250	32								
		hardened	350	33								
		cast	320	34								
S Titanium alloys	pure titanium		R_m 400	35								
	α and β alloys	hardened	R_m 1050	36								
H Hardened steel		hardened and tempered	55 HRC	37								
		hardened and tempered	60 HRC	38								
H Hard cast iron		cast	400	39								
H Hardened cast iron		hardened and tempered	55 HRC	40								
X Non-metallic materials	Thermoplasts			41								
	Thermosetting plastics			42								
	Plastic, glass-fibre reinforced GFRP			43								
	Plastic, carbon fibre reinforced CFRP			44								
	Graphite			45								
	Wood			46								

Note: The given cutting values are guide values, which were determined under ideal conditions.
 The values have to be adapted in individual cases.
 Feed rate recommendations on page B444.
 For examples of material for cutting tool groups view page D22.

End mill – AL series

Material group	Composition / structure / heat treatment	Brinell hardness HB	Machining group	Starting values for cutting speed v_c [m/min]								
				AL-1E AL-2E ALG-2E AL-3E				AL-2EL AL-3EL AL-3W				
				Slot milling		Shoulder milling		Slot milling		Shoulder milling		
				\varnothing [mm]	a_p max	\varnothing [mm]	a_e max	\varnothing [mm]	a_p max	\varnothing [mm]	a_e max	
				$0 < x < 12$	$0.5 \times D$	$0 < x \leq 20$	$< 0.5 \times D$	$0 < x < 12$	$0.5 \times D$	$0 < x \leq 20$	$< 0.5 \times D$	
				$12 \leq x \leq 20$	$1.0 \times D$			$12 \leq x \leq 20$	$1.0 \times D$			
				YK30F / YK40F				YK30F				
				a_e / D				a_e / D				
				1/1	1/2	1/10	f-group	1/1	1/2	1/10	f-group	
P Unalloyed steel	ca. 0,15 % C	annealed	125	1								
	ca. 0,45 % C	annealed	190	2								
	ca. 0,45 % C	tempered	250	3								
	ca. 0,75 % C	annealed	270	4								
	ca. 0,75 % C	tempered	300	5								
P Low-alloyed steel		annealed	180	6								
		tempered	275	7								
		tempered	300	8								
P High-alloyed steel and high-alloyed tool steel		annealed	200	10								
		hardened and tempered	325	11								
M Stainless steel	ferritic/martensitic	annealed	200	12								
	martensitic	tempered	240	13								
	austenitic	quench hardened	180	14								
	austenitic-ferritic		230	15								
K Grey cast iron	perlitic/ferritic		180	16								
	perlitic (martensitic)		260	17								
K Cast iron with spheroidal graphite	ferritic		160	18								
	perlitic		250	19								
K Malleable cast iron	ferritic		130	20								
	perlitic		230	21								
N Aluminium wrought alloys	cannot be hardened		60	22	920	1100	1200	4	830	990	1080	4
	hardenable	hardened	100	23	555	660	720	4	500	595	650	4
	$\leq 12\% \text{ Si}$, cannot be hardened		75	24	370	440	480	4	335	400	435	4
	$\leq 12\% \text{ Si}$, hardenable	hardened	90	25	460	550	600	4	415	495	540	4
N Cast aluminium alloys	$> 12\% \text{ Si}$, cannot be hardened		130	26	140	165	180	4	125	150	165	4
	machining steel, PB > 1%		110	27	280	330	360	4	250	300	325	4
	CuZn, CuSnZn		90	28	325	385	420	4	295	350	380	4
N Copper and copper alloys (bronze/brass)	CuSn, Pb-free copper, electrolytic copper		100	29	280	330	360	4	250	300	325	4
	S Heat-resistant alloys	Fe-based alloys	annealed	200	30							
hardened			280	31								
Ni or Co base		annealed	250	32								
		hardened	350	33								
S Titanium alloys		cast	320	34								
		pure titanium	R_m 400	35								
S Titanium alloys		α and β alloys	hardened	R_m 1050	36							
		H Hardened steel		hardened and tempered	55 HRC	37						
hardened and tempered	60 HRC			38								
H Hard cast iron		cast	400	39								
		hardened and tempered	55 HRC	40								
X Non-metallic materials	Thermoplasts			41								
	Thermosetting plastics			42								
	Plastic, glass-fibre reinforced GFRP			43								
	Plastic, carbon fibre reinforced CFRP			44								
	Graphite			45								
	Wood			46								

Note: The given cutting values are guide values, which were determined under ideal conditions.
 The values have to be adapted in individual cases.
 Feed rate recommendations on page B444.
 For examples of material for cutting tool groups view page D22.

End mill – PM series

Material group	Composition / structure / heat treatment	Brinell hardness HB	Machining group	Starting values for cutting speed v_c [m/min]									
				PM-2R PM-4R					PM-4RL				
				Slot milling		Shoulder milling			Slot milling		Shoulder milling		
				\emptyset [mm]	a_p max	\emptyset [mm]	a_e max	\emptyset [mm]	a_p max	\emptyset [mm]	a_e max		
				$0 < x < 3$	$0,15 \times D$	$0 < x \leq 20$	$0,15 \times D$	$0 < x < 3$	$0,15 \times D$	$0 < x \leq 20$	$0,15 \times D$		
P Unalloyed steel	ca. 0,15 % C	annealed	125	1	165	220	300	1	150	200	265	1	
	ca. 0,45 % C	annealed	190	2	160	210	285	1	145	190	255	1	
	ca. 0,45 % C	tempered	250	3	120	155	210	1	105	140	190	1	
	ca. 0,75 % C	annealed	270	4	100	135	180	1	90	120	160	1	
	ca. 0,75 % C	tempered	300	5	95	125	165	1	85	110	150	1	
P Low-alloyed steel		annealed	180	6	125	165	225	1	115	150	200	1	
		tempered	275	7	100	135	180	1	90	120	160	1	
		tempered	300	8	95	125	165	1	85	110	150	1	
		tempered	350	9	90	115	160	1	80	105	140	1	
P High-alloyed steel and high-alloyed tool steel		annealed	200	10	120	155	210	1	105	140	190	1	
		hardened and tempered	325	11	90	120	160	1	80	110	145	1	
M Stainless steel	ferritic/martensitic	annealed	200	12	55	75	100	1	50	65	85	1	
	martensitic	tempered	240	13	50	65	85	1	45	60	75	1	
	austenitic	quench hardened	180	14	60	75	105	1	55	70	95	1	
	austenitic-ferritic		230	15	50	65	85	1	45	60	75	1	
K Grey cast iron	perlitic/ferritic		180	16	125	165	220	1	110	150	195	1	
	perlitic (martensitic)		260	17	100	135	180	1	90	120	160	1	
	ferritic		160	18	150	200	270	1	135	180	240	1	
	perlitic		250	19	120	155	210	1	105	140	190	1	
	ferritic		130	20	165	220	300	1	150	200	265	1	
K Cast iron with spheroidal graphite	perlitic		230	21	135	180	240	1	120	160	215	1	
	perlitic		230	21	135	180	240	1	120	160	215	1	
K Malleable cast iron	ferritic		130	20	165	220	300	1	150	200	265	1	
	perlitic		230	21	135	180	240	1	120	160	215	1	
N Aluminium wrought alloys	cannot be hardened		60	22									
	hardenable	hardened	100	23									
	$\leq 12\% \text{ Si}$, cannot be hardened		75	24									
	$\leq 12\% \text{ Si}$, hardenable	hardened	90	25									
N Cast aluminium alloys	$> 12\% \text{ Si}$, cannot be hardened		130	26									
	machining steel, PB> 1%		110	27									
	CuZn, CuSnZn		90	28									
N Copper and copper alloys (bronze/brass)	CuSn, Pb-free copper, electrolytic copper		100	29									
	Fe-based alloys	annealed	200	30									
	hardened		280	31									
S Heat-resistant alloys	Ni or Co bass	annealed	250	32									
	hardened		350	33									
	cast		320	34									
	pure titanium		R_m 400	35									
S Titanium alloys	α and β alloys	hardened	R_m 1050	36									
	hardened and tempered		55 HRC	37	85	110	145	1	70	95	125	1	
H Hardened steel	hardened and tempered		60 HRC	38									
	cast		400	39	115	145	190	1	95	125	165	1	
H Hardened cast iron	hardened and tempered		55 HRC	40									
X Non-metallic materials	Thermoplasts			41									
	Thermosetting plastics			42									
	Plastic, glass-fibre reinforced GFRP			43									
	Plastic, carbon fibre reinforced CFRP			44									
	Graphite			45									
	Wood			46									

Note: The given cutting values are guide values, which were determined under ideal conditions.
The values have to be adapted in individual cases.
Feed rate recommendations on page B240.
For examples of material for cutting tool groups view page D22.

End mill – UM/HPC/VSM series

Material group	Composition / structure / heat treatment		Brinell hardness HB	Machining group	Starting values for cutting speed v_c [m/min]										
					5501R38414GM (-R) 5502R38414GM (-R) 5602R38414GM (-R)				UM-4E UM-4E-W UM-4R						
					Slot milling		Shoulder milling		Slot milling		Shoulder milling				
					\varnothing [mm]	a_p max	\varnothing [mm]	a_e max	\varnothing [mm]	a_p max	\varnothing [mm]	a_e max			
$0 < x < 3$		$0 < x < 3$		$0 < x < 3$		$0 < x < 3$									
$3 \leq x < 12$		$3 \leq x < 20$		$3 \leq x < 12$		$3 \leq x < 20$									
$12 \leq x \leq 20$		$15 \times D$		$12 \leq x \leq 20$		$15 \times D$									
				KMG405				KMG405							
				a_e / D				a_e / D							
1/1		1/2		1/10		f-group		1/1		1/2		1/10		f-group	
P Unalloyed steel	ca. 0,15 % C	annealed	125	1	250	300	380	9	250	300	380	9			
	ca. 0,45 % C	annealed	190	2	240	285	365	9	240	285	365	9			
	ca. 0,45 % C	tempered	250	3	175	210	270	9	175	210	270	9			
	ca. 0,75 % C	annealed	270	4	150	180	230	9	150	180	230	9			
	ca. 0,75 % C	tempered	300	5	140	165	210	9	140	165	210	9			
P Low-alloyed steel		annealed	180	6	190	225	285	9	190	225	285	9			
		tempered	275	7	150	180	230	9	150	180	230	9			
		tempered	300	8	140	165	210	9	140	165	210	9			
		tempered	350	9	130	160	200	9	130	160	200	9			
P High-alloyed steel and high-alloyed tool steel		annealed	200	10	175	210	270	9	175	210	270	9			
		hardened and tempered	325	11	135	160	205	9	135	160	205	9			
M Stainless steel	ferritic/martensitic	annealed	200	12	80	100	125	9	80	100	125	9			
	martensitic	tempered	240	13	70	85	110	9	70	85	110	9			
	austenitic	quench hardened	180	14	85	105	130	9	85	105	130	9			
	austenitic-ferritic		230	15	70	85	110	9	70	85	110	9			
K Grey cast iron	perlitic/ferritic		180	16	185	220	280	9	185	220	280	9			
	perlitic (martensitic)		260	17	150	180	230	9	150	180	230	9			
K Cast iron with spheroidal graphite	ferritic		160	18	225	270	345	9	225	270	345	9			
	perlitic		250	19	175	210	270	9	175	210	270	9			
K Malleable cast iron	ferritic		130	20	250	300	380	9	250	300	380	9			
	perlitic		230	21	200	240	305	9	200	240	305	9			
N Aluminium wrought alloys	cannot be hardened		60	22											
	hardenable	hardened	100	23											
	$\leq 12\% \text{ Si}$, cannot be hardened		75	24											
	$\leq 12\% \text{ Si}$, hardenable	hardened	90	25											
N Cast aluminium alloys	$> 12\% \text{ Si}$, cannot be hardened		130	26											
	machining steel, PB> 1%		110	27											
	CuZn, CuSnZn		90	28											
N Copper and copper alloys (bronze/brass)	CuSn, Pb-free copper, electrolytic copper		100	29											
	S Heat-resistant alloys	Fe-based alloys	annealed	200	30										
		hardened	280	31											
S Ni or Co bass	annealed	250	32												
	hardened	350	33												
	cast	320	34												
S Titanium alloys	pure titanium		R_m 400	35											
	α and β alloys	hardened	R_m 1050	36											
H Hardened steel		hardened and tempered	55 HRC	37	115	140	175	9	115	140	175	9			
		hardened and tempered	60 HRC	38											
H Hard cast iron		cast	400	39	135	165	205	9	135	165	205	9			
H Hardened cast iron		hardened and tempered	55 HRC	40											
X Non-metallic materials	Thermoplasts			41											
	Thermosetting plastics			42											
	Plastic, glass-fibre reinforced GFRP			43											
	Plastic, carbon fibre reinforced CFRP			44											
	Graphite			45											
	Wood			46											

Note: The given cutting values are guide values, which were determined under ideal conditions.

The values have to be adapted in individual cases.

Feed rate recommendations on page B240.

For examples of material for cutting tool groups view page D22.

Deburring cutters – FM series

Material group	Composition / structure / heat treatment	Brinell hardness HB	Machining group	Starting values for cutting speed v_c [m/min]					
				5501 / 5601 5501 / 5601 5601					
				KMG303					
				a_e / D					
				1/1	1/2	1/10	f-group		
P Unalloyed steel	ca. 0,15 % C	annealed	125	1			230	11	
	ca. 0,45 % C	annealed	190	2			220	11	
	ca. 0,45 % C	tempered	250	3			165	11	
	ca. 0,75 % C	annealed	270	4			140	11	
	ca. 0,75 % C	tempered	300	5			130	11	
P Low-alloyed steel		annealed	180	6			175	11	
		tempered	275	7			140	11	
		tempered	300	8			130	11	
		tempered	350	9			120	11	
P High-alloyed steel and high-alloyed tool steel		annealed	200	10			165	11	
		hardened and tempered	325	11			125	11	
M Stainless steel	ferritic/martensitic	annealed	200	12			75	11	
	martensitic	tempered	240	13			65	11	
	austenitic	quench hardened	180	14			80	11	
	austenitic-ferritic		230	15			65	11	
K Grey cast iron	perlitic/ferritic		180	16			170	11	
	perlitic (martensitic)		260	17			140	11	
K Cast iron with spheroidal graphite	ferritic		160	18			210	11	
	perlitic		250	19			165	11	
K Malleable cast iron	ferritic		130	20			230	11	
	perlitic		230	21			185	11	
N Aluminium wrought alloys	cannot be hardened		60	22			1200	11	
	hardenable	hardened	100	23			720	11	
	$\leq 12\% \text{ Si}$, cannot be hardened		75	24			480	11	
	$\leq 12\% \text{ Si}$, hardenable	hardened	90	25			600	11	
N Cast aluminium alloys	$> 12\% \text{ Si}$, cannot be hardened		130	26			180	11	
	machining steel, PB> 1%		110	27			360	11	
	CuZn, CuSnZn		90	28			420	11	
N Copper and copper alloys (bronze/brass)	CuSn, Pb-free copper, electrolytic copper		100	29			360	11	
	S Heat-resistant alloys	Fe-based alloys	annealed	200	30				
			hardened	280	31				
Ni or Co bass		annealed	250	32					
		hardened	350	33					
S Titanium alloys	cast	320	34						
	pure titanium		R_m 400	35					
S α and β alloys	hardened		R_m 1050	36					
	H Hardened steel	hardened and tempered	55 HRC	37					
hardened and tempered		60 HRC	38						
H Hard cast iron	cast	400	39						
H Hardened cast iron	hardened and tempered	55 HRC	40						
X Non-metallic materials	Thermoplasts			41					
	Thermosetting plastics			42					
	Plastic, glass-fibre reinforced GFRP			43					
	Plastic, carbon fibre reinforced CFRP			44					
	Graphite			45					
	Wood			46					

Note: The given cutting values are guide values, which were determined under ideal conditions.
 The values have to be adapted in individual cases.
 Feed rate recommendations on page B444.
 For examples of material for cutting tool groups view page D22.

Recommend feed rate

Solid carbide milling group 1 – Square shoulder mills PM series

	a_e/D	Feed rate per cutting edge (f_z) [mm]																				
		Ø0,5	Ø0,8	Ø 1	Ø 2	Ø 3	Ø 4	Ø 5	Ø 6	Ø 8	Ø 10	Ø 12	Ø 14	Ø 16	Ø 18	Ø 20						
P	1/1	0,01	0,02	0,02	0,02	0,02	0,02	0,02	0,03	0,03	0,05	0,07	0,08	0,08	0,09	0,09	0,10					
	1/2	0,01	0,03	0,03	0,03	0,03	0,03	0,03	0,04	0,04	0,06	0,09	0,10	0,10	0,12	0,12	0,13					
	1/10	0,02	0,05	0,05	0,05	0,05	0,05	0,05	0,07	0,07	0,09	0,14	0,16	0,16	0,18	0,18	0,20					
M	1/1	0,01	0,02	0,02	0,02	0,02	0,02	0,02	0,03	0,03	0,04	0,05	0,06	0,06	0,07	0,07	0,08					
	1/2	0,01	0,02	0,02	0,02	0,02	0,02	0,02	0,04	0,04	0,05	0,07	0,08	0,08	0,10	0,10	0,11					
	1/10	0,02	0,04	0,04	0,04	0,04	0,04	0,04	0,05	0,05	0,07	0,11	0,13	0,13	0,15	0,15	0,16					
K	1/1	0,01	0,02	0,02	0,02	0,02	0,02	0,03	0,03	0,05	0,07	0,08	0,08	0,09	0,09	0,10						
	1/2	0,01	0,03	0,03	0,03	0,03	0,03	0,04	0,04	0,06	0,09	0,10	0,10	0,12	0,12	0,13						
	1/10	0,02	0,05	0,05	0,05	0,05	0,05	0,07	0,07	0,09	0,14	0,16	0,16	0,18	0,18	0,20						
H	1/1	0,01	0,02	0,02	0,02	0,02	0,02	0,03	0,03	0,04	0,05	0,06	0,06	0,07	0,07	0,08						
	1/2	0,01	0,02	0,02	0,02	0,02	0,02	0,04	0,04	0,05	0,07	0,08	0,08	0,10	0,10	0,11						
	1/10	0,02	0,04	0,04	0,04	0,04	0,04	0,05	0,05	0,07	0,11	0,13	0,13	0,15	0,15	0,16						

Note: The given cutting values are guide values, which were determined under ideal conditions.
The values have to be adapted in individual cases.

Solid carbide milling group 2 – Square shoulder mills GM series

	a_e/D	Feed rate per cutting edge (f_z) [mm]																				
		Ø0,5	Ø0,8	Ø 1	Ø 2	Ø 3	Ø 4	Ø 5	Ø 6	Ø 8	Ø 10	Ø 12	Ø 14	Ø 16	Ø 18	Ø 20						
P	1/1	0,01	0,02	0,02	0,02	0,02	0,02	0,02	0,03	0,03	0,04	0,06	0,07	0,07	0,08	0,08	0,09					
	1/2	0,01	0,03	0,03	0,03	0,03	0,03	0,03	0,04	0,04	0,05	0,08	0,09	0,09	0,10	0,10	0,12					
	1/10	0,02	0,04	0,04	0,04	0,04	0,04	0,04	0,06	0,06	0,08	0,12	0,14	0,14	0,16	0,16	0,18					
M	1/1	0,01	0,02	0,02	0,02	0,02	0,02	0,02	0,02	0,03	0,05	0,06	0,06	0,06	0,06	0,07						
	1/2	0,01	0,02	0,02	0,02	0,02	0,02	0,02	0,03	0,03	0,04	0,06	0,07	0,07	0,08	0,08	0,09					
	1/10	0,02	0,03	0,03	0,03	0,03	0,03	0,03	0,05	0,05	0,06	0,10	0,11	0,11	0,13	0,13	0,15					
K	1/1	0,01	0,02	0,02	0,02	0,02	0,02	0,03	0,03	0,04	0,06	0,07	0,07	0,08	0,08	0,09						
	1/2	0,01	0,03	0,03	0,03	0,03	0,03	0,04	0,04	0,05	0,08	0,09	0,09	0,10	0,10	0,12						
	1/10	0,02	0,04	0,04	0,04	0,04	0,04	0,06	0,06	0,08	0,12	0,14	0,14	0,16	0,16	0,18						

Note: The given cutting values are guide values, which were determined under ideal conditions.
The values have to be adapted in individual cases.

Solid carbide milling group 3 – Square shoulder mills HM series

	a_e/D	Feed rate per cutting edge (f_z) [mm]																				
		Ø0,5	Ø0,8	Ø 1	Ø 2	Ø 3	Ø 4	Ø 5	Ø 6	Ø 8	Ø 10	Ø 12	Ø 14	Ø 16	Ø 18	Ø 20						
H	1/1	0,01	0,02	0,02	0,02	0,02	0,02	0,02	0,02	0,03	0,05	0,06	0,06	0,06	0,06	0,07						
	1/2	0,01	0,02	0,02	0,02	0,02	0,02	0,02	0,03	0,03	0,04	0,06	0,07	0,07	0,08	0,08	0,09					
	1/10	0,02	0,03	0,03	0,03	0,03	0,03	0,03	0,05	0,05	0,06	0,10	0,11	0,11	0,13	0,13	0,15					

Note: The given cutting values are guide values, which were determined under ideal conditions.
The values have to be adapted in individual cases.

Solid carbide milling group 4 – Square shoulder mills AL/NM series

	a_e/D	Feed rate per cutting edge (f_z) [mm]																				
		Ø0,5	Ø0,8	Ø 1	Ø 2	Ø 3	Ø 4	Ø 5	Ø 6	Ø 8	Ø 10	Ø 12	Ø 14	Ø 16	Ø 18	Ø 20						
N	1/1	0,02	0,03	0,03	0,03	0,03	0,03	0,03	0,05	0,05	0,06	0,09	0,11	0,11	0,12	0,12	0,14					
	3/4	0,02	0,04	0,04	0,04	0,04	0,04	0,06	0,06	0,08	0,12	0,14	0,14	0,16	0,16	0,18						
	1/10	0,03	0,06	0,06	0,06	0,06	0,06	0,09	0,09	0,12	0,19	0,22	0,22	0,25	0,25	0,28						
	1/20	0,04	0,08	0,08	0,08	0,08	0,08	0,12	0,12	0,16	0,23	0,27	0,27	0,31	0,31	0,35						

Note: The given cutting values are guide values, which were determined under ideal conditions.
The values have to be adapted in individual cases.

Recommend feed rate

Solid carbide milling group 9 – Square shoulder mills UM series HSC/HPC

	a _e / D	Feed rate per cutting edge (f _z) [mm]																
		Ø 4	Ø 5	Ø 6	Ø 8	Ø 10	Ø 12	Ø 14	Ø 16	Ø 18	Ø 20							
P	1/1	0,06	0,06	0,06	0,07	0,07	0,07	0,07	0,08	0,08	0,08							
	1/2	0,08	0,08	0,08	0,09	0,09	0,09	0,09	0,10	0,10	0,10							
	1/10	0,14	0,14	0,16	0,18	0,22	0,25	0,27	0,3	0,32	0,36							
M	1/1	0,05	0,05	0,05	0,05	0,05	0,05	0,05	0,06	0,06	0,06							
	1/2	0,06	0,06	0,06	0,07	0,07	0,07	0,07	0,08	0,08	0,08							
	1/10	0,10	0,10	0,10	0,12	0,12	0,14	0,16	0,16	0,18	0,18							
K	1/1	0,06	0,06	0,06	0,07	0,07	0,07	0,07	0,08	0,08	0,08							
	1/2	0,08	0,08	0,08	0,09	0,09	0,09	0,09	0,10	0,10	0,10							
	1/10	0,14	0,14	0,16	0,18	0,22	0,25	0,27	0,3	0,32	0,36							
H	1/1	0,045	0,045	0,045	0,053	0,053	0,053	0,053	0,06	0,06	0,06							
	1/2	0,06	0,06	0,06	0,07	0,07	0,07	0,07	0,08	0,08	0,08							
	1/10	0,10	0,10	0,10	0,12	0,12	0,14	0,16	0,16	0,18	0,18							

Note: The given cutting values are guide values, which were determined under ideal conditions.
The values have to be adapted in individual cases.

Solid carbide milling group 10 – Square shoulder mills VSM series

	a _e / D	Feed rate per cutting edge (f _z) [mm]																
		Ø 4	Ø 5	Ø 6	Ø 8	Ø 10	Ø 12	Ø 14	Ø 16	Ø 18	Ø 20							
P	1/1	0,03	0,04	0,05	0,05	0,05	0,05	0,06	0,06	0,07	0,08							
	1/2	0,04	0,06	0,07	0,07	0,07	0,07	0,08	0,09	0,10	0,11							
	1/10	0,05	0,08	0,09	0,09	0,09	0,09	0,11	0,12	0,14	0,15							
M	1/1	0,02	0,03	0,04	0,04	0,04	0,04	0,04	0,05	0,05	0,06							
	1/2	0,03	0,05	0,05	0,05	0,05	0,05	0,06	0,07	0,08	0,08							
	1/10	0,04	0,06	0,07	0,07	0,07	0,07	0,08	0,09	0,10	0,11							
S	1/1	0,02	0,03	0,04	0,04	0,04	0,04	0,04	0,05	0,05	0,06							
	1/2	0,03	0,05	0,05	0,05	0,05	0,05	0,06	0,07	0,08	0,08							
	1/10	0,04	0,06	0,07	0,07	0,07	0,07	0,08	0,09	0,10	0,11							

Note: The given cutting values are guide values, which were determined under ideal conditions.
The values have to be adapted in individual cases.

Solid carbide milling group 11 – Deburring cutters FM series

	a _e / D	Feed rate per cutting edge (f _z) [mm]																
		Ø 3	Ø 4	Ø 5	Ø 6	Ø 8	Ø 10	Ø 12	Ø 14	Ø 16	Ø 18	Ø 20						
P	1/1																	
	1/2																	
	1/10	0,02	0,02	0,03	0,03	0,04	0,06	0,07	0,07	0,08	0,08	0,09						
M	1/1																	
	1/2																	
	1/10	0,02	0,02	0,02	0,02	0,03	0,05	0,06	0,06	0,06	0,06	0,07						
K	1/1																	
	1/2																	
	1/10	0,02	0,02	0,03	0,03	0,04	0,06	0,07	0,07	0,08	0,08	0,09						
N	1/1																	
	1/2																	
	1/10	0,03	0,03	0,05	0,05	0,06	0,09	0,11	0,11	0,12	0,12	0,14						

Note: The given cutting values are guide values, which were determined under ideal conditions.
The values have to be adapted in individual cases.

Technical information

Trouble shooting – milling

B448

Technical information – milling

B449-B460

Form nonstandard order – milling

B461-B462

B

A

Turning

B

Milling

C

Drilling

D

Technical
Information

E

Index

Trouble shooting – indexable milling cutters

See figure	Type of wear	Effects	Reason	Countermeasure
1+2	Flank wear	<ul style="list-style-type: none"> – Bad surface quality and dimensional stability – Increase of cutting force 	<ul style="list-style-type: none"> – Grade not wear-resistant enough – Cutting speed too high – Clearance angle too small – Feed rate too low 	<ul style="list-style-type: none"> – Grade with higher wear-resistance – Reduce cutting speed – Increase clearance angle – Reduce feed rate
3	Crater wear	<ul style="list-style-type: none"> – Bad surface quality and chip control 	<ul style="list-style-type: none"> – Grade not wear-resistant enough – Cutting speed too high – Feed rate too low 	<ul style="list-style-type: none"> – Grade with higher wear-resistance – Reduce cutting speed – Reduce feed rate
4	Chipping	<ul style="list-style-type: none"> – Unstable tool life – Sudden breakage of cutting edge 	<ul style="list-style-type: none"> – Grade too hard – Feed rate too high – Cutting edge not stable enough – Stability of the holder or tension insufficient 	<ul style="list-style-type: none"> – Grade with higher toughness – Reduce feed rate – Change honing of cutting edge – Use a more stable tool holder
5	Breakage	<ul style="list-style-type: none"> – Increase of cutting force – Bad surface quality and dimensional stability 	<ul style="list-style-type: none"> – Grade too hard – Feed rate too high – Cutting edge not stable enough – Stability of the holder or tension insufficient 	<ul style="list-style-type: none"> – Grade with higher toughness – Reduce feed rate – Change honing of cutting edge – Use a more stable tool holder
6	Plastic deformation	<ul style="list-style-type: none"> – Bad dimensional stability – Damage to cutting edge 	<ul style="list-style-type: none"> – Grade not wear-resistant enough – Cutting speed too high – Cutting depth and/or feed rate too high – Temperature on the cutting edge too high 	<ul style="list-style-type: none"> – Grade with higher toughness – Reduce cutting speed – Reduce cutting depth and feed rate – Grade with higher heat-resistance
7	Welding	<ul style="list-style-type: none"> – Increase of cutting force – Bad surface quality 	<ul style="list-style-type: none"> – Cutting speed too low – Cutting edge not sharp enough – Grade not suitable 	<ul style="list-style-type: none"> – Increase cutting speed – Increase rake angle – Use a more suitable grade
8	Thermal cracks	<ul style="list-style-type: none"> – Breakage due to thermal interaction, often caused when cutting is interrupted (milling) 	<ul style="list-style-type: none"> – Temperature fluctuation when machining – Grade too hard 	<ul style="list-style-type: none"> – Dry machining – Grade with higher toughness
9	Notch wear	<ul style="list-style-type: none"> – Burr formation – Increase of cutting force 	<ul style="list-style-type: none"> – Damage through chips (jagged edges) – Feed rate and cutting speed too high 	<ul style="list-style-type: none"> – Grade with higher wear-resistance – Increase rake angle to get a sharper cutting edge – Reduce cutting speed
10	Flaking (coating)	<ul style="list-style-type: none"> – Often appears when machining hardened materials or caused by vibration 	<ul style="list-style-type: none"> – Cutting edge adhesion and chipping – Bad chip removal 	<ul style="list-style-type: none"> – Increase rake angle to get a sharper cutting edge – Chip breaker with bigger chip space

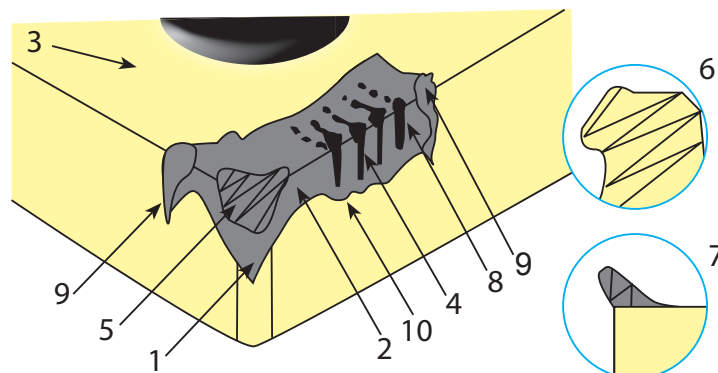

A

Drehen

B

Fräsen

C

Bohren

D

Technische Information

E

Index

Indexable milling

Difference between up-milling and down-milling

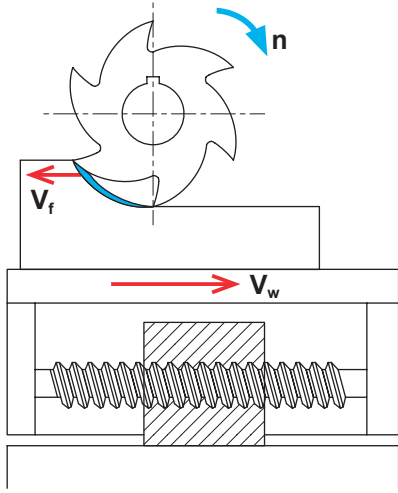

Up-milling

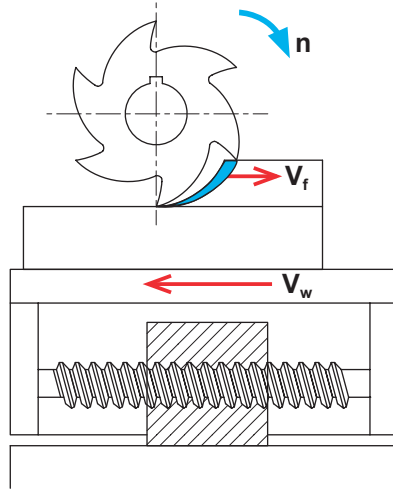

Down-milling

V_f Feed rate tool
 V_w Feed rate work piece
 n Rotation

Up-milling: the feed direction of the work piece is opposite to that of the milling rotation at the connecting position.

Down-milling: the feed direction of the work piece is the same as that of the milling rotation at the connecting position.

Advantages and disadvantages

Direction	Advantages	Disadvantages
Up-milling	<ul style="list-style-type: none"> - Prevents hooking of tool - More smooth cut 	<ul style="list-style-type: none"> - Bigger stress on cutting edge - Shorter tool life
Down-milling	<ul style="list-style-type: none"> - Higher tool life - Less thermal stress 	<ul style="list-style-type: none"> - Hooking of tool possible

A

Turning

B

Milling

C

Drilling

D

Technical Information

E

Index

A

Indexable milling



Turning

Pitch selection

The pitch is the distance between one point on one cutting edge and the same point on the next edge. Milling cutters are mainly classified into wide, normal and fine pitches.

B

Milling

Operational stability		
L (low)	M (medium)	H (high)
Wide pitch	Normal pitch	Fine pitch
		
When the milling width is equal to the diameter of the cutter, the machining system is stable and main power of machine is sufficient, selecting a wide pitch can achieve high productive efficiency.	General milling function and multiple mixed productions.	When the milling width is less than the diameter of cutter, cutting by maximum edges can achieve high productive efficiency.

C

Drilling

Approach angle

The approach angle is composed by insert. Tool body, chip thickness, cutting forces and tool life are affected especially by the approach angle. Decreasing the approach angle reduces chip thickness and spreads the cutting area between cutting edge and work piece for a given feed rate. A smaller approach angle also guarantees stable entering or exiting the work piece, to protect the cutting edge and extend tool life. However this will increase higher axial cutting forces on the work piece, thus it is not suitable for machining thin work pieces such as thin plates.

D

Technical Information

Approach angle	Feed rate per tooth	Max. cutting depth
90°	f_z	$h_{ex} = f_z \times \sin \kappa_r$
75°		$h_{ex} = 0,96 \times f_z$
60°		$h_{ex} = 0,86 \times f_z$
45°		$h_{ex} = 0,707 \times f_z$
Round		$h_{ex} = \frac{\sqrt{iC^2 \times (iC - 2a_p)^2}}{iC} \times f_z$

E

Index

Indexable milling

General formulas

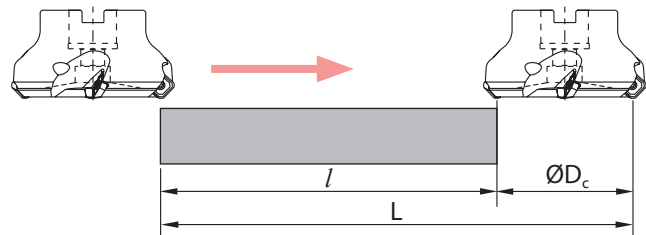
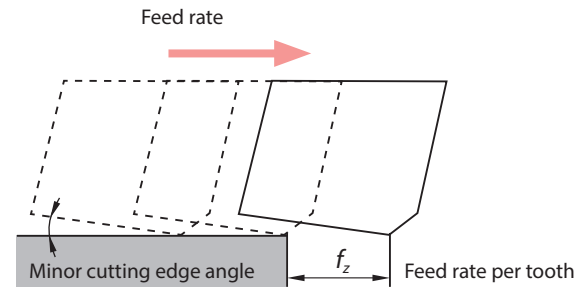
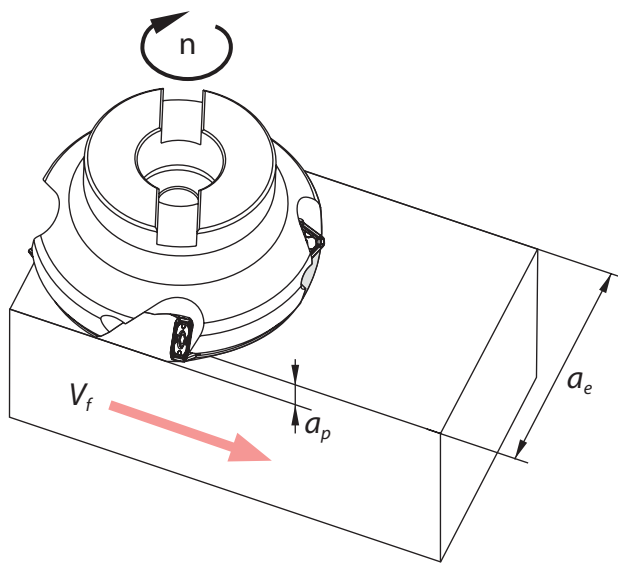

V_c : Feed rate [m/min]
 D_c : Nominal diameter of milling tool [mm]
 n : Spindle speed [u/min]
 z_n : Number of teeth
 Q : Metal removal rate [cm³/min]

V_f : Feed rate of worktable (feed speed) [mm/min]
 f_z : Feed rate per tooth [mm/z]
 π : ~3,14
 T_c : Machining time [min]
 f_n : Feed rate per revolution [mm/u]

Cutting speed	$V_c = \frac{\pi \times D_c \times n}{1000} \text{ [m/min]}$
Spindle speed	$n = \frac{1000 \times V_c}{\pi \times D_c} \text{ [rev/min]}$
Feed rate of work table	$V_f = f_z \times n \times z_n \text{ [mm/min]}$
Feed rate per tooth	$f_z = \frac{V_f}{n \times Z_n} \text{ [mm/z]}$
Feed rate per revolution	$f_n = \frac{V_f}{n} \text{ [mm/rev]}$
Machining time	$T_c = \frac{1000 \times V_c}{\pi \times D_c} \text{ [min]}$
Metal removal rate	$Q = \frac{a_p \times a_e \times V_f}{1000} \text{ [cm}^3\text{/min]}$

A

Turning

B

Milling

C

Drilling

D

Technical Information

E

Index

Indexable milling

Function of angles when face milling

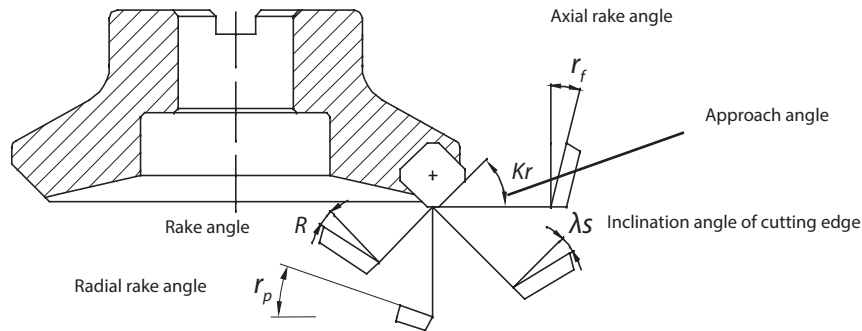

Main angles

Angle	Feature	Effect		
Axial rake angle r_f	Influences chip direction	Negative angle, good chip removal		
Radial rake angle r_p	Influences cutting edge sharpness	Positive angle, good cutting performance		
Approach angle Kr	Influences chip thickness	$Kr \uparrow$, chip thickness \uparrow , $Kr \downarrow$, chip thickness \downarrow ;		
Rake angle R	Influences cutting force	Poor cutting performance, stable cutting edge	$(-) \leftarrow 0 \rightarrow (+)$	Good cutting performance, unstable cutting edge
Inclination angle λ_s	Influences chip flow direction	Poor cutting performance, stable cutting edge	$(-) \leftarrow 0 \rightarrow (+)$	Good cutting performance, unstable cutting edge

Combination of different rake angles

		Double positive	Double negative	Positive/Negative
Negative rake angle				
Neutral angle				
Positive angle				
Axial rake angle r_f		+	-	+
Radial rake angle r_p		+	-	-
Application field	P	√		√
	M	√		√
	K		√	√
	N	√		
	S	√		√

Indexable milling

Cutting performances of different approach angles

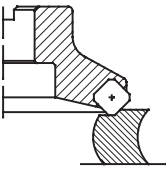
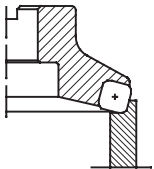
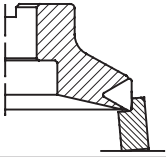
Approach angle	Depiction	Explanation
45°		Axial force is largest. It will bend when machining thin-wall work piece, and reduces the precision of work piece. It is benefit to avoid fringe breakage of work piece when machining cast iron.
75°		The main purpose is to resolve the radial cutting force, it is often used for general face milling.
90°		The axial force is zero in theory, suitable for milling thin plate workpiece.

Inserts with wiper

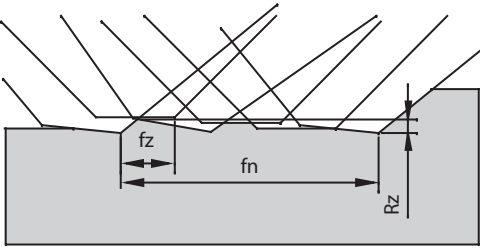
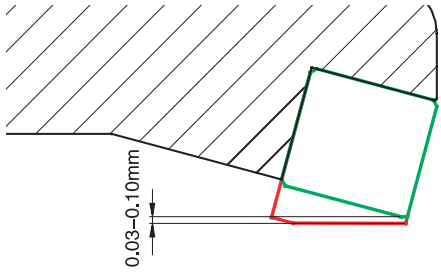
Using standard inserts	Using inserts with wiper
	
Normal surface quality	High surface quality

The wiper insert must protrude below the other inserts by 0.03–0.10 mm at axial direction, only that the wiping function can take into effect. Generally speaking, a cutter can assemble only one wiper insert. If the diameter of cutter is much bigger or cutter's feed rate per revolution is bigger than the length of wiper edge, 2 to 3 wiper inserts can be assembled.

Cutting width

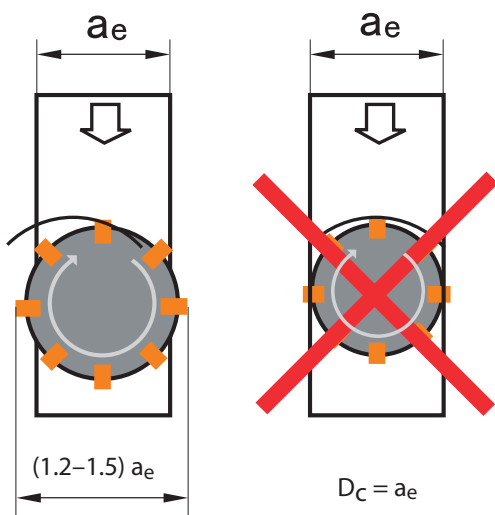

Generally speaking, the relation between cutting width and tool cutting diameter is $D_c = (1.2-1.5) a_e$.

In the machining practice, it needs to avoid coincidence of tool center and workpiece center as much as possible.

D_c : Tool diameter
 a_e : Lateral infeed

A

Turning

B

Milling

C

Drilling

D

Technical Information

E

Index

Indexable milling

Plunging and circular milling with insert APKT

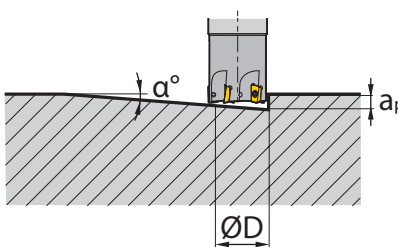
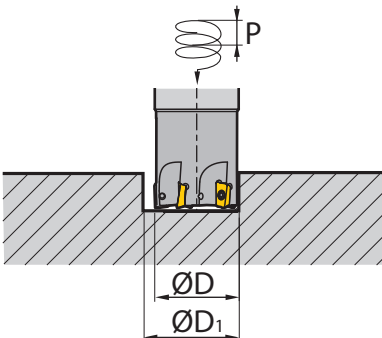
		Plunging		Circular milling	
					
		$L_m = \frac{a_p}{\tan \alpha}$ α: Plunge angle		$P = \tan \alpha \times \pi \times D_1$ α: Helical angle	
Insert	Diameter ØD [mm]	Max. cutting depth a _p [mm]	Max. plunge angle α°	Min. diameter ØD ₁ [mm]	Max. diameter [mm]
AP**11**	16	10	10	20	30
	20	10	5	28	38
	25	10	4	40	48
	32	10	3	56	60
	40	10	2	70	76

Reduce the feed rate when plunging and circular milling.
 For drilling operations (axial) set the feed rate under 0.2mm.
 „Attention“ – drilling can form long chips.

Indexable milling

Plunging and circular milling with insert WPGT or SDMT

Approx. programmed radius

Insert	approx. R [mm]	Residual material K [mm]
WPGT050315ZSR	2	0,5
WPGT060415ZSR	2,5	0,7
WPGT080615ZSR	2,5	0,7
WPGT090725ZSR	4,5	1,2
SDMT06T208	1,6	0,5
SDMT09T312	2,5	0,87
SDMT120412	4,0	0,93
SDMT150620	4,0	1,38

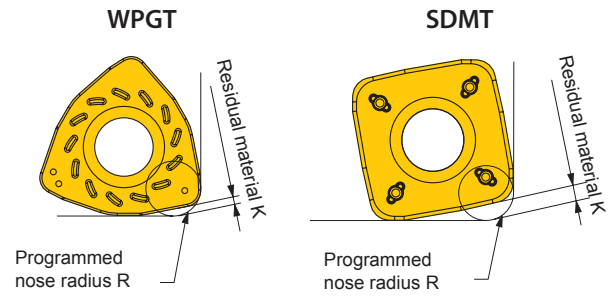

Insert WPGT

Insert	Diameter ØD [mm]	Plunging		Circular milling	
		Max. cutting depth a_p [mm]	Max. plunge angle α°	Min. diameter $\text{Ø}D_1$ [mm]	Max. diameter [mm]
WP**05**	20	1.5	12	24	37
WP**06**	25	1.5	8.8	31	47
	32	1.5	5	45	61
	40	1.5	3.2	61	77
	50	1.5	2.8	81	97
WP**08**	40	1.5	9	52	77
	50	1.5	5.4	71	97
	63	1.5	4.3	97	123
	80	1.5	2.9	131	157
	100	1.5	2.1	171	197
	125	1.5	1.3	221	247
WP**09**	160	1.5	1.1	291	317
	50	3.0	7.2	70	96
	63	3.0	4.5	96	122
	80	3.0	2.8	130	156
	100	3.0	2.2	170	196
	125	3.0	1.6	220	246
	160	3.0	1.2	290	316

Reduce the feed rate when plunging and circular milling.
 For drilling operations (axial) set the feed rate under 0.2 mm.
 „Attention“ – drilling can form long chips.

Indexable milling

Insert SDMT

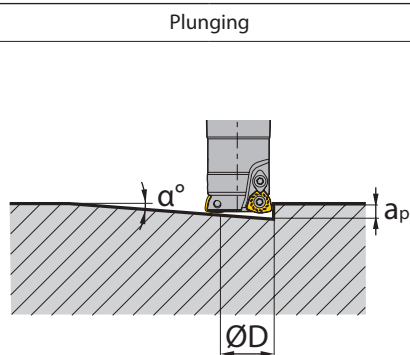

$$L_m = \frac{a_p}{\tan \alpha}$$

α : Plunge angle

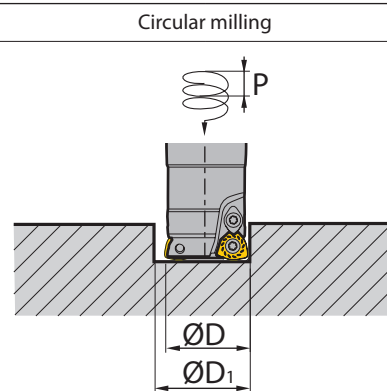

$$P = \tan \alpha \times \pi \times D_1$$

α : Helix angle

Insert	Diameter ØD [mm]	Max. cutting depth a_p [mm]	Max. plunge angle α°	Min. diameter ØD ₁ [mm]	Max. diameter [mm]
SD**06**	20	0.8	3.6	30	38
	25	0.8	2.8	40	48
	32	0.8	1.6	52	60
	40	0.8	1.1	70	78
	50	0.8	0.8	90	98
	63	0.8	0.7	114	122
SD**09**	25	1.4	6.5	34	48
	32	1.4	4.5	48	62
	35	1.4	3.6	54	68
	50	1.4	1.8	84	98
	63	1.4	1.3	110	124
SD**12**	32	1.8	10.4	44	60
	40	1.8	5.7	60	76
	50	1.8	3.5	80	96
	63	1.8	2.5	106	122
	80	1.8	1.6	140	156
	100	1.8	1.2	180	196
SD**15**	40	2.2	7.3	54	76
	80	2.2	1.4	134	156
	100	2.2	1.0	174	196
	125	2.2	0.9	234	246
	160	2.2	0.6	304	316

Reduce the feed rate when plunging and circular milling.
For drilling operations (axial) set the feed rate under 0,2mm.
„Attention“ – drilling can form long chips.

Solid carbide mills

Terminology

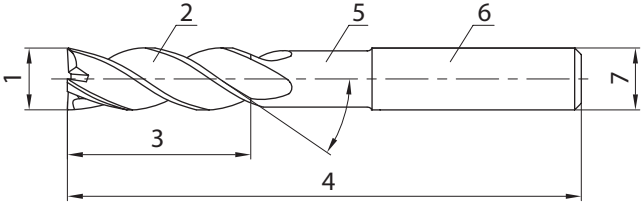
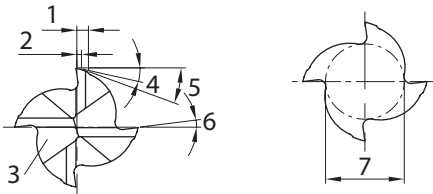
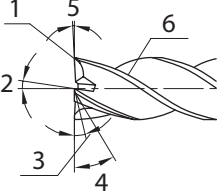
<p>A</p>		<ol style="list-style-type: none"> 1. Cutting edge diameter 2. Chip pocket 3. Length of cutting edge 4. Total length 5. Neck 6. Shank 7. Shank diameter
<p>B</p>		<ol style="list-style-type: none"> 1. Chamfer width, main cutting edge 2. Chamfer width, diameter 3. Neck, front side 4. Primary radial clearance angle 5. Secondary radial clearance angle 6. Radial rake angle 7. Axial main cutting edge 8. Core diameter
<p>C</p>		<ol style="list-style-type: none"> 1. Cutting edge 2. Axial rake angle 3. Primary axial clearance angle 4. Secondary axial clearance angle 5. Inclination angle 6. Radial cutting edge

Teeth, chip pocket and tool rigidity

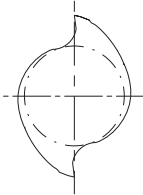
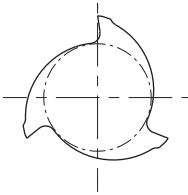
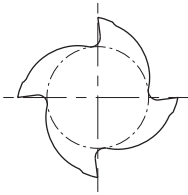
Teeth	2 flutes	3 flutes	4 flutes
Cross section			
Cutting edge ratio	54%	56%	60%
Advantages	<ul style="list-style-type: none"> - Large chip pocket - Good chip removal 	<ul style="list-style-type: none"> - Good chip removal - Good surface quality 	<ul style="list-style-type: none"> - Good rigidity - Good surface
Application	<ul style="list-style-type: none"> - Slot milling - Square shoulder milling - Drilling 	<ul style="list-style-type: none"> - Slot milling - Square shoulder milling - Finishing 	<ul style="list-style-type: none"> - Slot milling (flat) - Square shoulder milling - Finishing

Length of cutting edge (overhang) and cutting diameter

The shorter the overhang, the stronger the rigidity. Thus isn't easy to generate. Bend and vibration in the cutting process may occur.

Length (overhang) increases by 1 time, the deflection degree (f) will be 8 times of the former one.

**Reduce the overhang by 20 %
the deflection degree (f) will decrease by 50 %**

**Increase the diameter by 20 %
the deflection degree (f) will decrease by 50 %**

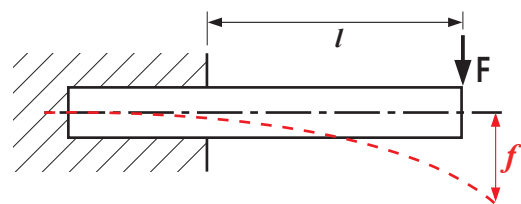

$$f = \frac{F \times l^3}{3 \times E \times I} = \frac{F \times l^3 \times 64}{3 \times E \times I}$$

Solid carbide mills

Machining strategy – HPC/UM (HSC) milling cutters

HPC = High Performance Cutting

Machining with significantly increased metal removal rate through higher cutting speeds and feed rates compared with conventional machine cutting processes.

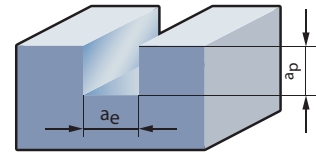

Full-slot milling

A

Turning

B

HSC (UM) = High Speed Cutting

High cutting speeds and feed rates in combination with low cutting depths lead to lower chip thickness as in normal machining.

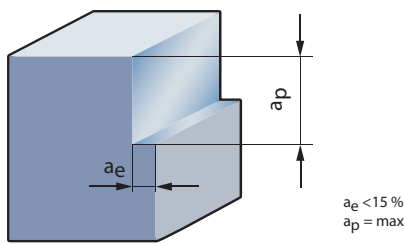

Profiling

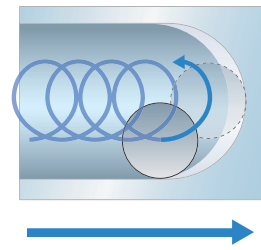

Trochoidal milling

Milling

C

Drilling

The UM milling cutter is specifically optimised for HSC machining.

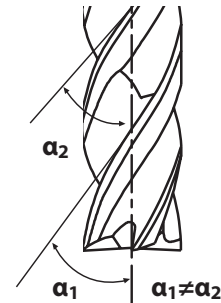
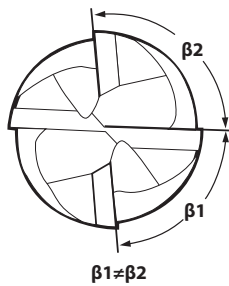

High metal removal rates can be realised with this tool.

Especially on highly dynamic machines with optimised tool paths this milling cutter shows its full potential.

D

Technical Information

E

Index

Solid carbide mills

HSC strategy

It's important to use the right strategy. When programming make sure the width of cut is kept. The width of cut is usually not higher than 15%. Regarding the depth of cut, the total length of the cutting edge can be used.

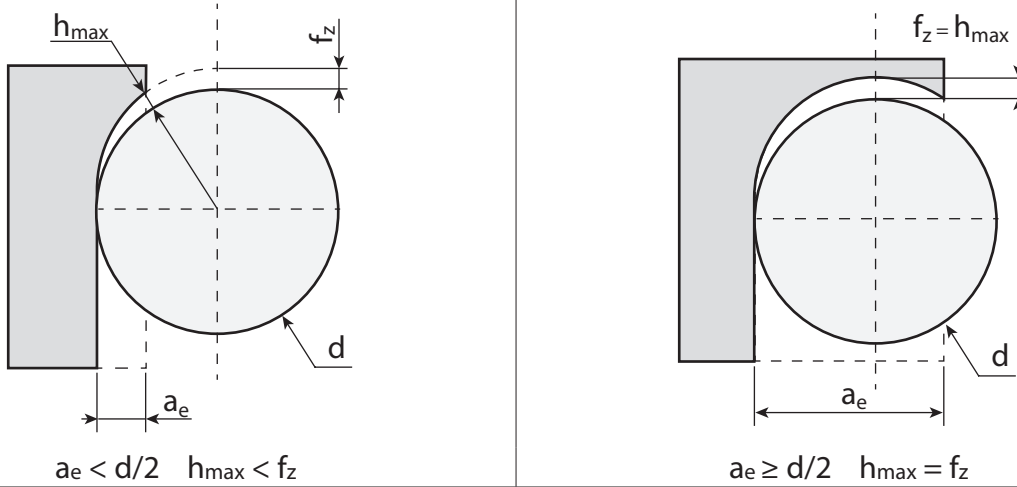

$$h_{max} = 2f_z \sqrt{\frac{a_e}{d} \left(1 - \frac{a_e}{d}\right)}$$

When changing the width of cut the cutting data needs to be adjusted. As calculatory size applies a chip thickness from approx. 0.15–0.2 mm on basis of the usual steel types.

Example

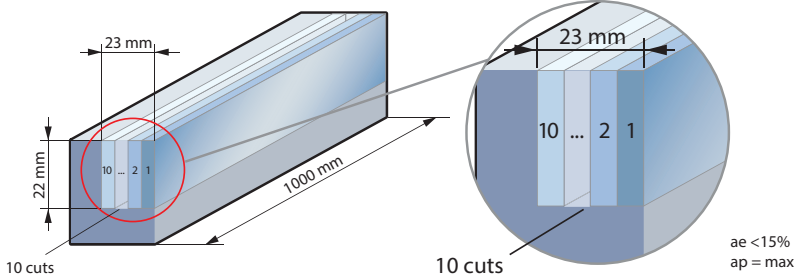
Tool	Machining
 <p>UM-4E-D20.0-W KMG405</p>	 <p>HSC strategy</p>

Workpiece material	16MnCr5 (1.7131) ca. 700 N/mm ³
Cutting data	
V _c	550 m/min
n	8750 U/min
f _z	0.3 mm/z (h_{max} = 0.19 mm)
V _f	10500 mm/min
a _p	22 mm
a _e	2.3 mm

Result

Chip removal rate **530 cm³/min!** Machining time 58 seconds! The maximum chip thickness is 0.19 mm.

A

Turning

B

Milling

C

Drilling

D

Technical Information

E

Index

Solid carbide mills

Feed rate selecting table for profile machining with ball nose cutters and torus mills

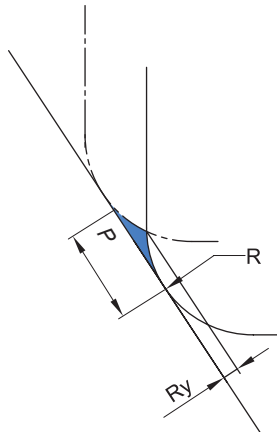

$$R_y = R \times \{1 - \cos [\arcsin(fr/2R)]\}$$

Ry: Theoretical values of surface quality

P: Feed rate

R: Radius of the ball nose cutter or torus mill

R	Ry	Feed rate									
		0.1	0.2	0.3	0.4	0.5	0.6	0.7	0.8	0.9	1.0
0.5		0.003	0.010	0.023	0.042	0.067	0.100				
1.0		0.001	0.005	0.011	0.020	0.032	0.046	0.063	0.083	0.107	
1.5		0.001	0.003	0.008	0.013	0.021	0.030	0.041	0.054	0.069	0.086
2.0		0.001	0.003	0.006	0.010	0.015	0.023	0.031	0.040	0.051	0.064
2.5		0.001	0.002	0.005	0.008	0.013	0.018	0.025	0.032	0.041	0.051
3.0			0.001	0.004	0.007	0.010	0.015	0.020	0.027	0.034	0.042
4.0			0.001	0.003	0.005	0.008	0.011	0.015	0.020	0.025	0.031
5.0			0.001	0.002	0.004	0.006	0.009	0.012	0.016	0.020	0.025
6.0				0.002	0.003	0.005	0.008	0.010	0.013	0.017	0.021
8.0				0.001	0.003	0.004	0.006	0.008	0.010	0.013	0.016
10.0				0.001	0.002	0.003	0.005	0.006	0.008	0.010	0.013
12.5				0.001	0.002	0.003	0.004	0.005	0.006	0.008	0.010

R	Ry	Feed rate									
		1.1	1.2	1.3	1.4	1.5	1.6	1.7	1.8	1.9	2.0
0.5											
1.0											
1.5		0.104									
2.0		0.077	0.092	0.109							
2.5		0.061	0.073	0.086	0.100						
3.0		0.051	0.061	0.071	0.083	0.095	0.109				
4.0		0.038	0.045	0.053	0.062	0.071	0.081	0.091	0.103		
5.0		0.030	0.036	0.042	0.049	0.057	0.064	0.073	0.082	0.091	0.101
6.0		0.025	0.030	0.035	0.041	0.047	0.054	0.061	0.068	0.076	0.084
8.0		0.019	0.023	0.026	0.031	0.035	0.040	0.045	0.051	0.057	0.063
10.0		0.015	0.018	0.021	0.025	0.028	0.032	0.036	0.041	0.045	0.050
12.5		0.012	0.014	0.017	0.020	0.023	0.026	0.029	0.032	0.036	0.040

Nonstandard – solid carbide end mills



Name/Company:	 Wanheimer Str. 57 40472 Düsseldorf, Germany Fax: +49-(0)211-989240-111 E-mail: technik@zccct-europe.com	 <small>Scan for PDF</small>
Address:		
Tel.:		
Fax:		
E-mail:		





Material	
Material	
Tensile strength (N/mm ²)	
Hardness	



Coating	
Yes <input type="checkbox"/>	No <input type="checkbox"/>

Series			
GM		NM	
PM		AL	
UM		VSM	
HM		HPC	

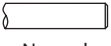
Centre cutting	
Yes <input type="checkbox"/>	No <input type="checkbox"/>

Machining operations		
		
<input type="checkbox"/> Slot milling	<input type="checkbox"/> Square shoulder milling	<input type="checkbox"/> Profile milling

Tool holder type			
DIN6535			
			
Form HA <input type="checkbox"/>	Form HB <input type="checkbox"/>	Normal straight shaft <input type="checkbox"/>	

Type		
		
<input type="checkbox"/> Square shoulder mill	<input type="checkbox"/> Ball nose cutter	<input type="checkbox"/> Torus mill

Number of teeth

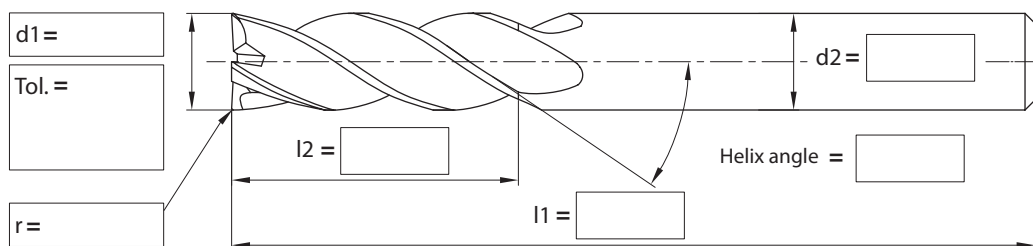

Remarks:	
Order quantity:	Desired delivery date:
Date:	Signature:

Technical information

Comparison table materials	D2-D8
Comparison table hardness and tensile strength	D9-D10
Conversion table chip breaker – turning	D11-D12
Conversion table chip breaker – milling/turning	D13-D21
Example of materials for machining groups	D22
Form test protocol	D23
Torque for screw	D24



A

Turning

B

Milling

C

Drilling

D

Technical
Information

E

Index

Comparison table materials

ISO	Country and standard											
	China	USA	Germany		Great Britain		Sweden	France	Italy	Spain	Japan	Russia
	GB	AISI/SAE	W.-nr	DIN	BS	EN	SS	AFNOR	UNI	UNE	JIS	GOST
P	Alloy steel											
	15	1015	1.0401	C15	080M15	-	1350	CC12	C15C16	F.111	-	-
	20	1020	1.0402	C22	050A20	2C	1450	CC20	C20C21	F.112	-	20
	35	1035	1.0501	C35	060A35	-	1550	CC35	C35	F.113	-	35
	45	1045	1.0503	C45	080M40	-	1650	CC45	C45	F.114	-	45
	55	1055	1.0535	C55	070M55	-	1655	-	C55	-	-	55
	60	1060	1.0601	C60	080A62	43D	-	CC55	C60	-	-	60
	Y15	1213	1.7015	9SMn28	230M07	-	1912	S250	CF9SMn28	11SMn28	SUM22	15Ch
	-	12L13	1.0718	9SMnPb28	-	-	1914	S250Pb	CF9MnPb28	11SMnPb28	SUM22L	-
	-	-	1.0722	10SPb20	-	-	-	10PbF2	CF10Pb20	10SPb20	-	-
	-	1140	1.0726	35S20	212M36	8M	1957	35MF4	-	F210G	-	-
	Y13	1215	1.0736	9SMn36	240M07	1B	-	S300	CF9SMn36	12SMn35	-	-
	-	12L14	1.0737	9SMnPb36	-	-	1926	S300Pb	CF9SMnPb36	12SMnP35	-	-
	55Si2Mn	9255	1.0904	55Si9	250A53	45	2085	55S7	55Si8	56Si7	-	-
	-	9262	1.0961	60SiCr7	-	-	-	60SC7	60SiCr8	60SiCr8	-	-
	15	1015	1.1141	Ck15	080M15	32C	1370	XC12	C16	C15K	S15C	15
	40Mn	1039	1.1157	40Mn4	150M36	15	-	35M5	-	-	-	40G
	25	1025	1.1158	Ck25	-	-	-	-	-	-	S25C	25
	35Mn2	1335	1.1167	36Mn5	-	-	2120	40Mn5	-	36Mn5	SMn438(H)	35G2,35GL
	30Mn	1330	1.1170	28Mn6	150M28	14A	-	20M5	C28Mn	-	SCMn1	30G
	35Mn	1035	1.1183	Cf35	060A35	-	1572	XS38TS	C36	-	S35C	-
	Ck45	1045	1.1191	45	080M46	-	1672	XC42	C45	C45K	S45C	-
	55	1055	1.1203	Ck55	070M55	-	-	XC45	C50	C55K	S55C	55
	50	1050	1.1213	Cf53	060A52	-	1674	XC48TS	C53	-	S50C	-
	60Mn	1060	1.1221	Ck60	080A62	43D	1678	XC60	C60	-	S58C	60,60G
	-	1095	1.1274	Ck101	060A96	-	1870	-	-	-	SUP4	-
	-	-	1.3401	X120Mn12	Z120M12	-	-	X120M12	XG120Mn12	X120Mn12	SCMnH/1	110G13L
	Gr15;45Gr	52100	1.3505	100Cr6	534A99	31	2258	100C6	100Cr6	F.131	SUJ2	SchCh 15
-	ASTM A204Gr.A	1.5415	15Mo3	1501-240	-	2912	15D3	16Mo3KW	16Mo3	-	-	
-	4520	1.5426	16Mo5	1503-245-420	-	-	-	16Mo5	16Mo5	-	-	
-	ASTM A350LF5	1.5622	14Ni6	-	-	-	16N6	14Ni6	15Ni6	-	-	
-	ASTM A353	1.5662	X8Ni9	1501-509;510	-	-	-	X10Ni9	XBNI09	-	-	

Comparison table materials

ISO	Country and standard											
	China	USA	Germany		Great Britain		Sweden	France	Italy	Spain	Japan	Russia
	GB	AISI/SAE	W.-nr	DIN	BS	EN	SS	AFNOR	UNI	UNE	JIS	GOST
P	Alloy steel											
	-	2515	1.5680	12Ni19	-	-	-	Z18N5	-	-	-	-
	-	3135	1.5710	36NiCr6	640A35	111A	-	35NC6	-	-	SNC236	-
	-	3415	1.5732	14NiCr10	-	-	-	14NC11	16NiCr11	15NiCr11	SNC415(H)	-
	-	3415 3310	1.5752	14NiCr14	655M13 655A12	36A	-	12NC15	-	-	SNC815(H)	-
	-	9840	1.6511	36CrNiMo4	816M40	110	-	40NCD3	38CrNiMo4(KB)	35CrNiMo4	-	40 ChN2MA
	-	8620	1.6523	21NiCrMo2	850M20	362	2503	20NCD2	20NiCrMo2	20NiCrMo2	SNCCM220(H)	-
	-	8740	1.6546	40NiCrMo2	311-Type7	-	-	-	40NiCrMo2(KB)	40NiCrMo2	SNC240	38ChGNM
	40CrNiMoA	4340	1.6582	34CrNiMo6	817M40	24	2541	35NCD6	35CrNiMo6(KB)	-	-	38Ch2N2MA
	-	-	1.6587	17CrNiMo6	820A16	-	-	18NCD6	-	14CrNiMo13	-	-
	15Cr	5015	1.7015	15Cr3	523M15	-	-	12C3	-	-	SCr415(H)	15Ch
	35Cr	5132	1.7033	34Cr4	530A32	18B	-	32C4	34Cr4(KB)	35Cr4	SCr430(H)	35Ch
	40Cr	5140	1.7035	41Cr4	530M40	18	-	42C4	41Cr4	42Cr4	SCr440(H)	40Ch
	40Cr	5140	1.7045	42Cr4	-	-	2245	-	-	42Cr4	SCr440	40Ch
	18CrMn	5115	1.7131	16MnCr15	(527M20)	-	2511	16MC5	16MnCr15	16MnCr15	-	18ChG
	20CrMn	5155	1.7176	55Cr3	527A60	48	-	55C3	-	-	SUP9(A)	50ChGA
	30CrMn	4130	1.7218	25CrMo4	1717CDS110	-	2225	25CD4	25CrMo4(KB)	55Cr3	SCM420; SCM430	30ChM
	35CrMo	4137;4135	1.7220	34CrMo4	708A37	19B	2234	35CD4	35CrMo4	34CrMo4	SCM432; SCRMM3	AS38ChGM
	40CrMoA	4140;4142	1.7223	41CrMo4	708M40	19A	2244	42CD4TS	41CrMo4	41CrMo4	SCM440	40 ChFA
	42CrMo 42CrMnMo	4140	1.7225	42CrMo4	708M40	19A	2244	42CD4	42CrMo4	42CrMo4	SCM440(H)	-
	-	-	1.7262	15CrMo5	-	-	2216	12CD4	-	12CrMo4	SCM415(H)	-
	-	ASTM A182 F11;F12	1.7335	13CrMo44	1501- 620Gr.27	-	-	15CD3.5; 15CD4.5	14CrMo44	14CrMo45	-	12ChM, 15ChM
	-	-	1.7361	32CrMo12	722M24	40B	2240	30CD12	32CrMo12	F.124.A	-	-
-	ASTM A182 F22	1.7380	10CrMo910	1501- 622Gr.31;45	-	2218	12CD9;10	12CrMo9,10	TU.H	-	-	
-	-	1.7715	14MoV63	1503-660-440	-	-	-	-	13MoCrV6	-	-	
50CrVA	6150	1.8159	50CrV4	735A50	47	2230	50CV4	50CrV4	51CrV4	SUP10	50ChGFA	
-	-	1.8509	41CrAlMo7	905M39	41B	2940	40CAD6,12	41CrAlMo7	41CrAlMo7	-	38ChMJuA	
-	-	1.8523	39CrMoV139	897M39	40C	-	-	36CrMoV12	-	-	-	

A

Turning

B

Milling

C

Drilling

D

Technical
Information

E

Index

Comparison table materials

ISO	Country and standard											
	China	USA	Germany		Great Britain		Sweden	France	Italy	Spain	Japan	Russia
	GB	AISI/SAE	W.-nr	DIN	BS	EN	SS	AFNOR	UNI	UNE	JIS	GOST
P	Alloy steel											
	T10	W.110	1.1545	C105W1	-	-	1880	Y1105	C98KU C100KU	F.515 F.516	-	U10A
	T12A	W.112	1.1663	C125W	-	-	-	Y2120	C120KU	(C120)	SK2	U13
	CrV;9SiCr	L3	1.2067	100Cr6	BL3	-	-	Y100C6	-	100Cr6	-	-
	Cr12	D3	1.2080	X210Cr12	BD3	-	-	Z200Cr12	X210Cr13KU X250Cr12KU	X210Cr12	SKD1	Ch12
	4Cr5MoVSi	H13	1.2344	X40CrMoV5 1	BH13	-	2242	Z40CDV5	X35CrMoV05KU X40CrMoV51KU	X40CrMoV5	SKD61	4Ch5MF1S
	Cr6WV	A2	1.2363	X100CrMoV5 1	BA2	-	2260	Z100CDV5	X100CrMoV51KU	X100CrMoV5	SKD12	-
	CrWMo	-	1.2419	105WCr6	-	-	2140	105WC13	10WCr6 107WCr5KU	105WCr5	SKS31 SKS2 SKS3	ChWG
	Cr12W	-	1.2436	X210CrW12	-	-	2312	-	X215CrW12 1KU	X210CrW12	SKD2	-
	5CrNiMo	S1	1.2542	45WCrV7	BS1	-	2710	-	45WCrV8KU	45WCrS8	-	-
	3Cr2W8V	H21	1.2581	X30WCrV9 3 X30WCrV93KU	BH21	-	-	Z30WCV9	X28W09KU X30WCrV9 3KU	X30WCrV9	SKD5	3Ch2W8F
	Cr12MoV	-	1.2601	X165CrMoV 12	-	-	2310	-	X165CrMoW12KU	X160CrMoV12	SKD11	-
	5CrNiMo	L6	1.2713	55NiCrMoV6	-	-	-	55NCDV7	-	F.250.S	SKT4	5ChNM
	V	W210	1.2833	100V1	BW2	-	-	Y1105V	-	-	SKS43	-
	W6Mo5Cr4V2Co5	-	1.3243	S6-5-2-5	-	-	2723	Z85WDKCV	HS6-5-2-5	HS6-5-2-5	SKH55	R6M5K5
	W18Cr4VCo5	T4	1.3255	S18-1-2-5	BT4	-	-	Z80WKC 10-05-04-01	X78WCo1805KU	HS18-1-1-5	SKH3	-
	W6Mo5Cr4V2	M2	1.3343	S6-5-2	BM2	-	2722	Z85WDCV 06-05-04-02	X82WMo0605KU	HS6-5-2	SKH9	R6M5
	-	M7	1.3348	S2-9-2	-	-Z-	2782	Z100WCWV 09-02-04-02	HS2-9-2	HS2-9-2	-	-
	W18Cr4V	T1	1.3355	S18-0-1	BT1	-	-	Z80WCV 18-04-01	X75W18KU	HS18-0-1	SKH2	-
	W6Mo5Cr4V3	M3	-	S6-5-3	-	-	-	-	-	-	SKH52	-
-	M42	-	-	BM42	-	-	-	-	-	SKH59	-	

A

Turning

B

Milling

C

Drilling

D

Technical Information

E

Index

Comparison table materials

ISO	Country and standard						Main application
	China	USA	Germany	Japan	Daido Steel Co., Ltd (Japan)	Russia	
	GB	AISI/SAE	DIN	JIS	DAIDO	GOST	
P	Plastic die steel						
	-	P20 mod.		-	PX5N		For mass production of large mirror dies. Automobile tail light, front fender of car, video camera, household electrical appliances etc
	-	-		-	NAK55		High precision mirror die. Video camera, music disc, Cosmetic Containers, transparent covers, transparent films etc
	-	-		-	NAK80		High precision mirror die. Video camera, music disc, Cosmetic Containers, transparent covers, transparent films etc
	3Cr13	420 mod.		SUS420J2 mod.	S-STAR		For ultra-mirror corrosion resistant precise dies. Accessories of camera, CD, lens, watch case.
	Cold-working die steel						
	-	02	-	SKS93	YK30		Stamping die, gauge calipers, paper cutter, auxiliary tools
	9CrWMn	01 mod.	-	SKS3 mod.	GOA		Blanking die, gauge calipers, drawing die, taps, Perforated punch.
	Cr12MoV	D2	X165CrMoV12	SKD11	DC11		Blanking die, cold forming die, cold drawing die, forming roller, punch
	-	D2 mod.	-	SKD11 mod.	DC53		Blanking die, cold forming die, cold drawing die, forming roll, punch
	Hot-working die steel						
	4Cr5MoSiV1	H13	X40CrMoV51	SKD61	DHA1		Aluminum-compression die, connecting parts of compression die, hot stamping die, hot extrusion die, thermal shear cutting blade
	-	-	-	-	DH21		Long life Aluminum compression die
	-	-	-	-	DH31-S		Compression die
	-	-	-	-	DH2F		Compression die, plastic die

A

Turning

B

Milling

C

Drilling

D

Technical Information

E

Index

Comparison table materials

ISO	Country and standard											
	China	USA	Germany		Great Britain		Sweden	France	Italy	Spain	Japan	Russia
	GB	AISI/SAE	W.-nr	DIN	BS	EN	SS	AFNOR	UNI	UNE	JIS	GOST
M	Stainless steel											
	0Cr13; 1Cr12	403	1.4000	X6Cr13	403S17	-	2301	Z6C13	X6Cr13	F.3110	SUS403	08Ch13
	-	-	1.4001	X7Cr14	-	-	-	-	-	F.8401	-	-
	1Cr13	410	1.4006	X10Cr13	410S21	56A	2302	Z10C14	X12Cr13	F.3401	SUS410	12Ch13
	1Cr17	430	1.4016	X6Cr17	430S15	60	220	Z8C17	X8Cr17	F.3113	SUS430	12Ch17
	2Cr13	410	1.4021	X20Cr13	562	56B; 56C	-	Z20C13	X20C13	F.3401	SUS410	20Ch13
	-	-	1.4027	G-X20Cr14	420C29	56B	-	Z20C13M	-	-	SCS2	20Ch13L
	4Cr13	-	1.4034	X46Cr13	420S45	56D	2304	Z40CM Z38C13M	X40Cr14	F.3405	SUS420J2	40Ch13
	1Cr17Ni2	431	1.4057	X20CrNi172	431S29	57	2321	Z15CNi6.02	X16CNi16	F.3427	SUS431	20Ch17N2
	Y1Cr17	430F	1.4104	X12CrMoS17	-	-	2383	Z10CF17	X10CrS17	F.3117	SUS430F	-
	1Cr17Mo	434	1.4113	X6CrMo171	434S17	-	2325	Z8CD17.01	X8CrMo17	-	SUS434	-
	-	-	1.4313	X5CrNi134	425C11	-	-	Z4CND13.4M	-	-	SCS5	-
	-	-	1.4408	G-X6CrNiMo1810	316C16	-	-	-	-	F.8414	SCS14	07Ch18N10G2S2M2L
	4Cr9Si2	HW3	1.4718	X45CrSi93	401S45	52	-	Z45CS9	X45CrSi8	F.322	SUH1	40Ch9S2
	0Cr13Al	405	1.4724	X10CrAl13	403S17	-	-	Z10C13	X10CrAl12	F.311	SUS405	10Ch13SJu
	Cr17	430	1.4742	X10CrAl18	430S15	60	-	Z10CAS18	X8Cr17	F.3113	SUS430	15Ch18SJu
	8Cr20Si2Ni	HNV6	1.4757	X80CrNiSi20	443S65	59	-	Z80CSN20.02	X80CrSiNi20	F.320V	SUH4	-
	2Cr25N	446	1.4762	X10CrAl24	-	-	2322	Z10CAS24	X16Cr26	-	SUH446	-
	Austenitic stainless steel											
	0Cr18Ni9	304	1.4301	X5CrNi1810	304S15	58E	2332	Z6CN18.09	X5CrNi1810	F.3551; F.3541; F.3504	SUS304	08Ch18N10
	1Cr18Ni9MoZr	303	1.4305	X10CrNiS189	303S21	58M	2346	Z10CNF18.09	X10CrNiS18.09	F.3508	SUS303	-
	0Cr19Ni10	304L	1.4306	X2CrNi1911	304S12	-	2352	Z2CN18.10	X2CrNi18.11	F.3503	SCS19	03Ch18N11
	-	-	1.4308	G-X6CrNi189	304C15	-	-	Z6CN18.10M	-	-	SCS13	07Ch18N9L
	Cr17Ni7	301	1.4310	X12CrNi177	-	-	2331	Z12CN17.07	X12CrNi1707	F.3517	SUS301	-
	-	304LN	1.4311	X2CrNi1810	304S62	-	2371	Z2CN18.10	-	-	SUS304LN	-
	0Cr19Ni9	304	1.4350	X5CrNi189	304S31	58E	-	Z6CN18.09	X5CrNi1810	-	SUS304	-
	0Cr17Ni11Mo2	316	1.4401	X5CrNiMo1712	316S16	Z6CND17.11	2347	1.4401	X5CrNiMo1712	F.3543	SUS316	-
	00Cr17Ni13Mo2	316LN	1.4429	X2CrNiMo17133	-	-	2375	Z2CND17.13	-	-	SUS316LN	-
	0Cr27Ni12Mo3	316L	1.4435	X2CrNiMo18143	316S12	-	2353	Z2CDN17.13	X2CrNiMo1713	-	SCS16,	03Ch17N14M2
	00Cr19Ni13Mo3	317L	1.4438	X2CrNiMo17133	317S12	-	2367	Z2CND19.15	X2CrNiMo18.16	-	SUS317L	-
-	329L	1.4460	X8CrNiMo275	-	-	2324	-	-	-	SUS329L; SCH11; SCS11	-	
1Cr18Ni9Ti	321	1.4541	X6CrNiTi1810	2337	321S12	58B	Z6CNT18.10	X6CrNiTi1811	F.3553	SUS321	12Ch18N10T	
1Cr18Ni11Nb	347	1.4550	X6CrNiNb1810	347S17	58F	2338	Z6CNNb18.1	X6CrNiTi1811	F.3552	SUS347	08Ch18N12B	
Cr18Ni12Mo2Ti	316Ti	1.4571	X6CrNiMoTi17122	320S17	58J	2350	Z6NDT17.12	X6CrNiMoTi17	F.3535	-	10Ch17N13M2T	

Comparison table materials

ISO	Country and standard											Russia
	China	USA	Germany		Great Britain		Sweden	France	Italy	Spain	Japan	
	GB	AISI/SAE	W.-nr	DIN	BS	EN	SS	AFNOR	UNI	UNE	JIS	
M	Austenitic stainless steel											
	-	-	1.4581	G-X5CrNiMoNb1810	318C7	-	-	Z4CNDNb1812M	XG8CrNiMo18	-	SCS22	-
	Cr17Ni12Mo3Nb	318	1.4583	X10CrNiMoNb1812	-	-	-	Z6CNDNb1713B	X6CrNiMoTiNb17	-	-	-
	1Cr23Ni13	309	1.4828	X15CrNiSi2012	309S24	-	-	Z15CNS20.1	-	-	SUH309	20Ch20N14S2
	0Cr25Ni20	310S	1.4845	X12CrNi2521	310S24	-	2361	Z12CN2520	X6CrNi2520	F.331	SUH310	20Ch23N18
	Cr15Ni36W3Ti	330	1.4864	X12NiCrSi3616	-	-	-	Z12CNS35.1	-	-	SUH330	-
	-	-	1.4865	G-X40NiCrSi3818	330C11	-	-	-	XG50NiCr3919	-	SCH15	-
	5Cr2Mn9Ni4N	EV8	1.4871	X53CrMnNiN219	349S54; 321S12	-	58B	-	Z52CMN21.0	X53CrMnNiN219	-	SUH35
1Cr18Ni9Ti	321	1.4878	X12CrNiTi189	321S320	58C	-	Z6CNT18.12	X6CrNiTi1811	F.3523	SU321	09Ch18N10T	

ISO	Country and standard										Russia
	China	USA	Germany	Great Britain	Sweden	France	Italy	Spain	Japan		
K	Nodular cast iron										
	QT400-18	60-40-18	GGG40	400/17	0717-02	FGS370-17	GS370-17	FGE38-17	FCD400	VC 42-12	
	QT450-10	65-45-12	--	420/12	--	FGS400-12	GS400-12	FGE42-12	FCD450	-	
	QT500-7	70-50-05	GGG50	500/7	0727-02	FGS500-7	GS500-7	FGE50-7	FCD500	VC 50-2	
	QT600-3	80-60-03	GGG60	600/7	0732-03	FGS600-2	GS600-2	FGE60-2	FCD600	VC 60-2	
	QT700-2	100-70-03	GGG70	700/2	0737-01	FGS700-2	GS700-2	FGE70-2	FCD700	VC 70-2	
	QT800-2	120-90-02	GGG80	800/2	0864-03	FGS800-2	GS800-2	FGE80-2	FCD800	VC 80-2	
	QT900-2	--	--	900/2	--	--	--	--	--	-	
	Grey cast iron										
	--	NO.60	GG40	--	0140	FGL400	--	--	--	Sc 40	
	HT350	NO.50	GG35	350	0135	FGL350	G35	FG35	FC350	Sc 35	
	HT300	NO.45	GG30	300	0130	FGL300	G30	FG30	FC300	Sc 30	
	HT250	NO.35	GG25	250	0125	FGL250	G25	FG25	FC250	Sc 25	
	HT200	NO.30	GG20	200	0120	FGL200	G20	FG20	FC200	Sc 20	
HT150	NO.20	GG15	150	0115	FGL150	G15	FG15	FC150	Sc 15		
HT100	--	--	100	0110	--	G10	--	FC100	-		

ISO	Country and standard											Russia
	China	USA	Germany		Great Britain		Sweden	France	Italy	Spain	Japan	
	GB	AISI/SAE	W.-nr	DIN	BS	EN	SS	AFNOR	UNI	UNE	JIS	
H	Hardened materials											
	-	440A	1.4108	X100CrMo03	-	-	2258 08	-	-	-	C4B5	-
	-	610	1.4111	X100CrMoV15	-	-	2534 05	-	-	-	AC4A	-
	-	0-2	-	X65CrMo14	-	-	2541 06	-	-	-	AC4A	-

Comparison table materials

ISO	Country and standard											
	China	USA	Germany		Great Britain		Sweden	France	Italy	Spain	Japan	Russia
	GB	AISI/SAE	W.-nr	DIN	BS	EN	SS	AFNOR	UNI	UNE	JIS	GOST
N	Aluminium-based alloys											
	-	SC64D	3.2373	G-AISI9MGWA			4251	A-57G			C4BS	-
	-	DG-AISI12		G-ALMG5	LM5		4252	A-SU12			AC4A	
	-	356.1			LM25		4244				A5052	
	-	A413.0		GD-AISI12			4247				A6061	
	-	A380.1		GD-AISI8Cu3	LM24		4250				A7075	
	-	A413.1		G-AISI12(Cu)	LM20		4260				ADC12	
	-	A413.2		G-AISI12	LM6		4261					
-	A360.2		G-AISI10Mg(Cu)	LM9		4253						

ISO	Country and standard											
	China	USA	Germany		Great Britain		Sweden	France	Italy	Spain	Japan	Russia
	GB	AISI/SAE	W.-nr	DIN	BS	EN	SS	AFNOR	UNI	UNE	JIS	GOST
S	Nickel based alloys											
	-	5391	LW2 4670	S-NiCr13A16MoNb	mar-46	-	-	NC12AD	-	-		
	-	AMS 5397	LW2 4674	NiCo15Cr10MoAlTi	-	-	-	-	-	-		
	-	5660	LW2.4662	NiFe35Cr14MoTi	-	-	-	ZSNCDT42	-	-		
	-	5383	LW2.4668	NiCr19Fe19NbMo	HR8	-	-	NC19eNB	-	-		
	-	-	2.4631	NiCr20TiAk	Hr401.601	-	-	NC20TA	-	-		-
	-	AMS 5399	2.4973	NiCr19Co11MoTi	-	-	-	NC19KDT	-	-		-
	-	AMS 5544	LW2.4668	NiCr19Fe19NbMo	-	-	-	NC20K14	-	-		
	-	5390A	2.4603	-	-	-	-	NC22FeD	-	-		-
	-	5666	2.4856	NiCr22Mo9Nb	-	-	-	NC22FeDNB	-	-		-
	-	-	2.4630	NiCr20Ti	HR5.2034	-	-	NC20T	-	-		-
	-	4676	2.4375	NiCu30AL3Ti	3072-76	-	-	-	-	-		-
	Cobalt based alloys											
	-	5537C AMS		CoCr20W15Ni	-	-	-	KC20WN	-	-		
	-	5772	LW2.4964	CoCr20W14Ni				KC22WN				
	Titanium alloys											
	-	UNS R54520	3.7115.1	TiAl5Sn2.5	TA14/17	-	-	T-A5E	-	-		
	-							UNS R56400				
	-	-	3.7165.1	TiAl6V4	TA10-13/ TA28		-	UNS R56401	T-A6V	-	-	
	-			TiAl5V5Mo5Cr3								
-	-	3.7185	TiAl4Mo4Sn4Si0.5	-	-	-	-	-	-			

A

Turning

B

Milling

C

Drilling

D

Technical Information

E

Index

Comparison table hardness and tensile strength

Hardness				Tensile strength N/mm ²	Hardness				Tensile strength N/mm ²
Rockwell Hardness		Vickers Hardness	Brinell Hardness		Rockwell Hardness		Vickers Hardness	Brinell Hardness	
HRC	HRA	HV	HB		HRC	HRA	HV	HB	
70.0	86.6	1037	—	—	51.0	76.3	525	501	1780
69.5	86.3	1017	—	—	50.5	76.1	517	494	1750
69.0	86.1	997	—	—	50.0	75.8	509	488	1720
68.5	85.8	978	—	—	49.5	75.5	501	481	1690
68.0	85.5	959	—	—	49.0	75.3	493	474	1660
67.5	85.2	941	—	—	48.5	75.0	485	468	1630
67.0	85.0	923	—	—	48.0	74.7	478	461	1605
66.5	84.7	906	—	—	47.5	74.5	470	455	1575
66.0	84.4	889	—	—	47.0	74.2	463	449	1550
65.5	84.1	872	—	—	46.5	73.9	456	442	1525
65.0	83.9	856	—	—	46.0	73.7	449	436	1500
64.5	83.6	840	—	—	45.5	73.4	443	430	1475
64.0	83.3	825	—	—	45.0	73.2	436	424	1450
63.5	83.1	810	—	—	44.5	72.9	429	418	1430
63.0	82.8	795	—	—	44.0	72.6	423	413	1405
62.5	82.5	780	—	—	43.5	72.4	417	407	1385
62.0	82.2	766	—	—	43.0	72.1	411	401	1360
61.5	82.0	752	—	—	42.5	71.8	405	396	1340
61.0	81.7	739	—	—	42.0	71.6	399	391	1320
60.5	81.4	726	—	—	41.5	71.3	393	385	1300
60.0	81.2	713	—	2555	41.0	71.1	388	380	1280
59.5	80.9	700	—	2500	40.0	70.8	382	375	1260
59.0	80.6	688	—	2450	40.0	70.5	377	370	1245
58.5	80.3	676	—	2395	39.5	70.3	372	365	1225
58.0	80.1	664	—	2345	39.0	70.0	367	360	1210
57.5	79.8	653	—	2295	38.5	—	362	355	1190
57.0	79.5	642	—	2250	38.0	—	357	350	1175
56.5	79.3	631	—	2205	37.5	—	352	345	1160
56.0	79.0	620	—	2160	37.0	—	347	341	1140
55.5	78.7	609	—	2115	36.5	—	342	336	1125
55.0	78.5	599	—	2075	36.0	—	338	332	1110
54.5	78.2	589	—	2035	35.5	—	333	327	1095
54.0	77.9	579	—	1995	35.0	—	329	323	1080
53.5	77.7	570	—	1955	34.5	—	324	318	1065
53.0	77.4	561	—	1920	34.0	—	320	314	1050
52.5	77.1	551	—	1885	33.5	—	316	310	1035
52.0	76.9	543	—	1850	33.0	—	312	306	1020
51.5	76.6	534	—	1815	32.5	—	308	302	1010

A

Turning

B

Milling

C

Drilling

D

Technical
Information

E

Index

Comparison table hardness and tensile strength

Hardness					Tensile strength N/mm ²	Hardness					Tensile strength N/mm ²
Rockwell Hardness		Vickers Hardness	Brinell Hardness			Rockwell Hardness		Vickers Hardness	Brinell Hardness		
HRC	HRA	HV	HB			HRC	HRA	HV	HB		
32.0	—	304	298		995	24.0	—	249	245		820
31.5	—	300	294		980	23.5	—	246	242		810
31.0	—	296	291		970	23.0	—	243	240		800
30.5	—	292	287		960	22.5	—	240	237		790
30.0	—	289	283		950	22.0	—	237	234		785
29.5	—	285	280		935	21.5	—	234	232		775
29.0	—	281	276		920	21.0	—	231	229		765
28.5	—	278	273		910	20.5	—	229	227		760
28.0	—	274	269		900	20.0	—	226	225		750
27.5	—	271	266		890	19.5	—	223	222		745
27.0	—	268	263		880	19.0	—	221	220		735
26.5	—	264	260		870	18.5	—	218	218		730
26.0	—	261	257		860	18.0	—	216	216		725
25.5	—	258	254		850	17.5	—	214	214		715
25.0	—	255	251		835	17.0	—	211	211		710
24.5	—	252	248		830						

Note: The conversion values for steel in the table are commonly applicable for the steels with carbon from low to high.

A

Turning

B

Milling

C

Drilling

D

Technical
Information

E

Index

Conversion table chip breakers – turning

ISO	Application	ZCC-CT		Sandvik		Seco		Kennametal		ISCAR		Walter		Mitsubishi		Sumitomo		Tungaloy		Kyocera		Korloy		Ingersoll Tague Tec		
		Neg	Pos	Neg	Pos	Neg	Pos	Neg	Pos	Neg	Pos	Neg	Pos	Neg	Pos	Neg	Pos	Neg	Pos	Neg	Pos	Neg	Pos	Neg	Pos	
P	Wiper-finishing	WG		WF WL	WF WK	W-MF2	W-F1	FW MW	FW MW	WF		NF	PF	SW	FW	NLU-W	NLU-W	ASW		WP		VW LW		WS		
	Finishing	DF EF	SF HF	PF QF	PF UF 23	FF1 MF1	FF1 F1	FF FN	11 UF LF	SF		FF FS	FH FS	EJ FV	NSE NSU NLU NFA NEL	NLU NFP NFK	PF 01	DP GP VF	CF		VG VF VL	VF		FG FC VF	FA SA FG	
	Semi-finishing	DM EM	HM	PM QM	PM UM	MF2	F2	FN	MF		NF TF SM	14 16 17 19	P55	SH SA	SW SV MV	NSX	TSTMA S	P5	HQ CQ CJ	CK DP GP VF XP	VQ VC VB	HMP		WT ML	WT	
	Medium machining to light roughing	DM PM	HR	PM QM	PR UR	M3 MF3	F2	MN	MF		GN PP NR	17 19	PM5	MV MZ MA	MV MW	NMU NSF	PM	GS GS HS PS	HQ XQ GK G	VM				PC MC MT MG MF	PC MT PMR	
	Wiper-medium			WR WM	WM	W-M3 W-R4 W-R7	W-F2	MW RW	MW		WG		NM	MW		NGU-W		WQ								
	Roughing	DR		PR QR 31		M5 MR5 MR7		RP UN RN			TNM GN	19		GH MAT MT		NMU NMX		PT GT HT	G St-form			HR			RT	
	Single side roughing	HDR 31HPR DR LR		HR QR		R8 RR9 -56 -57 -LUX		RH RM RP			NM		NR6 NR8	HA HZ HH HV HX		NMP NHG NHP NHU NHW		HX				GH VH VT			HT HD HY HZ RX RH	CMX
	Wiper-finishing	WG		WF WL WMX	WF WK	W-MF2		FW MW	FW MW		WF		PF	SW	FW	NLU-W										
	Finishing	EF DF	EF HF	MF	MF UF	FF1 F2 MF1	F1	FF FP	11 UF LF		NF VL	PF SM	NF4	PF4 PF5	F5	EJ FV	NSU NLU	SS	SS	SS	GU				EA SF	FG
	Semi-finishing	EF EM	EF EM HF HM	MF MM	MF UM	MF3	F2	FP	MF		PP TF	14 16 17 19	NM4	SH MS MV	SW SV MV	NEX NUP		SS SM	PS	MS	MS	CK DP GP VF XP	VP2	HMP		
Medium machining to light roughing	EM DM	EM HM	MM	MM UM	R6 S6	F2	MP	HP		PP TF	17 19	NM4 NR4	MS ES MH	MV MW	NGU	PM	SA S	MS			HQ XQ GK G	HS VP3	C25	EM SU MT	MT PMR WT	
Wiper medium			WR WM	WM	W-M3		MW RW	MW		WG			MW		NGU -W											
Roughing	ER DR	HR	MR QR PR	MR	R7 R8		MP-P			HTW NR	19	NR4	GH HZ		NMU NMX NHG						VM			ET	CMX	
Single side roughing	ER DR HDR LR		HR QR		-56		RP			NM					NMP NHG NHP NHU NHW											



Conversion table chip breakers – turning

ISO	Application	ZCC-CT		Sandvik		Seco		Kennametal		ISCAR		Walter		Mitsubishi		Sumitomo		Tungaloy		Kyocera		Korloy		Ingersoll Tague Tec	
		Neg	Pos	Neg	Pos	Neg	Pos	Neg	Pos	Neg	Pos	Neg	Pos	Neg	Pos	Neg	Pos	Neg	Pos	Neg	Pos	Neg	Pos	Neg	Pos
K	Wiper-Finishing	WG		WF	WF	W-MF2	W-F1	FW/MW	FW/MW	WF							NLU-W	NLU-W							
	Finishing	DF	HF	KF	KF	F1	F1	FF FN	11 UF LF	NF SM	14 19	PS5				NSU	NSU	C			VM				
	Semi-finishing	PM	HM	KF KM	KF KM	M3	F2	FN	MF	GN	14 19	NM5	PM5	GH	NUX NGU	NSU	CM	C Stand. form			B25	HMP			
	Medium machining to light roughing	DR	HM HR	KM QM	KM	M3	F2	UN	HP	GN NR		NM6	PM5		NUZ NGU NMU	NMU	CM	GC ZS			VK GR	C25	MT MG	MT PMR WT	
N	Wiper medium					W-M3 W-R4 W-R7		MW	MW	WG		NM	PM		NGU-W										
	Roughing	DR +NMA	HR	KR QR	KR UR	M5				NR		NR6		GH	NMU			ZS			MA		RT	CMX	
	Finishing		LC		AL				LF	NF			PM2												
	Semi-finishing		LC		AL		AL	GP		NF PP	AS											HA	AK	FL SA	
S	Medium machining to light roughing		LH		AL		AL	GG-FS MS	HP	NMS													AR		
	Finishing	NF EF	NF	NGP	MF	MF1		FS	GT-HP	SF PF	PF SM	PF4		FJ	NSU	NSU									
	Semi-finishing	NF NM EM	NF	23	MM	MF1 M1		FS MS	GT-MF	SF PF	PF SM	PF5		MJ	NEX NUP	NSU NSK							AK		
	Medium machining to light roughing	NM EM		MF	MM UM	M1		MS	MT-LF	PP TF		PS5	MS		NMU	NSK							HMP	SU	
Heat-resistant alloys	Roughing	ER		SR		MR3 MR4		RP		TF HTW NR				GJ									VM		

Conversion table grades – turning

Coated cemented carbide CVD

ISO	ZCC-CT	Sandvik	Kennametal	Sumitomo	Mitsubishi	Toshiba Tungaloy	Kyocera	Walter	Iscar	SECO	Korloy	Ingersoll Tague Tec	Widia			
P	Steel	P01-05	GC4205 GC4305	KCP05 KC9105	AC805P	UE6005 UE6105	T9005 T9105	CA5505	WPP01 WPP05	IC8150 IC9150 IC428	TP0500 TP0501					
		P10-15	GC4315 GC4215	KCP10 KC9110	AC810P AC700G	UC6110 MY5015	T9015 T9115	CA510 CA5515 CA510	WPP10 WPP10S	IC8150 IC8250 IC9150 IC9250 IC9015	TP1500 TP1501	NC3010	TT8115 TT8125	WP15CT		
		P20-25	GC4325 GC4225 GC4025	KCP25 KC9125	AC820P AC8020P AC900G AC2000	UE6020 MC6025	T9025 T9125	CA5525 CA525 CR9025	WPP20 WPP20S	IC8150 IC8250 IC9250 IC9025	TP2501 TP2500 TP200	NC3220 NC3120	TT8125 TT3500	WP25CT		
		P30-35	GC4335 GC4235 GC4035	KCP30 KC8050	AC830P AC3000	UE6035 UE6400	T903 T9135	CA530 CA5535 CA535	WPP30 WPP30S	IC8250 IC8350 IC9350	TP3500	NC3030 NC5330 NC500H	TT5100 TT8135	WP35CT		
		M	Stainless steel	M10	GC2015 GC1515	KCM15	AC610M	MC7015	T9115		IC8250 IC9250 IC6015			TT9215	WM15CT	
				M20	GC2015 GC2025	KCM25 KC9225	AC610M AC650M	US7020 MC7015 MC7025	T6020 T6120 T9125	CA6515	WAM20	IC8250 IC9350 IC9025 IC6025	TM 2000 TP200 TP2500	NC9025	TT5100 TT9225	WM25CT
				M30	GC2025 GC2035	KCM25 KCM35 KC9225	AC630M AC6030M AC830P AC3000	US735 US7025	T6030 T6130	CA6525	WAM30	IC8350 IC9350 IC9025	TP3500 TM 4000		TT5100 TT7100 TT9235	WM35CT
		K	Cast Iron	M40	GC2035	KCM35 KC9240 KC9245	AC630M AC6030M AC830P AC3000	US735	CA6525		IC6025 IC9350	TP 40		TT5100 TT7100 TT9235	WK05CT	
				K01-05	GC3005 GC3205	KCK05	AC405K AC410K	UC5005 UC5105	T5105	CA4505		IC5005 IC9007		NC6205	TT1300 TT7005	WK05CT
				K10-15	GC3215	KCK15 KC9315	AC410K AC415K AC420K AC700G	MC5015 UC5115 MY5015	T5105 T5115	CA4010 CA4515 CA4115	WAK10 WAK10S	IC9015 IC9007 IC8150 IC5010 IC428 IC4028 IC9150	TK1001 TK1000	NC6210	TT1300 TT7310 T7015	WK20CT
K20-25	GC3225	KCK20 KC9320	AC420K AC900G	MC5015 UC5115 UE6110 MY5015	T5125 T9125	CA4125	WAK20 WKK20S	IC5010 IC428 IC4028 C9150	TK2000 TK2001	NC5330		WK20CT				

A

Turning

B

Milling

C

Drilling

D

Technical Information

E

Index



Conversion table grades – turning

Coated cemented carbide PVD

ISO	ZCC-CT	Sandvik	Kennametal	Sumitomo	Mitsubishi	Toshiba Tungaloy	Kyocera	Walter	Iscar	SECO	Korloy	Ingersoll Tague Tec	Widia
P	P01-05	GC1105					PR1005						
	P10-15	GC1515 GC1115 GC1025	KC5010 KC5510 KC7215 KC7315	AC510U	VP10MF VP15TF	AH710	PR930 PR1005 PR930 PR115	WSM10 WXN10	IC520N IC507 IC570 IC807 IC907 IC908				
	P20-25	GC1515 GC1125 GC1025	KC5025 KC5525 KU25T	AC520U	VP20RT VP20MF	AH725 AH120	PR930 PR1025 PR1225	WSM20 WMP205 WSM21	IC228 IC250 IC308 IC828 IC350 IC354 IC507 IC807 IC808 IC907 IC908 IC928 IC1008 IC1028 IC3028	CP200 CP250 TP2000 TS2500		TT8020 TT9020	
P30-35	GC1125 GC2035	KC7335	AC530U		SH730 J740 GH130 AH740	PR660	WSM30	IC228 IC250 IC328 IC330 IC354 IC528 IC1008 IC1028 IC3028	CP500	PC5300			
M	M10	GC1105 GC1115 GC1025 GC1125 GC1515	KCU10 KC5010 KC5510 KC6005 KC6015	EH10Z ACS10U ACS30U	VP10MF	AH710	PR915 PR1005	WSM10	IC330 IC354 IC507 IC520 IC570 IC807 IC1028 IC3028	CP500 TS2000	PC8110	TT5080	WS10PT
	M20	GC1025 GC1125	KC501 KCU25	AC520U ACS30U	VP10RT VP15TF VP20RT VP20MF	AH120 AH725 SH730 AH710 AH630 GH330	PR1025 PR1125 PR1225	WSM10 WMP205 WSM20 WSM21	IC228 IC250 IC354 IC808 IC908 IC1008 IC1028 IC3028	TS2000 TS2500 CP200 CP250		TT8020 TT9020 TT9080	WS25PT
M30	YBG302	GC2035	KC5025 KCU25		VP10RT VP15TF VP20RT MP7035	AH12 AH725 SH730 AH710 AH630 GH330 J740	PR1025 PR1125 PR1225	WSM20 WSM21 WSM30	IC228 IC250 IC328 IC330 IC1008 IC1028 IC3028	CP500 TS2500	PC5300 PC9030		
S05		S05F			MP9005	AH905			IC507 IC907				
S	S10	GC1105 GC1115	KC5010 KCU10 KC5510 KC510	AC510U EH510Z	MP9015 VP10RT	AH905 SH730 AH110 AH120		WSM10	IC507 IC807 IC808 IC907	CP200 CP250 TS2000 TS2500	PC8110	TT5080	WS10PT
	S20	GC1025 GC1125 GC1515	KC5010 KCU10 KC5025 KCU25 KC5525	AC520U EH520Z	MP9015 MT9015 VP20RT	AH120 AH725	PR1125	WSM20 WSM21 WSM30	IC507 IC807 IC907	CP250 TS2500 CP500	PC5300	TT5080 TT8020 TT9080	WS25PT
S30	YBG302			AC520U	VP15TF	AH725	PR1125	WSM30	IC3028 IC808 IC830		PC5400	TT8020	
N	N10	GC1515	KC5410					WXN10	IC520				

Conversion table grades – turning

Cermet

ISO	ZCC-CT	Sandvik	Kennametal	Sumitomo	Mitsubishi	Toshiba Tunggaloy	Kyocera	Walter	Iscar	SECO	Korloy	Ingersoll Tague Tec	Widia	
P	P01-05	CT5005		T110A T1000A	AP25N VP25N	NS520 AT520 GT520 GT720	TN30 TN6010 PV30 PV7010		IC20N IC520N		CN1000 CC105	CT3000 PV3010		
	P10-15	CT5015 CT530	KT315 KT125	T1200A T2000Z T1500A T1500Z	NX2525 AP25N VP25N	NS520 NS730 GT730 PV60 NS9530 GT9530	TN60 TN6010 PV60 PV6010		IC20N IC520N IC530N	CM TP1020 TP1030 CMP	CN1000 CT10 CN2000 CC115	CT3000 PV3010	TT115	
	P20-25	GC1525	KT325 KT1120 KT5020	T1200A T2000Z T1500A T1500Z	NX2525 NX3035 AP25N VP25N MP3025	NS530 NS730 GT730 NS9530 GT9530	TN60 IC30N PV60 PV7020 PV7025		IC20N IC30N IC75T IC520N IC530N	CM TP1020 TP1030 CMP	CN20 CN2000 CC115			TT115
	P30-35			T3000Z	MP3025 VP45N		PV7025 PV90		IC75T					
M	M10	GC1525	KT125	T110A T1000A T1500Z T2000Z	NX2525 AP25N VP25N	NS520 AT530 GT530 GT720	TN60 TN6020 PV60 PV7020			CM TP1020 TP1030 CMP		CT3000 PV3010	TT115	
	M20	CT5015 CT530	HT2	T110A T1000A T1500Z T2000Z	NX2525 AP25N VP25N	NS530 GT730 NS730	TN90 TN6020 PV90 PV7020 PV7025					CT3000 PV3010	TT115	
	M30			T3000Z										
	M40													
K	K01-05			T110A T1000A T2000Z T1500Z	NX2525 AP25N	NS520 GT730 NS730	TN30 TN6010 PV30 PV7005 PV7010				CN1000	CT3000 PV3010		
	K10-15	CT5015	KT325 KT125	T1200A T1500A T2000Z T1500Z	NX2525 AP25N	NS520 GT730 NS730	TN60 TN6020 PV60 PV7020 PV7025				CN1000	CT3000 PV3010		
	K20-25	CT5015		T3000Z	NX2525 AP25N									

A

Turning

B

Milling

C

Drilling

D

Technical Information

E

Index

Conversion table grades – turning

Uncoated carbide

ISO	ZCC-CT	Sandvik	Kennametal	Sumitomo	Mitsubishi	Toshiba Tungaloy	Kyocera	Walter	Iscar	SECO	Korloy	Ingersoll Tague Tec	Widia
N Non-ferrous metals	N01	H10 H13A	KF1	H1		KS05F				883 890			
	N10	H10 H13A	K313 KF1 THM-F	H1	HT110	KS15F	KW10	WK01 WK10	IC20	890 KX HX	H01	K10	THM
	N20	H10 H13A	K313 KF1 THM-F			KS15F	KW15		IC20	KX HX			

A

Turning

B

Milling

C

Drilling

D

Technical Information

E

Index

Conversion table grades – milling

CVD milling grades

Material / Class	ZCC-CT	Sandvik	Kennametal	Sumitomo	Mitsubishi	Toshiba Tunggaloy	Kyocera	Walter	Iscar	SECO	Korloy	Ingersoll Tague Tec
P	P05	K20W GC4220		F7010								
	P10	K20W GC3040 GC4220 GC4230		ACP100	F7010				IC4100 IC5100	MP1500	NC5330 NCM325	IN6505 IN6520
	P20	GC3040 GC4230		CS3000	FH7020	T3130		WKP25 WKP255	IC4050 IC4100 IC5100 IC5400	MP1500 MP2500 MS2500 T25M	NC5330 NCM325	IN6505 IN6520 IN7035
	P30	GC2040 GC4240	KC930M KC935M	CS3000	F7030	T3130		WKP35 WKP355 WTP35	IC4050 IC5400	MK3000 T25M T350M	NCM325	IN7035 IN6530
	P40	GC2040 GC4240								T350M		IN6530
	M10	GC4230		F7010						MP1500	NCM325 NC5330	IN6520
	M20	GC4230		F7020	F7020	T3130			IC4050	MP1500 MP2500 MS2500 T25M	NCM325 NCM335	IN7035 IN6520 IN6505
	M30	GC2040 GC4240	KC930M KC935M	F7030	F7030	T3130		WTP35		MP2500 MS2500 T25M T350M	NCM335	IN6530 IN7035 IN6505
	M40	GC2040 GC4240								T350M		IN6530
	K	K05		KCK15	F7010 MC5020					DT7150 IC4100		
K10		K20W	KCK15	ACK200	F7010 MC5020	T1115		WAK15	DT7150 IC4100 IC4010	MP1500 MK1500	NC5330	IN6520
K20		K20W		ACK200		T1115		WKP25 WKP255	DT7150 IC4100	MP1500 MP2500 MS2500 T25M MK1500	NC5330	IN6530 IN6515 IN6520
K30			KC930M KC935M					WKP35 WKP355	IC4050	MK3000 MP2500 MS2500		IN6530 IN6515

A

Turning

B

Milling

C

Drilling

D

Technical Information

E

Index

Conversion table grades – milling

CVD milling grades

Material / Class	S05	S10	S20	S30	N05	N10	N20	H05	H10	H20
S Heat-resistant alloys										
ZCC-CT										
Sandvik				GC2040					K20W	K20W GC3040
Kennametal										
Sumitomo										
Mitsubishi										
Toshiba Tungaloy										
Kyocera										
Walter				WTP35						
Iscar										
SECO	MK3000		MP2500 MS2500 T25M	MM4500 T350M			MP2500 25M			
Korloy										
Ingersoll Tague Tec			IN7035 IN6520							
N Non-ferrous metals										
H Hardened materials										

Conversion table grades – milling

PVD milling grades

Material / Class	ZCC-CT	Sandvik	Kennametal	Sumitomo	Mitsubishi	Toshiba Tunggaloy	Kyocera	Walter	Iscar	SECO	Korloy	Ingersoll Tague Tec
P Steel	P05			ACZ120	VP05HT	GH130			IC903			IN2004 IN2006
	P10	GC1010 GC1025 GC1020	KC522M KC525M KC610M KC643M KC715M	ACZ10M ACZ20W	VP10H	AH120 GH130	PR730 PR1225 PR1525	WXH15 WHH15 WXM15	IC903 IC950 IC1008	F15M		
	P20	GC1020 GC1025 GC1010 GC2030	KC522M KC525M KC643M KC715M KC725M	ACP200 ACZ330 ACX70 ACW30 AC350 ACZ50M	VP15TF VP20M VP20RT	AH725 AH120 AH130 AH330 AH725 AH730 GH330	PR630 PR830 PR730 PR1225 PR1230 PR1525	WXM15	IC810 IC380 IC830 IC900 IC908 IC910 IC950 IC1008	F25M MP3000	PC3500 PC3600	IN2006 IN1030 IN2004 IN2005 IN2015 IN2030 IN2505 IN2540
	P30	GC1030 GC2030	KC530M KC725M KC735M	ACP200 ACP300 ACZ50M ACZ330 ACZ350 ACX70 ACW30 AC350	VP30RT	AH740 AH130 AH140	PR630 PR660 PR830 PR1230	WXM35	IC300 IC328 IC830 IC900 IC928 IC350 IC808 IC908	F30M MP3000	PC3500 PC3600 PC3300 PC3545 PC9570T	IN1030 IN2005 IN2015 IN2030 IN2035 IN2040 IN2505 IN2530 IN4035
	P40	GC1030	KC735M	ACP300 ACZ350		AH140 AH750		WXP45 WSP45 WSP46	IC300 IC328 IC928	F40M	PC5300 PC3545	IN2035 IN2040
	M10	GC1020	KC522M KC610M KC643M KC715M	ACZ20W ACZ350 EH20Z	AH330 GH110 GH130	PR730 PR1225 PR660 PR1525		PR730 PR660 PR1025 PR1225 PR1525	PR730 PR660 PR1025 PR1225 PR1525	F15M	PC8110	IN2505
	M20	GC1020 GC1025 GC1030 GC203	KC522M KC525M KC610M KC715M KC725M	ACP200 ACZ50M ACZ20M ACZ350 EH20Z AC350	VP15TF VP20RT	AH725 AH730 GH110	PR730 PR1025 PR660 PR1225 PR1525	WXM15		F25M MP3000	PC5300 PC8110 PC9530	IN2005 IN2015 IN2505
	M30	GC1040 GC203	KC525M KC530M KC725M KC735M	ACP300 ACZ50M ACX80 AC350	VP30RT	AH740 AH120 AH130 GH330 GH340		WXM35 WXM36 WXM35		F30M MP3000	PC9530 PC3545 PC9570T	IN1030 IN2015 IN2030 IN2035 IN2530 IN4035
	M40	GC1040	KC530M KC735M	ACP300 ACX80		AH140 AH750 GH330 GH340				F40M	PC3545	IN1030 IN2030 IN2035 IN2530 IN4035
	K05	GC1010	KC510M	ACZ10M ACZ120 ACZ310	AH330	PR905 PR1210 PR1510				MH1000	PC8110	IN2510
K10	GC1010	KC510M KC520M KC620M KC643M	EH20Z ACZ310	AH120 AH330 AH725	PR905 PR1210 PR1510		WXH15 WHH15 WXM15	IC810 IC950 IC1008	F15M MK2000	PC6510	IN2004 IN2010 IN2510	
K20	GC1020	KC520M KC620M KC725M	ACK300 EH20Z ACX80 ACW30	GH130			WKK25	IC328 IC830 IC950 IC350 IC808 IC908 IC1008	F25M MK2000 MO3000	PC6510 PC5300	IN1030 IN2004 IN2010 IN2015 IN2030 IN2505	
K30	GC1020	KC620M KC725M	ACK300 ACZ50M					IC328 IC830 IC900 IC908 IC350 IC808 IC908	F30M F40M MP3000	PC5300 PC9570T	IN2005 IN2015 IN2030 IN2505	



Conversion table grades – milling

PVD milling grades

Material / Class	ZCC-CT	Sandvik	Kennametal	Sumitomo	Mitsubishi	Toshiba Tungaloy	Kyocera	Walter	Iscar	SECO	Korloy	Ingersoll Tague Tec
S Heat-resistant alloys	S05	YBG102								MH1000 F15M	PC8110	
	S10	YBG102 YBG202 YBG205	KC525M KC643M	ACZ20W	VP15TF		PR905 PRI210 PRI1510		IC808	NH1000 F15M F25M	PC5300	
	S20	YBG202 YBG205	KC525M KC643M	ACZ20W			PR905 PRI210 PRI1510		IC908 IC380 IC900 IC903 IC908 IC928 IC830 IC808	F25M F30M	PC5300 PC3545	IN2005 IN2505
	S30		KC725M KC735M	ACZ50M				WSM35 WSM36 WSP45 WSP46 WXM35 WXP45	IC328 IC928 IC830	F40M	PC3545	IN1030 IN2030 IN2035 IN2530 IN4035
N Non-ferrous metals	N05		KC510M							MH1000 F15M		
	N10	YBG202	KC510M KC620M KC522M	EH20Z				WXN15		MH1000 F15M		
	N20		KC620M KC522M KC525M KC651M							F25M F30M F40M MP3000		
H Hardened materials	H05				VP05HT				IC903	MH1000 F15M	PC210F	IN2004 IN2006
	H10	YBG102	KC643M		VP10MF			WXH15 WHH15	IC900 IC808	MK2000 F30M MP3000	PC210F	IN2004 IN2005 IN2006
	H20	YBG202	GC1010 GC1025 GC1030		VP15TF				IC810 IC908	F30M F40M MK2000 MP3000		

Conversion table grades – milling

Uncoated milling grades

ISO	ZCC-CT	Sandvik	Kennametal	Sumitomo	Mitsubishi	Toshiba Tungaloy	Walter	Kyocera	Iscar	SECO	Korloy	Ingersoll Tague Tec
N	N01	H10	K115M K110M				WK10		IC20N		H01	IN04S
	N10		K313	EH520	HT10		WKM	GW25	IC08	H15	G10	IN10K IN05S
	N20	H13A H10F	KMF	EH520	TF15		KMG40		IC28	H25		IN15K
Non-ferrous metals												

A

Turning

B

Milling

C

Drilling

D

Technical
Information

E

Index

Examples of materials for machining groups

Material No.	Material	Machining group
1.0722	10SPb20	1
1.0715	9SMn28	1
1.0736	9SMn36	1
1.0718	9SMnPb28	1
1.0737	9SMnPb36	1
1.0401	C15	1
1.0402	C22	1
1.1141	Ck15	1
1.1170	28Mn6	2
1.0726	35S20	2 / 3
1.1167	36Mn5	2 / 3
1.1157	40Mn4	2 / 3
1.0501	C35	2 / 3
1.0503	C45	2 / 3
1.1191	Ck45	2 / 3
1.1183	Cf35	2 / 3
1.1213	Cf53	2 / 3
1.1545	C 105 W1	4 / 5
1.1663	C 125 W	4 / 5
1.0535	C55	4 / 5
1.0601	C60	4 / 5
1.1274	Ck101	4 / 5
1.1203	Ck55	4 / 5
1.1221	Ck60	4 / 5
1.5710	36NiCr6	5 / 9
1.5120	38MnSi 4	5 / 9
1.1545	C 105 W2	4 / 5
1.1663	C 125 W	4 / 5
1.0535	C65	4 / 5
1.0601	C70	4 / 5
1.1274	Ck101	4 / 5
1.1203	Ck55	4 / 5
1.1221	Ck60	4 / 5
1.5710	36NiCr7	5 / 9
1.5120	38MnSi 5	5 / 9
1.1545	C 105 W3	4 / 5
1.1663	C 125 W	4 / 5
1.0535	C75	4 / 5
1.0601	C80	4 / 5
1.1274	Ck101	4 / 5
1.1203	Ck55	4 / 5
1.1221	Ck60	4 / 5
1.5710	36NiCr8	5 / 9
1.5120	38MnSi 6	5 / 9
1.1545	C 105 W4	4 / 5
1.1663	C 125 W	4 / 5
1.0535	C85	4 / 5
1.0601	C90	4 / 5
1.1274	Ck101	4 / 5

Material No.	Material	Machining group
1.1203	Ck55	4 / 5
1.1221	Ck60	4 / 5
1.5710	36NiCr9	5 / 9
1.5120	38MnSi 7	5 / 9
1.1545	C 105 W5	4 / 5
1.1663	C 125 W	4 / 5
1.0535	C95	4 / 5
1.0601	C100	4 / 5
1.1274	Ck101	4 / 5
1.1203	Ck55	4 / 5
1.1221	Ck60	4 / 5
1.5710	36NiCr10	5 / 9
1.5120	38MnSi 8	5 / 9
1.5680	12Ni19	10 / 11
1.3255	S 18-1-2-5	10 / 11
1.3348	S 2-9-2	10 / 11
1.3343	S 6-5-2	10 / 11
1.3243	S 6-5-2-5	10 / 11
1.2363	X 100 CrMoV 5-1	10 / 11
1.2601	X165CrMoV12	10 / 11
1.2080	X210 Cr 12	10 / 11
1.2581	X30WCrV 9-3	10 / 11
1.2344	X40CrMoV 5-1	10 / 11
1.4718	X45CrSi9-3	10 / 11
1.3355	S 18-0-1	10 / 11
1.4027	G-X20Cr14	12 / 13
1.4006	X12 Cr 13	12 / 13
1.4104	X12CrMoS 17	12 / 13
1.4057	X19CrNi 17-2	12 / 13
1.4034	X46Cr 13	12 / 13
1.4871	X53 CrMnNiN 21-9	12 / 13
1.4113	X6CrMo 17	12 / 13
1.4000	X6CR 13	12 / 13
1.4001	X7Cr14	12 / 13
1.4016	X6Cr17	12 / 13
1.4581	G-X5CrNiMoNb 18	14
1.4308	G-X6CrNi 18-9	14
1.4408	G-X6CrNiMo 18-10	14
1.4583	X6CrNiMoNb 18-12	14
1.4571	X6CrNiMoTi 17-12-2	14
1.4550	X6CrNiNb 18-10	14
1.4541	X14CrNiTi 18-10	14
1.4845	X12CrNi 25-21	14
1.4310	X10CrNi 18-8	14
1.4305	X10CrNiS 18-10	14
1.4878	X12CrNiTi 18-9	14
1.4317	X2CrNi 18-8	14
1.4436	X3CrNiMo 17-13-3	14
1.4440	X2CrNiMo 18-16	14

Material No.	Material	Machining group
1.4429	X2CrNiMoN 17-13-3	14
1.4311	X2CrNiN 18 10	14
1.4301	X5CrNi 18-10	14
1.4401	X5CrNiMo 17-12-2	14
0.6010	GG10	16
0.6015	GG15	16
0.6020	GG20	16
0.6025	GG25	16 / 17
0.6030	GG30	17
0.6035	GG35	17
0.6040	GG40	17
1.4829	X12NiCrSi 22-12	17
1.4828	X15CrNiSi20-12	17
0.7033	GGG35.3	18
0.7040	GGG40	18
0.7043	GGG40.3	18
0.8135	GTS-35	18
0.7050	GGG50	19
0.7060	GGG60	19
0.7070	GGG70	19
0.7660	GGGNiCr 20-2	19
0.7652	GGGNiMn 13-7	19
0.8155	GTS-55	21
0.8165	GTS-65	21
0.8170	GTS-70	21
0.8145	GTS-45	21
3.0205	Al99	22
3.3315	AlMg 1	22
3.1325	AlCuMg 1	23
3.2315	AlMgSi 1	23
3.2581	G-ALSi12	24
3.2163	G-ALSi9Cu3	24
3.2381	G-ALSi10Mg	25
2.0375	CuZn36Pb 3	27
2.1096	G-CuSn5ZnPb	27
2.0590	G-CuZn40Fe	27
2.0240	CuZn15	28
2.0060	E-Cu 57	29
1.4865	G-X40NiCrSi 38-18	30
1.4864	X12NiCrSi 36-16	30
2.4631	NiCr20TiAl	32
2.4856	NiCr22Mo9Nb	32
2.4375	NiCu30Al	33
2.4955	NiFe25Cr20NbTi	33
2.4764	CoCr20W15Ni	34
1.3401	G-X120Mn12	34
3.7165	TiAl6V4	36

A

Turning

B

Milling

C

Drilling

D

Technical Information

E

Index

Test protocol

ZCC Cutting Tools Europe GmbH

Date:			
General	End User	Distributor	
Company			
Contact person			
Machine			
Type			
Producer			
Power [kW]			
Tooling system			
Work piece			
Material			
Hardness/Tensile strength [N/mm ²]			
Heat treatment/Surface			
Interrupt cutting			
Cutting tools			
Producer (holder)			
Toolholder (name)			
Teeth Z			
Producer/Supplier			
Insert type/Tool number			
Grade			
Solid carbide tools number			
Cooling			
Cutting Data			
RPM n [U/min]			
Cutting speed Vc [m/min]			
Feed rate f [mm/rpm]			
Feed rate Vf [mm/min]			
Depth of cut a _p [mm]			
Width of cut a _e [mm]			
Machining length [mm]			
Cutting time T [min]			
Results			
Machined pieces/Edges			
Surface quality			
Flankwear VB			
Criteria			
Notch wear			
Crater wear			
Plastic deformation			
Built-up edge			
Insert breakage			
Cutting edge breakage			
Chip forms			

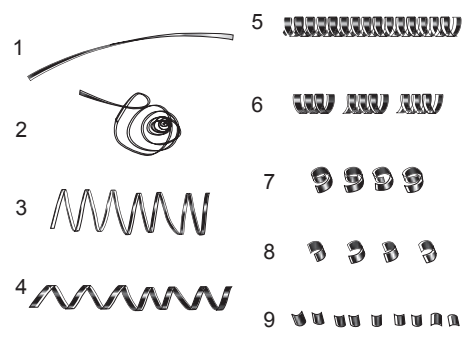

--	--	--	--

Conclusion:

Fax: +49-(0)211-989240-111
E-mail: technik@zccct-europe.com

Signature:

A
Turning
B
Milling
C
Drilling
D
Technical Information
E
Index

A

Torque for screw

Thread	M1,6	M1,8	M2	M2,2	M2,5	M3	M3,5	M4	M4,5	M5	M6	M7	M8	M10	M12
Torque [Nm]	0,2	0,3	0,4	0,7	0,8	1,5	2,3	3,4	5,0	6,7	11,4	19,2	27,0	55,8	85

Turning

B

Milling

C

Drilling

DTechnical
Information**E**

Index

Index

Inserts

E2-E5

Tools

E6-E8

E

A

Turning

B

Milling

C

Drilling

D

Technical
Information

E

Index

A

Turning

B

Milling

C

Drilling

D

Technical Information

E

Index

1

175.32-22	A99
175.32-24	A99
175.32-25	A99
175.32-28	A99
175.32-31	A99

A

ANGX*PNR-GM	B117
	B119
	B121
	B123
	B125
ANGX*PNR-LH	B117
	B119
	B121
	B123
	B125
APKT-ALH	B95
	B98
	B101
	B104
	B106
	B195
APKT-APF	B95
	B98
	B101
	B104
	B106
	B195
APKT-APM	B95
	B98
	B101
	B104
	B106
	B195
APKT-KM	B169
	B171
	B173
APKT-LH	B95
	B98
	B101
	B104
	B106
	B195

APKT-PF	B95
	B98
	B101
	B104
	B106
	B195
APKT-PM	B95
	B98
	B101
	B104
	B106
	B195
APKT-PR	B95
	B98
	B101
	B104
	B106
	B195
APMT	B108

C

CCGT (PCD)	A162
CCGT-SF	A102
CCGT-USF	A102
CCGW (PCBN)	A152
CCGX-LC	A108
CCGX-LH	A108
CCMT-AHF	A103
CCMT-EF	A105
CCMT-EM	A105
CCMT-HF	A103
CCMT-HM	A106
CCMT-HR	A107
CCMT-TC	A107
CCMW	A107
CNE-A/B	B165
CNEG-NF	A44
CNGA (PCBN)	A146
CNGN (PCBN)	A157
CNGX (Ceramic)	A178
CNMA	A52
CNMG	A52
CNMG-ADF	A43
CNMG-DF	A43
CNMG-DM	A45
CNMG-DR	A47
CNMG-EF	A43
CNMG-EG	A45
CNMG-EM	A45
CNMG-ER	A49

CNMG-NM	A47
CNMG-PM	A44
CNMG-SF	A43
CNMG-SNR	A48
CNMG-TC	A47
CNMG-WG	A43
CNMG-ZM	A46
CNMM	A51
CNMM-DR	A49
CNMM-ER	A49
CNMM-HDR	A51
CNMM-HPR	A51
CNMM-LR	A50
CPGT	A104
CPGT-SF	A109
CPGW	A109
CPMT-HF	A109
CPMT-HM	A109

D

DCGT (PCD)	A164
DCGT-SF	A110
DCGT-USF	A111
DCGW (PCBN)	A153
DCGX-LC	A114
DCGX-LH	A115
DCMT-AHF	A110
DCMT-EF	A112
DCMT-EM	A112
DCMT-HF	A112
DCMT-HM	A113
DCMT-HR	A114
DCMW	A114
DNEG-NF	A56
DNEG-NGF	A56
DNGA (PCBN)	A147
DNGN (PCBN)	A158
DNGX (Ceramic)	A181
DNMA	A59
DNMG	A61
DNMG-ADF	A53
DNMG-DF	A53
DNMG-DM	A54
DNMG-DR	A58
DNMG-EF	A56
DNMG-EG	A57
DNMG-EM	A57
DNMG-ER	A59
DNMG-FM	A56
DNMG-NM	A57

DNMG-PM A54
 DNMG-SF A53
 DNMG-SNR A58
 DNMG-TC A57
 DNMG-ZM A55
 DNMM-DR A60
 DNMM-ER A60
 DNMM-HDR A60
 DNMM-LR A60
 DPGT-SF A116
 DPGT-USF A116
 DPMW A116

H

HNEX-DF B63
 HNEX-DM B63
 HNEX-DR B63
 HNGX-HDR B203
 HNGX-MR B203

K

KNUX A98

L

LNCX B206
 LNE32.302 B204
 LNE32.534 B205
 LNKT-GM B111
 LNKT-ZR B113
 B65
 B73
 B80

M

MPHT-DM B148
 B150
 B167

O

OFKR-DF B39
 OFKR-DM B39
 OFKR-LH B39
 OFKT-DF B37
 OFKT-DM B37

OFKT-LH B37
 ONHU-GM B53
 ONHU-PF B43
 B45
 ONHU-PM B43
 B45
 ONHU-W B43
 B46

P

PNEG-CF B57
 B60
 PNEG-CM B57
 B60
 PNEG-CR B57
 B60
 PNEG-PF B58
 B60
 PNEG-PM B58
 B60
 PNEG-PR B58
 B60

Q

QC**R/L A367
 QC**R/L***R A370

R

R/LT****N-A(G) A413
 R/LT****N-A(G)B A430
 R/LT****N-AC A424
 R/LT****N-AP A426
 R/LT****N-BPTB A435
 R/LT****N-BSPT A417
 R/LT****N-BSPTB A434
 R/LT****N-BUT A428
 R/LT****N-GM A411
 R/LT****N-GMB A429
 R/LT****N-NPT A418
 R/LT****N-NPTF A419
 R/LT****N-R A420
 R/LT****N-RT A427
 R/LT****N-STAC A425
 R/LT****N-TR A423
 R/LT****N-UN A416
 R/LT****N-UNB A433
 R/LT****N-W A415

R/LT****N-WB A432
 R/LT****W-A(G) A413
 R/LT****W-A(G)B A430
 R/LT****W-AC A424
 R/LT****W-AP A426
 R/LT****W-BPTB A435
 R/LT****W-BSPT A417
 R/LT****W-BSPTB A434
 R/LT****W-BUT A428
 R/LT****W-GM A411
 R/LT****W-GMB A429
 R/LT****W-MJ A421
 R/LT****W-NPT A418
 R/LT****W-NPTF A419
 R/LT****W-R A420
 R/LT****W-RT A427
 R/LT****W-STAC A425
 R/LT****W-TR A423
 R/LT****W-UN A416
 R/LT****W-UNB A433
 R/LT****W-UNJ A422
 R/LT****W-W A415
 R/LT****W-WB A432
 RCGT A117
 RCGX-LH A117
 B82

RCKT-DM B84
 B82
 B85
 RCKT-DR B82
 B85
 B82
 B85
 RCKT-NM B82
 B85
 RCMT A117
 RCMW (PCBN) B85
 RCMX A118
 RDKW B89
 B93
 B198
 B200
 RNGN (PCBN) A161
 RNMG A97
 ROHX B130

S

SCGX-LC A121
 SCGX-LH A122
 SCMT A121
 SCMT-AHF A119

A

Turning

B

Milling

C

Drilling

D

Technical Information

E

Index



A

Turning

SCMT-EF	A119
SCMT-EM	A119
SCMT-HF	A120
SCMT-HM	A120
SCMT-HR	A121
SDMT	B128
SDMT-DM	B157

B

Milling

SDMT-PM	B157
	B159
	B191
SEEN	B34
SEET-CF	B28
	B31
SEET-CM	B28
	B31
SEET-CR	B28
	B31
SEET-DF	B28
	B31
SEET-DM	B28
	B31
SEET-DR	B28
	B31
SEET-EF	B28
	B31
SEET-EM	B28
	B31
SEET-LH	B28
	B31
SEET-PF	B78
SEET-PM	B78
SEET-PR	B78
SEET-W	B29
	B32
SEKN	B35
SEKR	B35
SNEG-E	B49
SNEG-GM	B49
SNEG-GR	B49
SNEG-W	B50

C

Drilling

SEET-DM	B28
	B31
SEET-DR	B28
	B31
SEET-EF	B28
	B31
SEET-EM	B28
	B31
SEET-LH	B28
	B31
SEET-PF	B78
SEET-PM	B78
SEET-PR	B78
SEET-W	B29
	B32

D

Technical Information

SEET-W	B29
	B32
SEKN	B35
SEKR	B35
SNEG-E	B49
SNEG-GM	B49
SNEG-GR	B49
SNEG-W	B50
SNGA (PCBN)	A148
SNGN (PCBN)	A159
SNGX (Ceramic)	A183
SNKN	B207
SNMA	A74
SNMG	A73
SNMG-ADF	A62
SNMG-DF	A62
SNMG-DM	A65
SNMG-DR	A67

E

Index

SNMG-EF	A63
SNMG-EG	A65
SNMG-EM	A66
SNMG-ER	A68
SNMG-NM	A67
SNMG-PM	A64
SNMG-SF	A62
SNMG-TC	A66
SNMM	A73
SNMM-DR	A69
SNMM-HDR	A71
SNMM-HPR	A72
SNMM-LR	A70
SNUN	A76
SPAN	B208
SPCN	B208
SPEX-1	B71
SPGN	B211
SPGT-EM	C19
SPGT-PM	C19
SPKN	B58
	B70
SPKR	B71
SPKR-GM	B71
SPKT	B67
SPKW	B67
SPMR	B209
SPMT	B128
	B175
	B177
	B179
	B181
	B183
	B185
SPMT-HT	B210
SPMT-KM	B169
	B171
	B173
SPMT-KT	B210
SPMT-PM	B169
	B171
	B173
SPMW	A123
SPUN	B211

T

TBGH	A124
TCGT (PCD)	A166
TCGT-SF	A125
TCGT-USF	A125

TCGW (PCBN)	A154
TCGX-LC	A130
TCGX-LH	A130
TCMT	A129
TCMT-AHF	A126
TCMT-EF	A127
TCMT-EM	A127
TCMT-HF	A126
TCMT-HM	A128
TCMT-HR	A128
TCMW	A128
TNGA (PCBN)	A149
TNGN (Ceramic)	A186
TNMA	A87
TNMG	A86
TNMG-ADF	A77
TNMG-DF	A77
TNMG-DM	A80
TNMG-DR	A83
TNMG-EF	A79
TNMG-EG	A82
TNMG-EM	A82
TNMG-ER	A84
TNMG-FM	A79
TNMG-PM	A80
TNMG-SF	A78
TNMG-TC	A82
TNMG-ZM	A81
TNMM	A87
TNMM-DR	A84
TNMM-HDR	A85
TNMM-LR	A84
TNMX	A100
TNMX-WG	A77
TPAN	B212
TPCN	B212
TPGH	A131
TPGT-SF	A131
TPKN	B75
	B213
TPMR	B214
TPUN	B214

V

VBET-NF	A138
VBET-NGF	A140
VBGT (PCD)	A168
VBGT-HR	A140
VBGT-SF	A139
VBGW (PCBN)	A155

VBMT-AHF	A138
VBMT-EF	A138
VBMT-EM	A140
VBMT-HF	A138
VBMT-HM	A140
VBMT-HR	A141
VBMT-SNR	A141
VBMW	A141
VC GT	A133
VC GT-HF	A132
VC GT-NF	A132
VC GT-SF	A132
VC GT-USF	A133
VC GW (PCBN)	A156
VC GX-LC	A134
VC GX-LH	A135
VC MT-EF	A136
VC MT-EM	A136
VNEG-NF	A88
VNEG-NGF	A89
VNGA (PCBN)	A150
VNMG	A90
VNMG-ADF	A88
VNMG-DF	A88
VNMG-DM	A90
VNMG-EF	A88
VNMG-EM	A90
VNMG-NM	A90
VNMG-SF	A89
VNMG-TC	A91
VNMG-ZM	A91
VP GT-USF	A137

W

WCMX-53	A142
	C20
WCMX-D	C20
WCMX-PG	C20
WNEG-NF	A93
WNGA (PCBN)	A151
WNGN (PCBN)	A160
WNMA	A96
WNMG-ADF	A92
WNMG-DF	A92
WNMG-DM	A94
WNMG-DR	A96
WNMG-EF	A93
WNMG-EG	A94
WNMG-EM	A94
WNMG-NF	A93

WNMG-NM	A96
WNMG-PM	A95
WNMG-SF	A92
WNMG-TC	A96
WNMG-WG	A93
WNMG-ZM	A95
WPGT	B161
	B163
	B193
WPGT-PM	B161
	B163
	B193

X

XPHT-GM	B132
	B134
	B136
	B138
	B189
XSEQ	B144
	B146

Y

YNMX	A101
YNUX	A101

Z

ZDET	B127
ZDET-PM	B127
ZIGQ-NM	A363
ZILD-LC	A365
ZIMF-NM	A362
ZOHX-GF	B140
	B142
	B202
ZOHX-GM	B140
	B142
	B202
ZP*D-MG-R/L	A354
ZP*S-MG	A353
ZPD-MG	A352
ZPNT	B127
ZR*D-EG	A361
ZR*D-LH	A364
ZR*D-MG	A360
ZT*D-EG	A357
ZT*D-MG	A355

ZT*D-MM	A351
ZT*S-MG	A356

A

Turning

B

Milling

C

Drilling

D

Technical
Information

E

Index

A

Turning

B

Milling

C

Drilling

D

Technical Information

E

Index

1

1101SC05	C110
1105SC03	C107
1143SC120	C120
1143SC90	C119
1165PA03	C112
1534SH03	C106
1534SP03C	C87
1534ST03C	C92
1534SU03	C30
1534SU03C	C30
1536ST05C	C96
1536SU05	C41
1536SU05C	C41
1538SU08C	C51
1557SU03	C70
1576PC05	C116
1576PC05C	C116
1579PC15C	C118
1588SL10C	C72
1588SL12C	C75
1588SL15C	C79
1588SL20C	C82
1588SL30C	C85
1634SU03C	C54
1636ST05C	C100
1636SU05C	C58
1734SU03C	C62
1736SU05C	C66

3

3101H7	C131
3102H7	C132
3103H7	C134
3112H7	C133

4

4111	C159
4122A	C145
4122M	C148
4201A	C155
4201C	C151
4202A	C157
4202C	C153
4222A	C146
4222M	C149

5

5501/5601	B418
5501R302GM	B262
5501R303GM	B278
5501R304GF	B292
5501R38414GM	B394
5502R302GM	B264
5502R303GM	B280
5502R304GF	B294
5502R38414GM	B395
5502R38414GM-R	B398
5502R402NM	B368
5502R453GM	B282
5502R55MHH	B352
5508R454GM	B296
5565R302GF	B301
5565R302NH	B385
5566R302GF	B303
5566R302NH	B386
5589R45MGFR02	B298
5601	B420
5601R302GM	B263
5601R303GM	B279
5601R304GF	B293
5601R38414GM	B396
5602R302GM	B266
5602R303GM	B281
5602R303GR	B315
5602R304GF	B295
5602R304GR	B316
5602R305GR	B317
5602R38414GM	B397
5602R38414GM-R	B399
5602R453GM	B283
5602R454GM	B297
5665R202GM	B302

A

A***-PCLNR/L	A284
A***-PDSNR/L	A286
A***-PDUNR/L	A287
A***-PSKNR/L	A289
A***-PTFNR/L	A290
A***-SCLCR/L	A293
A***-SDQCR/L	A295
A***-SDUCR/L	A296
A***-SDZCR/L	A297
A***-SSKCR/L	A298
A***-STFCR/L	A300

A***-SVQBR/L	A304
A***-SVUBR/L	A305
AL-2B	B387
AL-2E	B376
AL-2EL	B377
AL-2R-AIR	B388
AL-2RL-AIR	B389
AL-3E	B379
AL-3EL	B380
AL-3R-AIR	B391
AL-3RL-AIR	B392
AL-3W	B384
ALG-2E	B378
ALG-2R	B390
ALG-3E	B381
ALP-3E	B382
ALP-4E	B383

B

BMR01	B126
BMR02	B129
BMR03	B131
BMR04	B139

C

C***-SCLPR/L	A312
C***-SDQPR/L	A314
C***-SDUPR/L	A316
C***-STUPR/L	A318
C***-SVQCR/L	A321
C***-SVUCR/L	A322
C40X-Q*DR/L	A394
CCLNR/L	A258
CDJNR/L	A260
CKJNR/L	A256
CKNNR/L	A257
CMA01	B178
CMD01	B182
CMZ01	B174
CRDNN	A264
CSDNN	A265
CSKNR/L	A262
CSRNR/L	A263
CTJNR/L	A259
CTUNR/L	A261

D

DCLNR/L	A197
DDJNR/L	A198
DSBNR/L	A199
DTGNR/L	A200
DVJNR/L	A202
DVVNN	A201
DWLNRL	A203

E

E***-SCLCR/L	A313
E***-SCLPR/L	A312
E***-SDQCR/L	A315
E***-SDUCR/L	A317
E***-STFCR/L	A319
E***-STFPR/L	A320
E***-SVUCR/L	A322
EMP01	B94
EMP02	B100
EMP03	B103
EMP04	B105
EMP05	B107
EMP09	B110
EMP13	B116

F

FMA01	B27
FMA02	B30
FMA03	B33
FMA04	B36
FMA07	B44
FMA11	B48
FMA12	B52
FMD02	B56
FMD03	B64
FME02	B66
FME03	B68
FME04	B72
FMP01	B74
FMP02	B76
FMP03	B79
FMR01	B81
FMR02	B83
FMR03	B86
FMR04	B90

G

GM-2B	B304
GM-2BFP	B306
GM-2BL	B305
GM-2BP	B308
GM-2BS	B307
GM-2E	B267
GM-2EFP	B270
GM-2EL	B268
GM-2EP	B273
GM-2ES	B275
GM-2EX	B269
GM-2F	B271
GM-2FL	B272
GM-2R	B312
GM-3E	B276
GM-3EL	B277
GM-4B	B310
GM-4BL	B311
GM-4E	B288
GM-4E-G	B289
GM-4EFP	B291
GM-4EL	B290
GM-4EL-G	B285
GM-4EX-G	B287
GM-4F-G	B284
GM-4FL-G	B286
GM-4R	B313
GM-4RL	B314
GM-4W	B318
GM-6E	B299
GM-6EL	B300
GQC**R/L	A397

H

HM-2B	B355
HM-2BFP	B357
HM-2BL	B356
HM-2BP	B359
HM-2BS	B358
HM-2E	B344
HM-2EFP	B345
HM-2EP	B346
HM-2ES	B348
HM-4B	B361
HM-4BL	B362
HM-4E	B349
HM-4EFP	B351
HM-4EL	B350

HM-4R	B363
HM-4RF	B364
HM-4RP	B365
HM-6E	B353
HM-6EL	B354
HMP01	B168
HMP01-EC	B172

J

JCLNR/L	A266
JDJNR/L	A267
JSDNN	A268

M

MCBNR/L	A218
MCLNR/L	A219
MDJNR/L	A220
MDPNN	A221
MRDNN	A233
MRGNR/L	A234
MSBNR/L	A222
MSDNN	A225
MSKNR/L	A224
MSRNR/L	A223
MTFNR/L	A229
MTGNR/L	A226
MTJNR/L	A227
MVJNR/L	A231
MVVNN	A230
MWLNRL	A232

N

NM-2B	B372
NM-2BP	B373
NM-2E	B369
NM-2EP	B370
NM-4E	B371

P

PCBNR/L	A204
PCLNR/L	A205
PDJNR/L	A206
PDNNR/L	A207
PM-2B	B329
PM-2BC	B332
PM-2BFP	B331

A

Turning

B

Milling

C

Drilling

DTechnical
Information**E**

Index

A

Turning

PM-2BL	B330
PM-2E	B320
PM-2EL	B321
PM-2R	B337
PM-4B	B335
PM-4BL	B336
PM-4E	B325
PM-4E-G	B322
PM-4EL	B326
PM-4EL-G	B323
PM-4EX-G	B324
PM-4H	B338
PM-4HL	B339
PM-4R	B340
PM-4RL	B341
PM-6E	B327
PM-6EL	B328
PSBNR/L	A208
PSDNN	A210
PSKNR/L	A211
PSSNR/L	A212
PTFNR/L	A213
PTGNR/L	A215
PTTNR/L	A214
PWLNR/L	A217

B

Milling

C

Drilling

Q

Q*DR/L	A395
QCH-APKT	B194
QCH-RD	B197
QCH-RDKW	B199
QCH-SDMT	B190
QCH-WPGT	B192
QCH-XPHT	B188
QCH-ZOHX	B201
QE**R/L	A376
QE*S**N	A382
QE*SN30	A378
QE*SR/L	A381
QEBDR/L	A376
QECDR/L	A379
QF**R/L	A384
QF**RR/LL	A386
QF*DRR/LL	A390
QX**R/L	A380
QZS*	A383

D

Technical Information

E

Index

S

S***-PCLNR/L	A284
S***-PDSNR/L	A286
S***-PDUNR/L	A287
S***-PSKNR/L	A289
S***-PTFNR/L	A290
S***-PWLNR/L	A291
S***-SCFCR/L	A310
S***-SCLCR	A311
S***-SCLCR/L	A293
S***-SCLPR/L	A306
S***-SDQCR/L	A295
S***-SDQPR/L	A307
S***-SDUCR/L	A296
S***-SDUPR/L	A308
S***-SDZCR/L	A297
S***-SSKCR/L	A298
S***-STFCR/L	A300
S***-STUPR/L	A309
S***-SVQBR/L	A304
S***-SVQCR/L	A302
S***-SVUBR/L	A305
S***-SVUCR/L	A303
S*K-QC**R/L	A398
SCACR/L	A235
SCACR/L-SC	A272
SCLCR/L	A236
SCLCR/L-SC	A273
SDACR/L	A237
SDACR/L-SC	A274
SDHCR/L-SC	A275
SDJCR/L	A238
SDJCR/L-SC	A276
SDNCN	A239
SDNCN-SC	A277
SMP01	B143
SMP03	B147
SMP05	B151
SNL	A440
SNR	A439
SRDCN	A254
SRGCR/L	A255
SSBCR/L	A245
SSDCN	A246
SSKCR/L	A247
SSSCR/L	A248
STACR/L	A249
STFCR/L	A250
STGCR/L	A251
STTCR/L	A252

SVABR/L	A241
SVACR/L-SC	A278
SVJBR/L	A240
SVJCR/L	A244
SVJCR/L-SC	A279
SVVBN	A242
SVVCN	A243
SWACR/L	A253
SWL	A438
SWR	A437

T

TMP01	B166
-------	------

U

UM-4E	B402
UM-4E-W	B403
UM-4EFP	B407
UM-4EL	B404
UM-4EL-W	B405
UM-4ELP-W	B406
UM-4R	B408
UM-4RFP	B410
UM-4RL	B409

V

VSM-4E	B412
VSM-4E-C	B413
VSM-4R	B414

X

XMP01	B164
XMR01	B158

Z

ZD03	C16
ZTD02	C8
ZTD03	C10
ZTD04	C12
ZTD05	C14







The Company

Zhuzhou Cemented Carbide Cutting Tools Co., Ltd. (ZCC-CT) is located in Zhuzhou, Hunan province, China and is the largest supplier of carbide tools into the Chinese market. The ZCC-CT cutting tool company is part of the "Zhuzhou cemented carbide Group" who manufacture carbide materials and powders. Both of these companies are part of the "Minmetals Corporation" who mine and produce raw tungsten carbide materials.

Since its foundation in 1953 ZCC-CT has developed rapidly by progressively using highly advanced modern production technology as well as having a highly qualified and committed workforce. With over 2,000 employees the company is now the largest producer of carbide cutting tools in China and one of the leading carbide manufacturers worldwide.

Using this advanced production technology, ZCC-CT products are manufactured to the highest quality standards to maintain a constant quality and high performance. The wide range of products contains indexable carbide inserts (coated and uncoated), inserts of Cermets, CBN, PCD and ceramics, solid carbide cutting tools as well as tool holders and milling bodies. The products are produced to various international standards such as ISO DIN, ANSI, JIS and BSI. Furthermore customised and special carbide product are also offered.

Research and development plays a major and significant role at ZCC-CT. The production facilities use the most sophisticated and advanced equipment available and this is supplied by the leading machine and equipment manufacturers in Germany and Switzerland. A highly qualified and skilled team of engineers in the R&D departments are constantly developing new and improved cutting tools. There is a constant desire to continually enhance the quality, to fulfill the ever increasing market requirements for new and initiative products and to achieve the best possible result for the customers.

The production and administration facilities in China are certified to ISO 9001:2000 and they maintain strict environmental management to ISO 14001:2004 standards.

Since 2003 ZCC Cutting Tools has operated a sales organisation in Europe. This sales and warehousing subsidiary of ZCC-CT is based in Düsseldorf (Germany) and has been progressively build up and expanded by Mr. Quanliang Zhao the European Managing Director.

Sales to all European countries, as well as Russia and Turkey, are controlled and managed from this European central warehouse in Düsseldorf, with the majority of the products being dispatched on the same day of ordering. The business operates under the quality management system for "Distribution and Logistics of Metal Cutting Tools" and is certified with DIN EN ISO 9001:2008.

ZCC Cutting Tools Europe has a constantly growing number of employees covering sales, marketing, warehouse and distribution, technical support, IT, HR and accounting. Our external sales team and our partners from around Europe are there to support you on-site in your production facilities or distribution operations. Our internal, highly qualified, technical application engineering staff are always available to give the customer technical advice and support via telephone, by email or in person. The internal sales team takes care of your enquiries and orders and together with dedicated warehouse staff they ensure that products are dispatched to you as quickly as possible.

The complete team at ZCC Cutting Tools Europe are there to support you and be your competent and efficient partner in the global Cutting Tool Industry.



Sales center in Europe

ZCC Cutting Tools Europe GmbH

www.zccct-europe.com

Wanheimer Straße 57 40472 Düsseldorf, Germany

Tel.: +49(0)211-989240-0

Fax: +49(0)211-989240-111

E-mail: info@zccct-europe.com

Sales center in France

ZCC Cutting Tools France S.A.S.

www.zccct-europe.com

14, Allée Charles Pathé, 18000 Bourges, France

Tel.: +33 (0)2-454101-40

Fax: +33 (0)2-486619-46

E-mail: ventes@zccct-europe.com



© Copyright by ZCC Cutting Tools Europe GmbH
All rights reserved.